**SK 602N, SK 622N****de** Einbau- und Betriebsanleitung**en** Installation and operating instructions**fr** Notice de montage et de mise en service**it** Istruzioni di montaggio, uso e manutenzione**el** Οδηγίες εγκατάστασης και λειτουργίας**tr** Montaj ve kullanma kılavuzu**hu** Beépítési és üzemeltetési utasítás**pl** Instrukcja montażu i obsługi**cs** Návod k montáži a obsluze**ru** Инструкция по монтажу и эксплуатации**ro** Instrucțiuni de montaj și exploatare

Fig. 1:

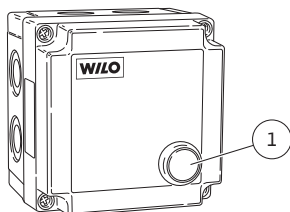

Fig. 2:

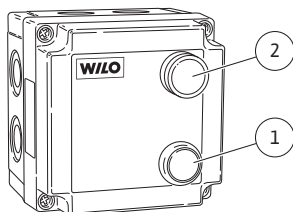

Fig.3a:

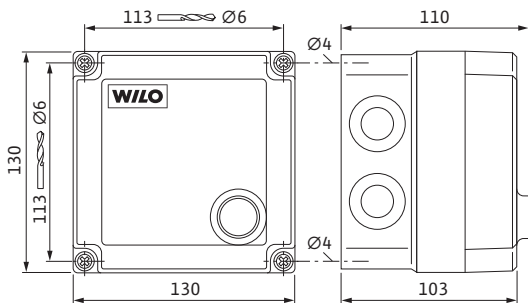

Fig.3b:

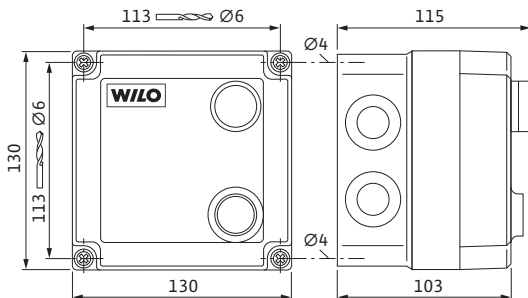

Fig.4: a.)

b.)

c.)

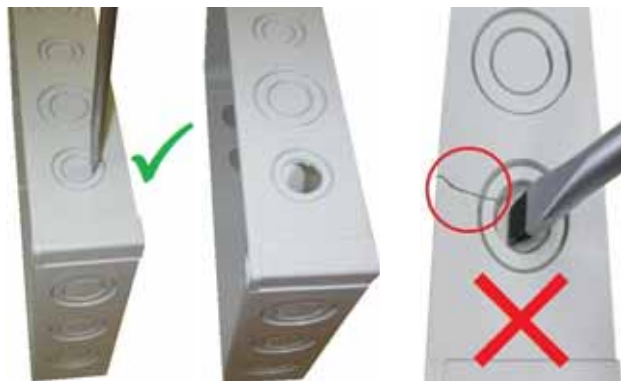

Fig.5:

⚡ 1~230 V
3~230/400 V

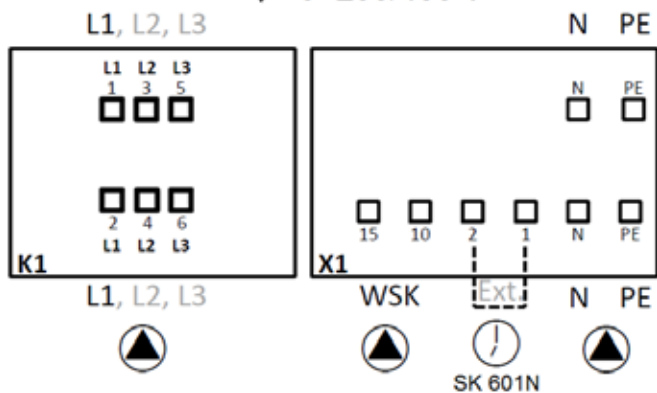
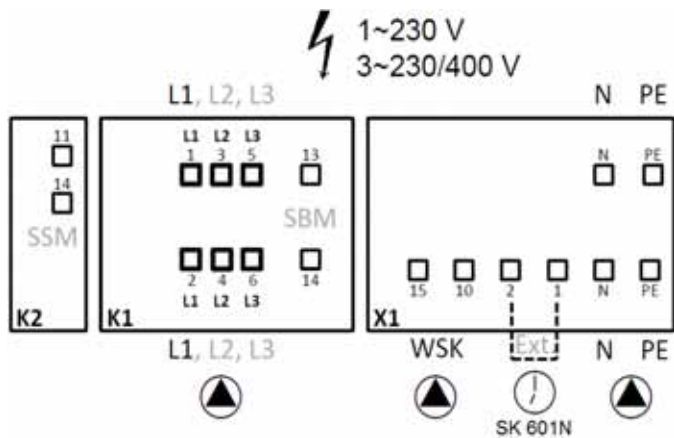

Fig.6:



1 General

About this document

The language of the original operating instructions is German. All other languages of these instructions are translations of the original operating instructions.

These installation and operating instructions are an integral part of the product. They must be kept readily available at the place where the product is installed. Strict adherence to these instructions is a precondition for the proper use and correct operation of the product.

The installation and operating instructions correspond to the relevant version of the product and the underlying safety regulations and standards valid at the time of going to print.

EC declaration of conformity:

A copy of the EC declaration of conformity is a component of these operating instructions.

If a technical modification is made on the designs named there without our agreement or the declarations made in the installation and operating instructions on product/personnel safety are not observed, this declaration loses its validity

2 Safety

These operating instructions contain basic information which must be adhered to during installation, operation and maintenance. For this reason, these operating instructions must, without fail, be read by the service technician and the responsible specialist/operator before installation and commissioning.

It is not only the general safety instructions listed under the main point "safety" that must be adhered to but also the special safety instructions with danger symbols included under the following main points.

2.1 Indication of instructions in the operating instructions

Symbols:



General danger symbol



Danger due to electrical voltage



NOTE

Signal words:

DANGER!

Acutely dangerous situation.

Non-observance results in death or the most serious of injuries.

WARNING!

The user can suffer (serious) injuries. 'Warning' implies that (serious) injury to persons is probable if this note is disregarded.

CAUTION!

There is a risk of damaging the product/unit. 'Caution' concerns possible damage to the product that could occur if this note is disregarded.

NOTE: Useful information on handling the product. It draws attention to possible problems.

Information that appears directly on the product, such as

- identification for connections
- rating plate
- warning sticker

must be strictly complied with and kept in legible condition.

2.2 Safety instructions for installation and maintenance work

The safety instructions included in these installation and operating instructions, the existing national regulations for accident prevention together with any internal working, operating and safety regulations of the operator are to be complied with.

The operator must ensure that all installation and maintenance work is carried out by authorised and qualified personnel, who are sufficiently informed due to their own detailed study of the installation and operating instructions.

Safety instructions of the installation and operating instructions for the pump are to be observed at all times when working on the switchgear and the pump/system!



DANGER! Danger of electric shock!

Work may only be carried out on the product/unit if they are switched off and secured against being switched on again. Immediately on conclusion of the work, all safety and protective devices must be put back in position and/or recommissioned.

2.3 Unauthorised modification and manufacture of spare parts

Unauthorised modification and manufacture of spare parts will impair the safety of the product/personnel and will make void the manufacturer's declarations regarding safety.

Modifications to the product are only permissible after consultation with the manufacturer. Original spare parts and accessories authorised by the manufacturer ensure safety. The use of other parts will absolve us of liability for consequential events.

3 Transport and interim storage

Immediately check the product for any transit damage on arrival. If damage is found, the necessary procedures involving the forwarding agent must be taken within the specified period.



CAUTION! Risk of damage to property!

Incorrect transport and interim storage can cause damage to the product.

- **The switchgear must be protected against moisture and mechanical damage caused by blows/impact.**
- **It must not be exposed to temperatures outside the range -10°C to $+40^{\circ}\text{C}$.**

4 Intended use

Wall-mounted unit for the electrical connection of single-phase and three-phase pumps with integrated thermal winding contacts (WSK) for monitoring the winding temperature (full motor protection). Automatic reactivation of pump after power failure and automatic fault acknowledgement after cooling off of the motor.



DANGER! Risk of fatal accident!

The switchgear is not protected against explosions and may not be operated in the explosive area.

Always install the switchgear outside the explosive area.

Intended use of the pump/installation also includes following these instructions.

Any other use is not regarded as intended use.

5 Product information

5.1 Type key

| | |
|-----------------|---------------|
| SK 602N/SK 622N | |
| SK | = switchbox |
| 602N/622N | = device type |

5.2 Technical data

| | |
|---------------------------------------|---|
| Operating voltage | 1~230 V (L, N, PE) 3~400 V (L1, L2, L3, N, PE) |
| Frequency | 50/60 Hz |
| Protection class | IP55 |
| Switching capacity AC-3 | 1~230 V, 1 kW 3~400 V, 3 kW 3~230 V, 1.5 kW |
| Power dissipation SK 602N | 1.93 W |
| Power dissipation SK 622N | 2.4 W |
| Switching capacity SSM (SK 622N only) | Max. 250 V/1 A/150 VA |
| Switching capacity SBM (SK 622N only) | Max. 250 V/1 A/150 VA |
| Temperature range | -10 °C to +40 °C |
| Housing | Polycarbonate/polyamide, RAL 7035 4x punch stampings for M20 |
| Housing dimensions (W x H x D) | 130 x 130 x 110 mm (SK 602N) 130 x 130 x 115 mm (SK 622N) |

5.3 Scope of delivery

- Switchbox, complete
- 4x M20 threaded cable connections
- Installation and operating instructions

5.4 Accessories

Accessories must be ordered separately:

- SK 601N
See the catalogue for a detailed list

6 Description and function

6.1 Switchbox description

SK 602N

Includes the contactor for full motor protection tripping, the On/Off switch, with integrated run signal light (Fig. 1, item 1), terminals for external potential-free activation/deactivation and terminal rail (Fig. 5).

SK 622N

Like SK 602N, but additionally with potential-free contacts for external run signal (SBM) and fault signal (SSM), see Fig. 6, as well as fault signal lights (Fig. 2, item 2).

Motor protection

The selection of the correct motor protection is a decisive factor for the service life and operational reliability of a circulation pump. Motor protection switches are no longer suitable for multi-speed pumps, since their motors have deviating rated currents in the different stages, which require different fuses. Motor fuse protection in Wilo pumps can be ensured by taking the following measures:

- **Blocking current-proof motors: No motor protection required.**

The pump motors are designed in such a way that current flowing through the winding cannot cause any damage in the event of overloading or blocking. This applies both to single-phase and three-phase versions, depending on the rated motor power.

- **Pumps with full motor protection and Wilo-SK 602/622N tripping unit or Wilo switchgear/control device**

Implementation of full motor protection by means of thermal winding contacts (WSK) within the motor winding. This applies both to single-phase and three-phase versions, depending on the rated motor power.

6.2 Switchbox function

The switchbox SK 602N/SK 622N switches the single phase or three phase power supply for the connected pump, depending on the WSK or the manual/external control, via a contactor (K1).

6.2.1 Switchgear operating elements

Pushbutton/latch switch (Fig. 1 and 2, item 1):

- OFF (not illuminated): No voltage is applied to the pump
- ON (illuminated in green): A voltage is applied to the pump

6.2.2 Display elements of the switchgear (for SK 622N only)

Red lamp (Fig. 2, item 2):

- OFF: Fault-free operation.
- ON: WSK error (thermal winding contact tripped)

7 Installation and electrical connection



DANGER! Risk of fatal accident!

Improper installation and electrical connection can result in fatal injury.

- **Installation and electrical connection may only be carried out by qualified personnel and in accordance with the applicable regulations.**
- **Adhere to regulations for accident prevention**

7.1 Installation

Install the switchgear in a dry, vibration-free and frost-proof location.

Protect the place of installation from direct sunlight.

To fasten the switchgear, open the upper part of the housing:

- Loosen the 4 cover fixing screws



CAUTION! Risk of damage to property!

Incorrect handling of the switchgear can result in property damage.

Do not drill through the housing into the wall!

- **The housing and electronic components might be damaged.**
- **Damage to the housing (cracks) can lead to leaks.**
- For wall-mounted installation, fasten the switchgear to the wall with dowels and screws. Dimensions for the drilling pattern in acc. with Fig. 3a and 3b, screw diameter 4 mm, bore diameter 6 mm.

Before mounting the switchgear, break out the required punch stampings on the side of the electric cable inlet and outlet for mounting the threaded cable connections.



WARNING! Risk of injury!

Improper work on the housing can cause injuries.

- **When opening the housing punch stampings, wear protective goggles, since housing parts can chip off.**
- **When opening the housing punch stampings, wear protective gloves to protect your hands from sharp edges.**

To open the punch stampings, use a slotted screwdriver with a 5.5 mm blade, a 300 g hammer as well as a deburrer.

To open the pre-punched holes, place the screwdriver blade perpendicular on the marked edge of the inner punch stamping (Fig. 4a) and punch the punch stamping out with a light hammer tap on the head of the screwdriver (Fig. 4b).

**CAUTION! Risk of damage to property!**

Improper work on the housing can result in property damage (Fig. 4c).

- **Damage to the housing (cracks) can lead to leaks.**
- **Burrs on the breakouts can impair the mounting of the threaded cable connections. To use safely, deburr the break-throughs.**

Use the threaded cable connections (M24) included in delivery as needed and fasten to the housing.

7.2 Electrical connection

**DANGER! Risk of fatal accident!**

A fatal shock may occur if the electrical connection is not made correctly.

- **Only allow the electrical connection to be made by an electrician approved by the local power supply company and in accordance with the local regulations in force.**
- **Observe the installation and operating instructions for the pumps and accessories.**
- **Disconnect the power supply before any work.**
- **Check to ensure that all connections (including potential-free contacts) are voltage-free.**

**CAUTION! Risk of damage to property!**

An incorrect electrical connection can cause damage to property.

- **If the wrong voltage is applied, the motor or switchgear can be damaged!**
- **Control via the triac/semiconductor relay is not possible.**

- The type of mains, current and voltage of the mains connection must match the details on the rating plate of the pump as well as the rating plate specifications and documentation of the switchgear.
- Provide fuse protection on the mains side (max. 10 A, slow-blow) as well as a residual-current-operated protection switch in accordance with the applicable regulations.
- To increase the operational reliability, we recommend the use of an automatic circuit breaker (which disconnects all power leads) with K characteristic.
- Feed the ends of the pump cable through the cable screw fittings and cable inlets and wire them according to the markings on the terminal strip (Fig. 5 or Fig. 6).
- The electrical connection must be established via a fixed power cable (3 x 1.5 mm², minimal cross-section), equipped with a plug and socket connector or an all-pole switch with a minimum contact opening width of 3 mm.
- To ensure drip protection and strain relief on the threaded cable connection, use cables with a sufficient outer diameter and screw the threaded cable connection tightly. In addition, the cables near the screwed connection are to be bent to form a drainage loop, to drain any accumulated drips.
- Earth the switchgear according to regulations.
- L1, (L2, L3), N, : Mains connection voltage: 3~400 V_{AC}/ 1~230 V_{AC}, 50/60 Hz, DIN IEC 60038, alternatively, the mains connection between the 2 phases of a three-phase network earthed at the star point is possible with a delta voltage of 3~230 V_{AC}, 50/60 Hz.

7.2.1 Single phase mains connection 1~230 V (L, N, PE)

Power supply connection:

- Terminals 1 (K1), N and PE (X1)
Connect phase L1 on the contactor (K1) to terminal 1 and N, PE on the terminal block (X1) according to the wiring diagram (Figs. 5 and 6).

Pump connection:

- Voltage: Terminals 2 (K1), N and PE (X1)
- WSK: Terminals 15, 10 (X1)
The pump is connected directly on the contactor (K1) to terminal 2 and N, PE on the terminal block (X1) according to the wiring diagram (Figs. 5 and 6).
Connect the WSK connection of the pump on the terminal block (X1) to terminals 10 and 15. If there is no WSK on the pump, a jumper must be connected between terminals 10 and 15 on the terminal block (X1).

7.2.2 Three-phase mains connection 3~400 V (L1, L2, L3, N, PE)

Power supply connection:

- Terminals 1, 3, 5 (K1), N and PE (X1)
Connect phases L1, L2, L3 on the contactor (K1) to the terminals 1, 3, 5 and N, PE on the terminal block (X1) according to the wiring diagram (Figs. 5 and 6).

Pump connection:

- Voltage: Terminals 2, 4, 6 (K1), N and PE (X1)
- WSK: Terminals 15, 10 (X1)
The pump is connected directly on the contactor (K1) to terminals 2, 4, 6 and N, PE on the terminal block (X1) according to the wiring diagram (Figs. 5 and 6).



NOTE: Incorrectly connecting the phases L1, L2, L3 can cause the pump to turn in the wrong direction of rotation. Observe the chapter “Rotation direction monitoring” in the installation and operating instructions of the respective pump.

Connect the WSK connection of the pump on the terminal block (X1) to terminals 10 and 15. If there is no WSK on the pump, a jumper must be connected between terminals 10 and 15 on the terminal block (X1).

7.2.3 Two-phase mains connection 3~230 V (L1, L2, PE)/ (L2, L3, PE)/(L3, L1, PE) for AC pumps, 230 V



CAUTION! Risk of damage to property!

An incorrect electrical connection can cause damage to property.

- **If the wrong voltage is applied, the motor or switchgear can be damaged!**
- **This connection to two phases is only permissible for these switchboxes and for AC pumps when the delta voltage in the supply system is 230 V.**

Power supply connection:

- Terminals 1 (K1), N and PE (X1)

When the delta voltage in the system is 230 V

Connect one of the phases L1/L2/L3 on the contactor (K1) to terminal 1 and another phase L1/L2/L3 to terminal N of the terminal block (X1) according to the wiring diagram. PE is connected to terminal PE of the terminal block (X1).

Pump connection:

- Voltage: Terminals 2 (K1), N and PE (X1)
- WSK: Terminals 15, 10 (X1)

The pump is connected directly on the contactor (K1) to terminal 2 and N, PE on the terminal block (X1) according to the wiring diagram (Figs. 5 and 6).

Connect the WSK connection of the pump on the terminal block (X1) to terminals 10 and 15. If there is no WSK on the pump, a jumper must be connected between terminals 10 and 15 on the terminal block (X1).

7.2.4 Signalling and indicator contacts



DANGER! Risk of fatal accident!

A fatal shock may occur if the electrical connection is not made correctly.

If the mains and SSM core are brought together in a 5-core cable, the SSM core must not be operated using a protective low voltage, since otherwise voltage transfers could occur.

For the switchbox SK 622N (Fig. 6), a collective fault signal "SSM" is available as a potential-free N/C contact for an external signal to the building automation and a collective run signal "SBM" is available as a potential-free contact.

SSM: Apply the collective fault signal at terminals 11 and 14 of relay K2 (Fig. 6).



NOTE: If there is integrated motor protection in the pump and the WSK terminals 10 and 15 on the terminal block X1 are bridged, the SSM signal is not available here.

SBM: Apply the collective run signal at terminals 13 and 14 of contactor K1 (Fig. 6).

7.2.5 External control

For the external control of the switchbox (e.g. with a time switch SK601N), the jumper at terminals 1 and 2 of the terminal block (X1) must be removed. The external switch contact is then to be connected to terminals 1 and 2. Alternatively to SK601N, an external switch can also be connected, with which the load switch (K1) is externally controlled for the pump.



NOTE: It is only possible to externally control the pump via SK 601N or a switch if the green push-button/latch switch is switched on SK 602N or SK 622N.

8 Commissioning



WARNING! Risk of injury and damage to property!
Incorrect commissioning can lead to injuries to persons and damage to property.

- **Commissioning by qualified personnel only!**
- **Observe the installation and operating instructions for the pumps and accessories.**
- **It is imperative that the warnings from chapter 7 be heeded!**
- **Before commissioning the switchgear and the pump, check whether these have been properly installed and connected.**

The pump is commissioned according to the corresponding pump documentation.

8.1 Operation

The pump is switched on/off manually by actuating the green push-button/latch switch on the front side of the switchgear SK 602N/SK 622N (Figs. 1 and 2, item 1) or via a potential-free contact/time switch. Operation is indicated by the green control lamp in the push-button/latch switch.



NOTE: It is only possible to externally control the pump via SK 601N or a switch if the green push-button/latch switch is switched on SK 602N or SK 622N.

When the power supply is restored after a mains failure, the motor is switched on again automatically.

For switchgear SK 622N, the motor protector is tripped by the red fault control lamp (Fig. 2, item 2). The motor stays off until

it has cooled off. The automatic fault acknowledgement of the pump happens after the motor cools off.



NOTE: During the initial commissioning of the switchbox SK622N, the red lamp lights up briefly.

When the motor protection trips repeatedly, the motor must be checked electrically and mechanically. If necessary, Wilo customer service should be notified.

Faults, causes and remedies

| Faults | Causes | Remedy |
|--|---|---|
| Pump is not running although the power supply is switched on. (In the case of SK 622N, the red lamp is not illuminated) | Green pressure switch on the SK 602N/SK 622N is switched off | Switch on the green pressure switch (Figs. 1 and 2, item 1) |
| | External control (e.g. SK 601N) is connected, but switched off | Switch on external control (e.g. SK 601N) |
| | No jumper between terminals 1 and 2 on the terminal block X1 | Place a jumper between terminals 1 and 2 on the terminal block X1 |
| Pump is not running although the power supply is switched on. (In the case of SK 622N, the red lamp is illuminated) | WSK contact of the pump not connected to terminals 10 and 15 | Connect WSK to terminals 10 and 15 |
| | WSK of the pump was tripped or is defective | After the motor cools off, the pump starts up on its own. |
| | For pumps without a WSK, contacts 15 and 10 on the terminal block X1 are not bridged. | Bridge contacts 15 and 10 on the terminal block X1. |

If the operating fault cannot be remedied, please contact a specialist technician or the nearest Wilo customer service location or representative.

9 Spare parts

Spare parts are ordered via local specialist retailers and/or Wilo customer service.

In order to avoid further inquiries and incorrect orders, all data on the rating plate should be specified for each order.

10 Disposal

Damage to the environment and risks to personal health are avoided by properly disposing of and recycling this product.

1. Use public or private disposal organisations when disposing of the entire product or part of the product.
2. For more information on proper disposal, please contact your local council or waste disposal office or the supplier from whom you obtained the product.



NOTE: The switchgear must not be disposed of with household waste.

Subject to change without prior notice!

D EG – Konformitätserklärung
GB EC – Declaration of conformity
F Déclaration de conformité CE

*(gemäß 2004/108/EG Anhang IV.2 und 2006/95/EG Anhang III.B,
according 2004/108/EC annex IV.2 and 2006/95/EC annex III.B,
conforme 2004/108/CE appendice IV.2 et 2006/95/CE appendice III B)*

Hiermit erklären wir, dass die Bauarten der Baureihe :
Herewith, we declare that this product:
Par le présent, nous déclarons que cet produit :

SK 602N
SK 622N

in der gelieferten Ausführung folgenden einschlägigen Bestimmungen entspricht:
in its delivered state complies with the following relevant provisions:
est conforme aux dispositions suivants dont il relève:

Elektromagnetische Verträglichkeit – Richtlinie
Electromagnetic compatibility – directive
Compatibilité électromagnétique – directive

2004/108/EG

Niederspannungsrichtlinie
Low voltage directive
Directive basse-tension

2006/95/EG

und entsprechender nationaler Gesetzgebung.
and with the relevant national legislation.
et aux législations nationales les transposant.

Angewendete harmonisierte Normen, insbesondere:
Applied harmonized standards, in particular:
Normes harmonisées, notamment:

EN 60204-1
EN 60439-1+A1
EN 60439-3+A+A2
EN 62208
EN 60439-1 : 2005

Bei einer mit uns nicht abgestimmten technischen Änderung der oben genannten Bauarten, verliert diese Erklärung ihre Gültigkeit.
If the above mentioned series are technically modified without our approval, this declaration shall no longer be applicable.
Si les gammes mentionnées ci-dessus sont modifiées sans notre approbation, cette déclaration perdra sa validité.

Dortmund, 06.08.2012

Holger Herchenhein
Quality Manager



WILO SE
Nortkirchenstraße 100
44263 Dortmund
Germany

| | |
|---|---|
| <p>NL EG-verklaring van overeenstemming Hiermede verklaren wij dat dit aggregaat in de geleverde uitvoering voldoet aan de volgende bepalingen: Elektromagnetische compatibiliteit 2004/108/EG EG-laagspanningsrichtlijn 2006/95/EG gebruikte geharmoniseerde normen, in het bijzonder: zie vorige pagina</p> | <p>I Dichiarazione di conformità CE Con la presente si dichiara che i presenti prodotti sono conformi alle seguenti disposizioni e direttive rilevanti: Compatibilità elettromagnetica 2004/108/EG Direttiva bassa tensione 2006/95/EG norme armonizzate applicate, in particolare: vedi pagina precedente</p> |
| <p>E Declaración de conformidad CE Por la presente declaramos la conformidad del producto en su estado de suministro con las disposiciones pertinentes siguientes: Directiva sobre compatibilidad electromagnética 2004/108/EG Directiva sobre equipos de baja tensión 2006/95/EG normas armonizadas adoptadas, especialmente: véase página anterior</p> | <p>P Declaração de Conformidade CE Pela presente, declaramos que esta unidade no seu estado original, está conforme os seguintes requisitos: Compatibilidade electromagnética 2004/108/EG Directiva de baixa voltagem 2006/95/EG normas harmonizadas aplicadas, especialmente: ver página anterior</p> |
| <p>S CE- försäkran Härmed förklarar vi att denna maskin i levererat utförande motsvarar följande tillämpliga bestämmelser: EG–Elektromagnetisk kompatibilitet – riktlinje 2004/108/EG EG–Lågspänningsdirektiv 2006/95/EG tillämpade harmoniserade normer, i synnerhet: se föregående sida</p> | <p>N EU-Overensstemmelseserklæring Vi erklærer hermed at denne enheten i utførelse som levert er i overensstemmelse med følgende relevante bestemmelser: EG–EMV–Elektromagnetisk kompatibilitet 2004/108/EG EG–Lavspenningsdirektiv 2006/95/EG anvendte harmoniserte standarder, særlig: se forrige side</p> |
| <p>FIN CE-standardinmakuisseloste Ilmoitamme täten, että tämä laite vastaa seuraavia asiaankuuluvia määräyksiä: Sähkömagneettinen soveltuvuus 2004/108/EG Matalajännite direktiivi: 2006/95/EG käytetyt yhteensovitetut standardit, erityisesti: katso edellinen sivu.</p> | <p>DK EF-overensstemmelseserklæring Vi erklærer hermed, at denne enhed ved levering overholder følgende relevante bestemmelser: Elektromagnetisk kompatibilitet: 2004/108/EG Lavvolts-direktiv 2006/95/EG anvendte harmoniserede standarder, særligt: se forrige side</p> |
| <p>H EK-megfelelősségi nyilatkozat Ezennel kijelentjük, hogy az berendezés megfelel az alábbi irányelveknek: Elektromágneses összeférhetőség irányelv: 2004/108/EK Kisfeszültségű berendezések irányelv: 2006/95/EK alkalmazott harmonizált szabványoknak, különösen: lásd az előző oldalt</p> | <p>CZ Prohlášení o shodě ES Prohlašujeme tímto, že tento agregát v dodaném provedení odpovídá následujícím příslušným ustanovením: Směrnice o elektromagnetické kompatibilitě 2004/108/ES Směrnice pro nízké napětí 2006/95/ES použité harmonizační normy, zejména: viz předchozí strana</p> |
| <p>PL Deklaracja Zgodności WE Niniejszym deklarujemy z pełną odpowiedzialnością, że dostarczony wyrób jest zgodny z następującymi dokumentami: dyrektywą dot. kompatybilności elektromagnetycznej 2004/108/WE dyrektywą niskonapięciową 2006/95/WE stosowanymi normami zharmonizowanymi, a w szczególności: patrz poprzednia strona</p> | <p>RUS Декларация о соответствии Европейским нормам Настоящим документом заявляем, что данный агрегат в его объеме поставки соответствует следующим нормативным документам: Электромагнитная устойчивость 2004/108/EG Директивы по низковольтному напряжению 2006/95/EG Используемые согласованные стандарты и нормы, в частности: см. предыдущую страницу</p> |

| | |
|--|--|
| <p>GR Δήλωση συμμόρφωσης της ΕΕ Δηλώνουμε ότι το προϊόν αυτό σ' αυτή την κατάσταση παράδοσης ικανοποιεί τις ακόλουθες διατάξεις: Ηλεκτρομαγνητική συμβατότητα ΕΚ-2004/108/ΕΚ Οδηγία χαμηλής τάσης ΕΚ-2006/95/ΕΚ Εναρμονισμένα χρησιμοποιούμενα πρότυπα, ιδιαίτερα: Βλέπε προηγούμενη σελίδα</p> | <p>TR CE Uygunluk Teyid Belgesi Bu cihazın teslim edilmiş şekliyle aşağıdaki standartlara uygun olduğunu teyid ederiz: Elektromanyetik Uyumluluk 2004/108/EG Alçak gerilim yönetmeliği 2006/95/EG kismen kullanılan standartlar için: bkz. bir önceki sayfa</p> |
| <p>RO EC-Declarație de conformitate Prin prezenta declarăm că acest produs așa cum este livrat, corespunde cu următoarele prevederi aplicabile: Compatibilitatea electromagnetică – directiva 2004/108/EG Directiva privind tensiunea joasă 2006/95/EG standarde armonizate aplicate, îndeosebi: vezi pagina precedentă</p> | <p>EST EÜ vastavusdeklaratsioon Käesolevaga tõendame, et see toode vastab järgmistele asjakohastele direktiividele: Elektromagnetilise ühilduvuse direktiiv 2004/108/EÜ Madalpinge direktiiv 2006/95/EÜ kohaldatud harmoneeritud standardid, eriti: vt eelmist lk</p> |
| <p>LV EC - atbilstības deklarācija Ar šo mēs apliecinām, ka šis izstrādājums atbilst sekojošiem noteikumiem: Elektromagnētiskās savietojamības direktīva 2004/108/EK Zemsprieguma direktīva 2006/95/EK piemēroti harmonizēti standarti, tai skaitā: skatīt iepriekšējo lappusi</p> | <p>LT EB atitikties deklaracija Šiuo pažymima, kad šis gaminyas atitinka šias normas ir direktyvas: Elektromagnetinio suderinamumo direktyvą 2004/108/EB Žemos įtampos direktyvą 2006/95/EB pritaikytus vieningus standartus, o būtent: žr. ankstesniame puslapyje</p> |
| <p>SK ES vyhlásenie o zhode Týmto vyhlasujeme, že konštrukcie tejto konštrukčnej série v dodanom vyhotovení vyhovujú nasledujúcim príslušným ustanoveniam: Elektromagnetická zhoda - smernica 2004/108/ES Nízkonapäťové zariadenia - smernica 2006/95/ES používané harmonizované normy, najmä: pozri predchádzajúcu stranu</p> | <p>SLO ES – izjava o skladnosti Izjavljamo, da dobavljene vrste izvedbe te serije ustrezajo sledečim zadevnim določilom: Direktiva o elektromagnetni združljivosti 2004/108/ES Direktiva o nizki napetosti 2006/95/ES uporabljeni harmonizirani standardi, predvsem: glejte prejšnjo stran</p> |
| <p>BG EO-Декларация за съответствие Декларираме, че продуктът отговаря на следните изисквания: Електромагнитна съвместимост – директива 2004/108/EO Директива ниско напрежение 2006/95/EO Хармонизирани стандарти: вж. предната страница</p> | <p>M Dikjarazzjoni ta' konformità KE B'dan il-mezz, niddikjaraw li l-prodotti tas-serje jissodisfaw id-dispożizzjonijiet relevanti li ġejjin: Kompatibbiltà elettromanjetika - Direttiva 2004/108/KE Vultaġġ baxx - Direttiva 2006/95/KE kif ukoll standards armonizzati b' mod partikolari: ara l-paġna ta' qabel</p> |



WILO SE
 Nortkirchenstraße 100
 44263 Dortmund
 Germany

Wilo – International (Subsidiaries)

Argentina

WILO SALMSON
Argentina S.A.
C1295ABI Ciudad Autónoma
de Buenos Aires
T+ 54 11 4361 5929
info@salmson.com.ar

Australia

WILO Australia Pty Limited
Murrarie, Queensland, 4172
T +61 7 3907 6900
chris.dayton@wilo.com.au

Austria

WILO Pumpen
Österreich GmbH
2351 Wiener Neudorf
T +43 507 507-0
office@wilo.at

Azerbaijan

WILO Caspian LLC
1014 Baku
T +994 12 5962372
info@wilo.az

Belarus

WILO Bel OOO
220035 Minsk
T +375 17 2535363
wilo@wilo.by

Belgium

WILO SA/NV
1083 Ganshoren
T +32 2 4823333
info@wilo.be

Bulgaria

WILO Bulgaria Ltd.
1125 Sofia
T +359 2 9701970
info@wilo.bg

Brazil

WILO Brasil Ltda
Jundiaí – SP – CEP
13.201-005
T + 55 11 2817 0349
wilo@wilo-brasil.com.br

Canada

WILO Canada Inc.
Calgary, Alberta T2A 5L4
T +1 403 2769456
bill.lowew@wilo-na.com

China

WILO China Ltd.
101300 Beijing
T +86 10 58041888
wiloobj@wilo.com.cn

Croatia

WILO Hrvatska d.o.o.
10090 Zagreb
T +38 51 3430914
wilo-hrvatska@wilo.hr

Czech Republic

WILO Praha s.r.o.
25101 Cestlice
T +420 234 098711
info@wilo.cz

Denmark

WILO Danmark A/S
2690 Karlslunde
T +45 70 253312
wilo@wilo.dk

Estonia

WILO Eesti OÜ
12618 Tallinn
T +372 6 5093780
info@wilo.ee

Finland

WILO Finland OY
02330 Espoo
T +358 207401540
wilo@wilo.fi

France

WILO S.A.S.
78390 Bois d'Arcy
T +33 1 30050930
info@wilo.fr

Great Britain

WILO (U.K.) Ltd.
DE14 2WJ Burton-
Upon-Trent
T +44 1283 523000
sales@wilo.co.uk

Greece

WILO Hellas AG
14569 Anixi (Attika)
T +302 10 6248300
wilo@wilo.gr

Hungary

WILO Magyarország Kft
2045 Törökbálint
(Budapest)
T +36 23 889500
wilo@wilo.hu

India

WILO India Mather and
Platt Pumps Ltd.
Pune 411019
T +91 20 27442100
service@
pun.matherplatt.co.in

Indonesia

WILO Pumps Indonesia
Jakarta Selatan 12140
T +62 21 7247676
citrawilo@cbn.net.id

Ireland

WILO Ireland
Limerick
T +353 61 227566
sales@wilo.ie

Italy

WILO Italia s.r.l.
20068 Peschiera Borromeo
(Milano)
T +39 25538351
wilo.italia@wilo.it

Kazakhstan

WILO Central Asia
050002 Almaty
T +7 727 2785961
info@wilo.kz

Korea

WILO Pumps Ltd.
621-807 Gimhae
Gyeongnam
T +82 55 3405890
wilo@wilo.co.kr

Latvia

WILO Baltic SIA
1019 Riga
T +371 7 145229
mail@wilo.lv

Lebanon

WILO SALMSON
Lebanon
12022030 El Metn
T +961 4 722280
wsl@cyberia.net.lb

Lithuania

WILO Lietuva UAB
03202 Vilnius
T +370 5 2136495
mail@wilo.lt

Morocco

WILO Maroc
SARLQUARTIER
INDUSTRIEL AIN SEBAA
20250
CASABLANCA
T +212 (0) 5 22 660 924
contact@wilo.ma

The Netherlands

WILO Nederland b.v.
1551 NA Westzaan
T +31 88 9456 000
info@wilo.nl

Norway

WILO Norge AS
0975 Oslo
T +47 22 804570
wilo@wilo.no

Poland

WILO Polska Sp. z o.o.
05-090 Raszyn
T +48 22 7026161
wilo@wilo.pl

Portugal

Bombas Wilo-Salmson
Portugal Lda.
4050-040 Porto
T +351 22 2080350
bombas@wilo.pt

Romania

WILO Romania s.r.l.
077040 Com. Chiajna Jud.
Ilfov
T +40 21 3170164
wilo@wilo.ro

Russia

WILO Rus ooo
123592 Moscow
T +7 495 7810690
wilo@wilo.ru

Saudi Arabia

WILO ME - Riyadh
Riyadh 11465
T +966 1 4624430
wshoula@wataniaind.com

Serbia and Montenegro

WILO Beograd d.o.o.
11000 Beograd
T +381 11 2851278
office@wilo.co.yu

Slovakia

WILO Slovakia s.r.o.
83106 Bratislava
T +421 2 33014511
wilo@wilo.sk

Slovenia

WILO Adriatic d.o.o.
1000 Ljubljana
T +386 1 5838130
wilo.adriatic@wilo.si

South Africa

Salmson South Africa
1610 Edenvale
T +27 11 6082780
errol.cornelius@
salmson.co.za

Spain

WILO Ibérica S.A.
28806 Alcalá de Henares
(Madrid)
T +34 91 8797100
wilo.iberica@wilo.es

Sweden

WILO Sverige AB
35246 Växjö
T +46 470 727600
wilo@wilo.se

Switzerland

EMB Pumpen AG
4310 Rheinfelden
T +41 61 83680-20
info@emb-pumpen.ch

Taiwan

WILO-EMU Taiwan Co. Ltd.
110 Taipei
T +886 227 391655
nelson.wu@
wiloemutaiwan.com.tw

Turkey

WILO Pompa Sistemleri
San. ve Tic. A.Ş.
34956 İstanbul
T +90 216 2509400
wilo@wilo.com.tr

Ukraine

WILO Ukraina t.o.w.
01033 Kiev
T +38 044 2011870
wilo@wilo.ua

United Arab Emirates

WILO Middle East FZE
Jebel Ali Free Zone - South -
Dubai
T +971 4 880 91 77
info@wilo.ae

USA

WILO USA LLC
Rosemont, IL 60018
T +1 866 945 6872
info@wilo-usa.com

Vietnam

WILO Vietnam Co Ltd.
Ho Chi Minh City, Vietnam
T +84 8 38109975
nkminh@wilo.vn



WILO SE
Nortkirchenstraße 100
44263 Dortmund
Germany
T 0231 4102-0
F 0231 4102-7363
wilo@wilo.com
www.wilo.de

Wilo-Vertriebsbüros in Deutschland

Nord

WILO SE
Vertriebsbüro Hamburg
Beim Strohhouse 27
20097 Hamburg
T 040 5559490
F 040 5559494
hamburg.anfragen@wilo.com

Ost

WILO SE
Vertriebsbüro Dresden
Frankenring 8
01723 Kesselsdorf
T 035204 7050
F 035204 70570
dresden.anfragen@wilo.com

Süd-West

WILO SE
Vertriebsbüro Stuttgart
Hertichstraße 10
71229 Leonberg
T 07152 94710
F 07152 947141
stuttgart.anfragen@wilo.com

West I

WILO SE
Vertriebsbüro Düsseldorf
Westring 19
40721 Hilden
T 02103 90920
F 02103 909215
duesseldorf.anfragen@wilo.com

Nord-Ost

WILO SE
Vertriebsbüro Berlin
Juliusstraße 52-53
12051 Berlin-Neukölln
T 030 6289370
F 030 62893770
berlin.anfragen@wilo.com

Süd-Ost

WILO SE
Vertriebsbüro München
Adams-Lehmann-Straße 44
80797 München
T 089 4200090
F 089 42000944
muenchen.anfragen@wilo.com

Mitte

WILO SE
Vertriebsbüro Frankfurt
An den drei Hasen 31
61440 Oberursel/Ts.
T 06171 70460
F 06171 704665
frankfurt.anfragen@wilo.com

West II

WILO SE
Vertriebsbüro Dortmund
Nortkirchenstr. 100
44263 Dortmund
T 0231 4102-6560
F 0231 4102-6565
dortmund.anfragen@wilo.com

Kompetenz-Team Gebäudetechnik

WILO SE
Nortkirchenstraße 100
44263 Dortmund
T 0231 4102-7516
F 0231 4102-7666

Erreichbar Mo-Do 7-18 Uhr, Fr 7-17 Uhr.

- Antworten auf
 - Produkt- und Anwendungsfragen
 - Liefertermine und Lieferzeiten
- Informationen über Ansprechpartner vor Ort
- Versand von Informationsunterlagen

Standorte weiterer Tochtergesellschaften

Die Kontaktdaten finden
Sie unter www.wilo.com.

- * 0,14 €/Min. aus dem Festnetz,
Mobilfunk max. 0,42 €/Min.

Kompetenz-Team Kommune Bau + Bergbau

WILO SE, Werk Hof
Heimgartenstraße 1-3
95030 Hof
T 09281 974-550
F 09281 974-551

Werkskundendienst Gebäudetechnik Kommune Bau + Bergbau Industrie

WILO SE
Nortkirchenstraße 100
44263 Dortmund
T 0231 4102-7900
T 01805 W-I-L-O-K-D*
9-4-5-6-5-3
F 0231 4102-7126
kundendienst@wilo.com

Täglich 7-18 Uhr
erreichbar
24 Stunden Technische
Notfallunterstützung

- Kundendienst-
Anforderung
- Werksreparaturen
- Ersatzteillfragen
- Inbetriebnahme
- Inspektion
- Technische
Service-Beratung
- Qualitätsanalyse

Wilo-International

Österreich

Zentrale Wiener
Neudorf:
WILO Pumpen Österreich
GmbH
Wilo Straße 1
A-2351 Wiener Neudorf
T +43 507 507-0
F +43 507 507-15
office@wilo.at
www.wilo.at

Vertriebsbüro Salzburg:
Gnigler Straße 56
A-5020 Salzburg
T +43 507 507-13
F +43 662 878470
office.salzburg@wilo.at
www.wilo.at

Vertriebsbüro
Oberösterreich:
Trattnachtalstraße 7
A-4710 Grieskirchen
T +43 507 507-26
F +43 7248 65054
office.oberoester-
reich@wilo.at
www.wilo.at

Schweiz

EMB Pumpen AG
Gerstenweg 7
CH-4310 Rheinfelden
T +41 61 83680-20
F +41 61 83680-21
info@emb-pumpen.ch
www.emb-pumpen.ch

Stand August 2012