

Pioneering for You

wilo

Recirculation pump

Flumen OPTI-RZP 80-3.28-4/30

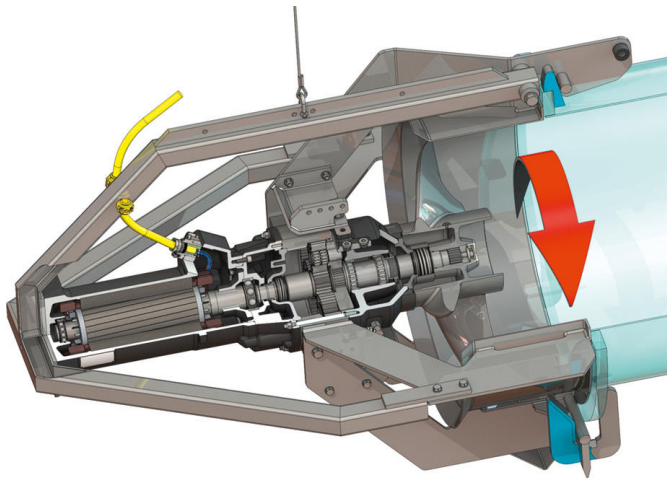

Unit

Max. weight* <i>m</i>	500 kg
Explosion protection ATEX	optional
Explosion protection FM	optional
Protection class motor	IP68

Propeller

Propeller model	3-blade propeller with self-cleaning hub; clogging- and entwining-free
Nominal propeller diameter <i>D_{nom}</i>	800 mm
Propeller speed <i>n</i>	280 1/min
Transmission ratio	5.286

Filling quantities and types

Filling prechamber	Gear oil CLP220
Filling volume prechamber <i>V</i>	2.00 l
Filling gear chamber	Gear oil CLP220
Fill volume gear chamber <i>V</i>	1.10 l
Filling sealing chamber	White oil
Fill volume sealing chamber <i>V</i>	2.00 l

Motor/electronics

Motor type	T 20-4/30R (Ex)
Motor design	Submersible motor – surface-cooled
Mains connection	3~400 V, 50 Hz
Rated current <i>I_N</i>	36.50 A
Starting current – direct <i>I_A</i>	220.00 A
Starting current – star-delta <i>I_A</i>	73.00 A
Power consumption <i>P_{2,max}</i>	22.00 kW
Rated power <i>P₂</i>	18.5 kW
Speed original <i>n</i>	1435 1/min
Motor efficiency class	–
Efficiency η_M	86.0 %
Power factor $\cos \varphi_{100}$	0.86
Min. fluid temperature <i>T_{min}</i>	3 °C
Max. fluid temperature <i>T_{max}</i>	40 °C
Max. immersion depth	20 m
Insulation class	H
Max. switching frequency <i>t</i>	15 rph
min. switching break <i>t</i>	3 min
Starting torque <i>M</i>	235 Nm
Moment of inertia	0.0598 kg/m ²
Motor bearings	1 grooved ball bearing, 1 two-row inclined ball bearing

Materials

Motor housing	5.1301, EN-GJL-250
Static gaskets	FKM
Motor shaft	1.4021, X20Cr13
Seal, gear/sealing chamber	SiC/SiC, Q1Q1VGG
Gear housing	5.1301, EN-GJL-250
Planetary gear	1.7131, 16MnCr5
Hollow gear	1.5216, 17MnV6
Sun gear	1.7131, 16MnCr5
Output shaft	1.4462, X2CrNiMoN22-5-3
Seal, gear chamber/prechamber	FKM
Sealing chamber	5.1301, EN-GJL-250
Seal on the fluid side	SiC/SiC, Q1Q1VGG
Seal bushing	1.4571, X6CrNiMoTi17-12-2
Propeller	1.4408, GX5CrNiMo19-11-2
Flow housing	1.4571, X6CrNiMoTi17-12-2

Gear

Gear construction type	m 3.0 as per DIN 780-1:1977-05 /P10 (ISO54:1996-12); sun and planetary gears case hardened and sanded, internal gear butt-jointed
Gear bearings	3x2 needle roller bearing (planetary), two roller bearings (output shaft)
Service life <i>L_{h20}</i>	100,000 operating hours, ISO 281:2007-02

*maximum weight including accessories

Subject to change without prior notice.