

Zubehör - Accessories - Accessoires

Wilo Flumen OPTI RZP 80-3

AVR 100 - AVRD 100 - AVRZ 100 - AVRZD 100

**wilo**

Heimgartenstraße 1-3 D-95030 Hof/Saale  
 Telefon +49 9281 974-0 Fax +49 9281 96528  
 www.wilo.com E-Mail: info@wilo.com

Kunde  
 Customer  
 Client

Projekt  
 Project  
 Projet

Angebot - Quotation - Offre

Auftrag - Order - Commande

Nr. - No.:

Auftragsbezogene Maße X =  mm  
 Dimensions acc. to order L =  mm  
 Dimensions selon commande

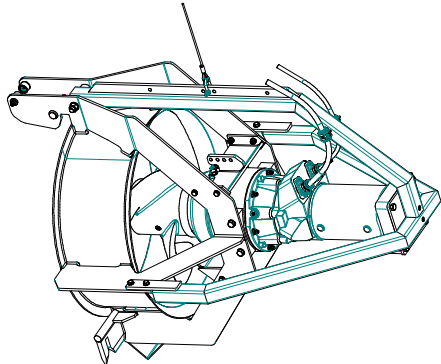

RZP 80-3

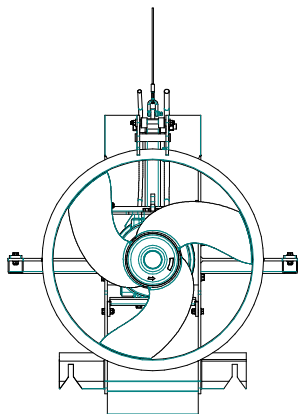

RZP 80-3. - /

KMAT 6090054

AVR 100

KMAT  
 6000555

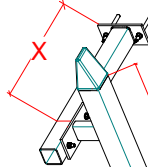
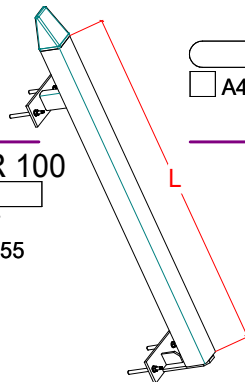

AVRD 100

KMAT  
 6000555

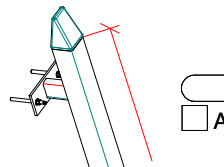
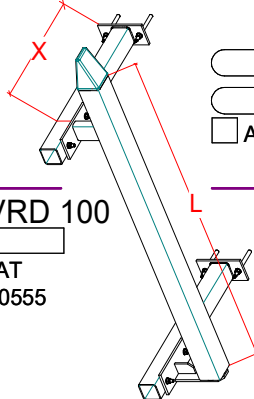

AVRZ 100

KMAT  
 6000555

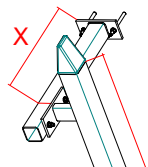
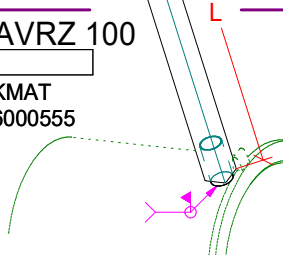

AVRZD 100

KMAT  
 6000555

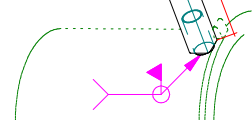

6011006

A4

6011006

6010965

A4

6011005

A4

6011005

6010964

A4

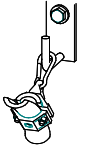

6010947 Ø10-17  
 6010946 Ø17-25  
 6011029 Ø26-36

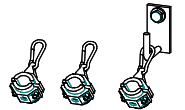

6010940 Ø10-17  
 6010939 Ø17-25  
 6010948 Ø26-35



E4 6049242

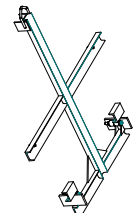

6045513

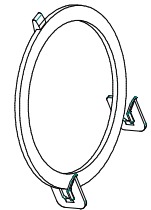

6044846

A4 = 1.4571 / AISI 316Ti / Z 6 CNDT 17-12

= Befestigungssatz / fixing elements / éléments de fixation