

Zubehör - Accessories - Accessoires

Wilo Flumen OPTI RZP 60-4  
AVR 80 - AVRZ 80 - AVRZD 80



Heimgartenstraße 1-3 D-95030 Hof/Saale  
Telefon +49 9281 974-0 Fax +49 9281 96528  
www.wilo.com E-Mail: info@wilo.com

Kunde  
Customer  
Client

Projekt  
Project  
Projet

Angebot - Quotation - Offre  
Auftrag - Order - Commande  
Nr. - No.:

Auftragsbezogene Maße X =  mm  
Dimensions acc. to order L =  mm  
Dimensions selon commande

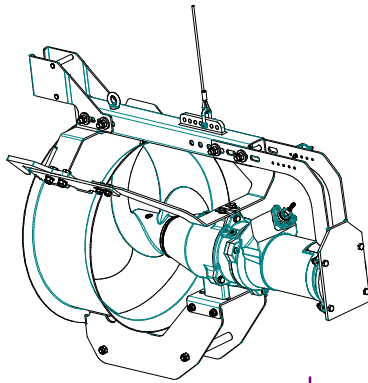

RZP 60-4

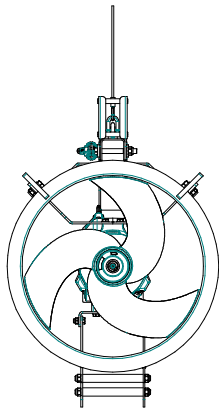

RZP 60-4. \_ - / \_  
KMAT 6091010

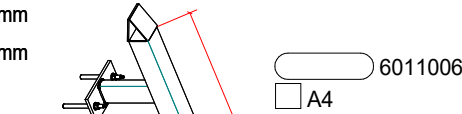
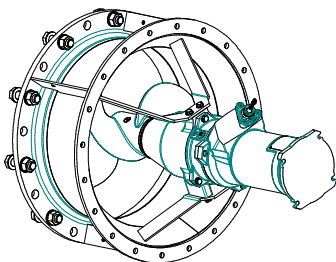

AVR 80

KMAT  
6000555

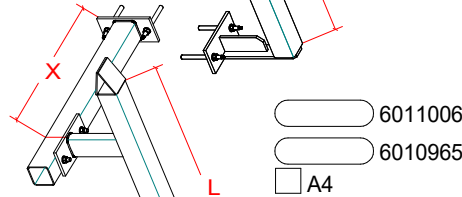

AVRD 80

KMAT  
6000555

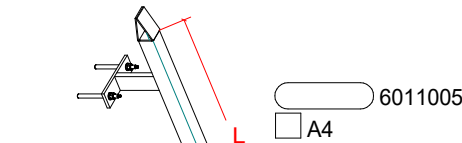

AVRZ 80

KMAT  
6000555

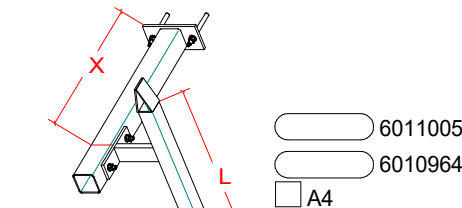

AVRZD 80

KMAT  
6000555

- 6010947 Ø10-17
- 6010946 Ø17-25
- 6011029 Ø26-36

- 6010940 Ø10-17
- 6010939 Ø17-25
- 6010948 Ø26-36

6083410

A4 6060982

A4 = 1.4571 / AISI 316Ti / Z 6 CNDT 17-12

= Befestigungssatz / fixing elements / éléments de fixation