

Zubehör - Accessories - Accessoires

Wilo Flumen OPTI RZP 50-4
AVR 80 - AVRD 80 - AVRZ 80 - AVRZD 80



Heimgartenstraße 1-3 D-95030 Hof/Saale
Telefon +49 9281 974-0 Fax +49 9281 96528
www.wilo.com E-Mail: info@wilo.com

Kunde
Customer
Client

Projekt
Project
Projet

Angebot - Quotation - Offre
Auftrag - Order - Commande
Nr. - No.:

Auftragsbezogene Maße X = mm
Dimensions acc. to order L = mm
Dimensions selon commande

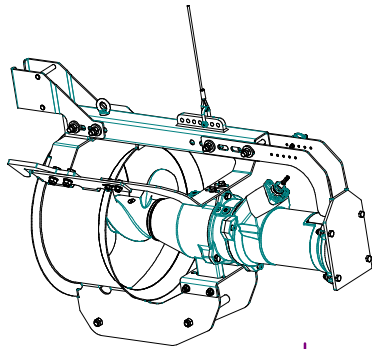

RZP 50-4

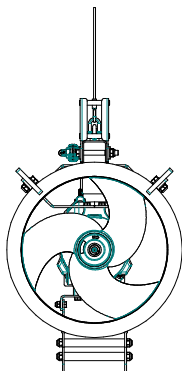

RZP 50-4. _ - _ / _
KMAT 6091009

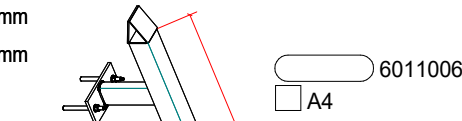
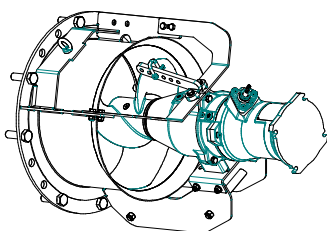

AVR 80

KMAT
6000555

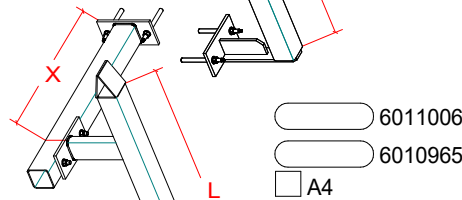

AVRD 80

KMAT
6000555

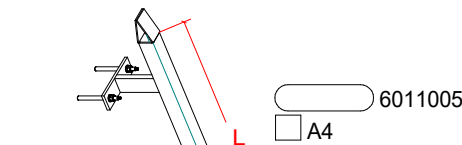

AVRZ 80

KMAT
6000555

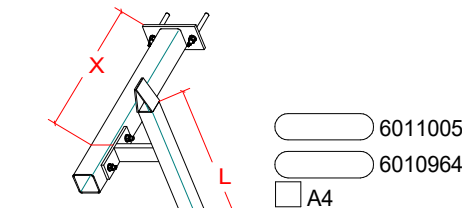

AVRZD 80

KMAT
6000555

- 6010947 Ø10-17
- 6010946 Ø17-25
- 6011029 Ø26-36

- 6010940 Ø10-17
- 6010939 Ø17-25
- 6010948 Ø26-36

6083410

A4 6060983

A4 = 1.4571 / AISI 316Ti / Z 6 CNDT 17-12

= Befestigungssatz / fixing elements / éléments de fixation