

Pioneering for You

Submersible mixer

Flumen OPTI-TR 80-3.24-6/32

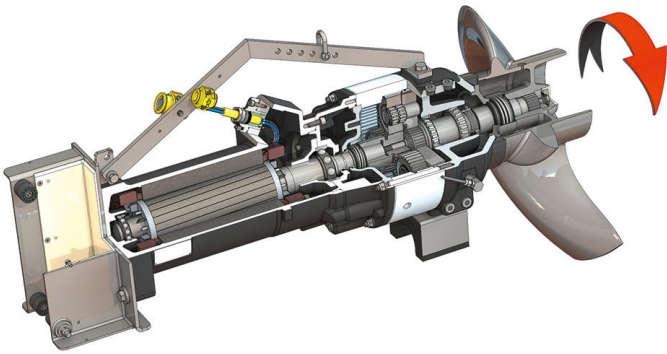

Unit

Power consumption at duty point $P_{1,1}$	8.10 kW
Max. thrust F	2300 N
Thrust to power ratio	284 N/kW
Max. weight* m	360 kg
Explosion protection ATEX ATEX	optional
Explosion protection FM FM	optional
Protection class motor	IP68

Propeller

Propeller model	3-blade propeller with self-cleaning hub; clogging- and entwining-free
Nominal propeller diameter D_{nom}	800 mm
Propeller speed n	245 1/min
Transmission ratio	4.000

Filling quantities and types

Filling prechamber	Gear oil CLP220
Filling volume prechamber V	2.00 l
Filling gear chamber	Gear oil CLP220
Fill volume gear chamber V	1.10 l
Filling sealing chamber	White oil
Fill volume sealing chamber V	2.00 l

Motor/electronics

Motor type	T 20-6/32R (Ex)
Motor design	Submersible motor – surface-cooled
Mains connection	3~400 V, 50 Hz
Rated current I_N	26.00 A
Starting current – direct I_A	140.00 A
Starting current – star-delta I_A	47.00 A
Power consumption $P_{1 max}$	14.90 kW
Rated power P_2	12.5 kW
Speed original n	930 1/min
Motor efficiency class	–
Efficiency η_M	84.0 %
Power factor $\cos \varphi$	0.84
Min. fluid temperature T_{min}	3 °C
Max. fluid temperature T_{max}	40 °C
Max. immersion depth	20 m
Insulation class	H
Max. switching frequency t	15 rph
min. switching break t	3 min
Starting torque M	246 Nm
Moment of inertia	0.0778 kg/m ²
Motor bearings	1 grooved ball bearing, 1 two-row inclined ball bearing

Materials

Motor housing	5.1301, EN-GJL-250
Static gaskets	FKM
Motor shaft	1.4021, X20Cr13
Seal, gear/sealing chamber	SiC/SiC, Q1Q1VGG
Gear housing	5.1301, EN-GJL-250
Planetary gear	1.7131, 16MnCr5
Hollow gear	1.5216, 17MnV6
Sun gear	1.7131, 16MnCr5
Output shaft	1.4462, X2CrNiMoN22-5-3
Seal, gear chamber/prechamber	FKM
Sealing chamber	5.1301, EN-GJL-250
Seal on the fluid side	SiC/SiC, Q1Q1VGG
Seal bushing	1.4571, X6CrNiMoTi17-12-2
Propeller	1.4408, GX5CrNiMo19-11-2

Gear

Gear construction type	m 3.0 as per DIN 780-1:1977-05 /P10 (ISO54:1996-12); sun and planetary gears case hardened and sanded, internal gear butt-jointed
Gear bearings	3x2 needle roller bearing (planetary), two roller bearings (output shaft)
Service life L_{h10}	100,000 operating hours, ISO 281:2007-02

*maximum weight including accessories