

Zubehör - Accessories - Accessoires
Flumen OPTI/EXCEL TR22 .. TRE90-2 + Unipro TR36 .. TR75
Wandmontage - installation on wall - fixation au mur

wilo

Kunde
Customer
Client

Projekt
Project
Projet

Angebot - Quotation - Offre
Auftrag - Order - Commande
Nr. - No.:

Heimgartenstraße 1-3 D-95030 Hof/Saale
 Telefon +49 9281 974-0 Fax +49 9281 96528
 www.wilo.com E-Mail: info@wilo.com

- KMAT 6000236 - TR 22
- KMAT 6000247 - TR 36
- KMAT 6000248 - TR 40
- KMAT 6084655 - TR 30-1
- KMAT 6084654 - TR 40-1
- KMAT 6082835 - TRE 30
- KMAT 6084653 - TRE 40

- KMAT 6000249 - TR 50-2
- KMAT 6000250 - TR 60-2
- KMAT 6000251 - TR 75-2
- KMAT 6000253 - TR 90-2

- KMAT 6081572 - TRE 50-2
- KMAT 6081571 - TRE 60-2
- KMAT 6063567 - TRE 90-2

- KMAT 6091012 - TR 50-3
- KMAT 6091005 - TR 60-3
- KMAT 6091006 - TRE 50-3
- KMAT 6091011 - TRE 60-3

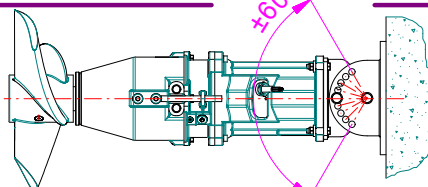
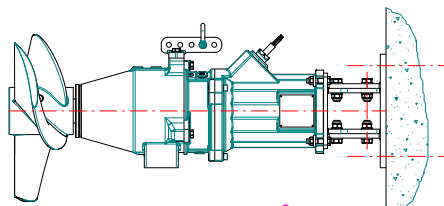
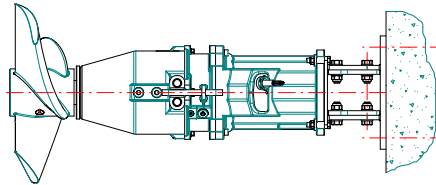
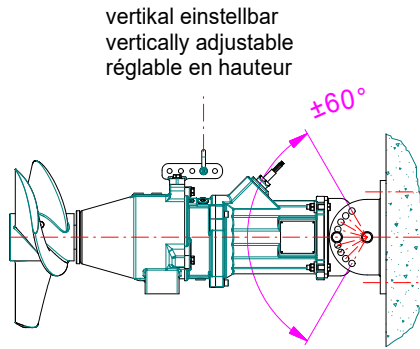
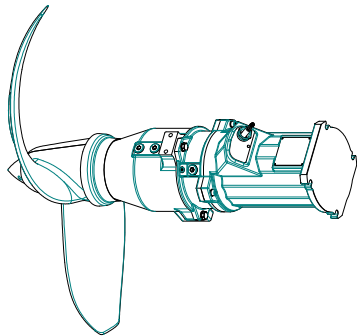
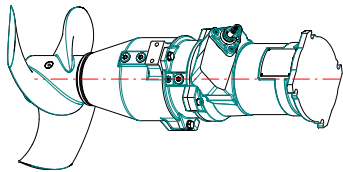
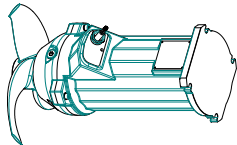
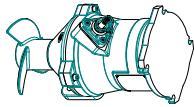

- 6010972
- 6011009

- 6010972
- 6011009

- 6011193
- 6011116

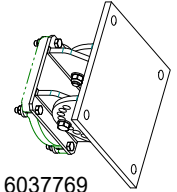
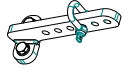

- 6037769

- 6010947 #1 (Ø10-17)
- 6010946 #2 (Ø17-26)
- 6011029 #3 (Ø26-36)
- 6061714 #1+3
- 6061715 #2+3

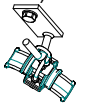

- 6011193
- 6011116

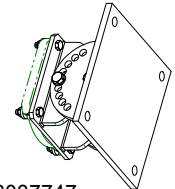
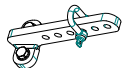

- 6037747

- 6010947 #1 (Ø10-17)
- 6010946 #2 (Ø17-26)
- 6011029 #3 (Ø26-36)
- 6061714 #1+3
- 6061715 #2+3

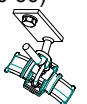

A4 = 1.4571 / AISI 316Ti / Z 6 CNDT 17-12

A2 = 1.4301 / AISI 304 / Z 7 CN 18-09

= Befestigungssatz / fixing elements /