

Wilo-Stratos MAXO

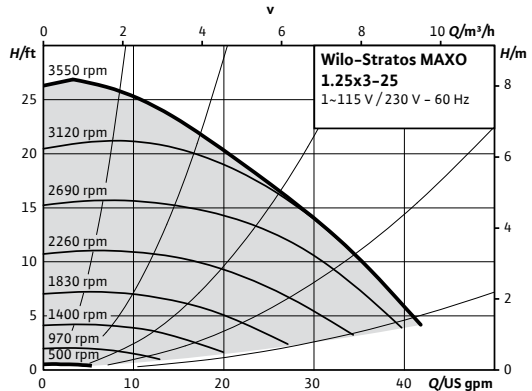

Project:	
Engineer:	
Contractor:	
Submitted By:	Date:
Approved By:	Date:

Tag #	Model #	Flow	Head	Control Mode	Cycle	Phase	Voltage
	Maxo 1.25x3-25				60Hz	1~	115/230-240V



Product Info

Brand	Wilo
Product Description	Stratos MAXO 1.25x3-25
Article Number	2164608
Net Weight (approx.)	16 lbs

Materials

Pump Housing	EN-GJL-250
Impeller	PPS-GF40
Shaft	X39CrMo17-1
Bearing	Carbon-graphite

Hydraulic Data

Max Operating Pressure PN	145 PSI
Min. Suction Head (122°F)	4.3 PSI
Min. Suction Head (203°F)	14.2 PSI
Min. Suction Head (230°F)	22.8 PSI
Min. Fluid Temp.	14°F
Max Fluid Temp.	230°F
Min. Ambient Temp	14°F
Max. Ambient Temp	104°F

Motor Data

Mains Connection	1-115V ±10%, 50/60Hz 1-230-240V ±10%, 50/60Hz
Motor Type	ECM
Rated Power P ₂	0.178 hp
Min. Speed n _{min}	500 RPM
Max. Speed n _{max}	3550 RPM
Power Consumption P _{3,max}	0.233 hp
Power Consumption P _{3,min}	0.009 hp
Max Current (1-230V) I _{max}	0.76 A
Min Current (1-230V) I _{min}	0.11 A
Max Current (1-115V) I _{max}	1.53 A
Min Current (1-115V) I _{min}	0.11 A
Insulation Class	F
Protection Class	Enclosure 2

CIF Module Selection

- BACnet MS/TP
- Modbus RTU
- CANopen
- LON TP/FT-10
- PLR

Accessory Selection

- Immersion Temp. Sensor PT 1000 AA
- Immersion Sleeve G ½", 45mm
- Pipe Surface Contact Sensor PT 1000 B
- Immersion Sleeve G ½", 100mm

Electrical Inputs

Analog Inputs (2x)	0-10V / 0-20mA / 4-20mA / PT 1000 Passive/Active +24V DC
Digital Inputs (2x)	Ext Off / Ext Min / Ext Max / Ext. MANUAL (BMS off) / External Key Lock / Switch heating, cooling
Wilo NET	Multi-Pump Communication
SSM	Fault Signal
SBM	Run Signal

Installation Dimensions

Pipe Connection (discharge)	1 ¼"
Pipe Connection (suction)	1 ¼"
Flange to Flange	6 ½"

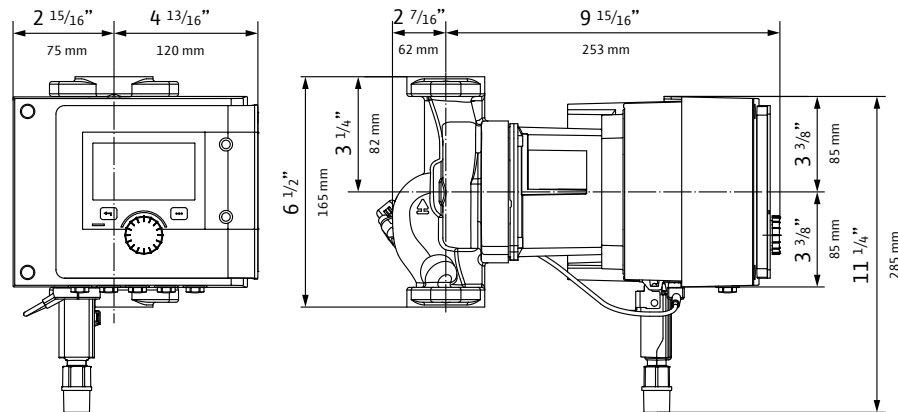
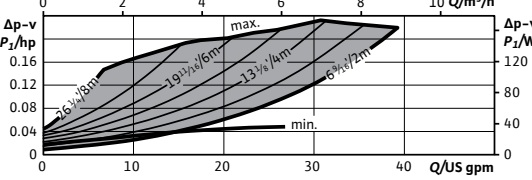
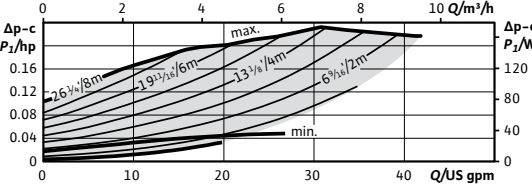
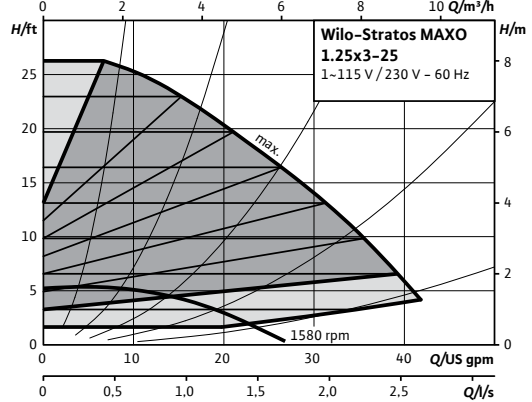
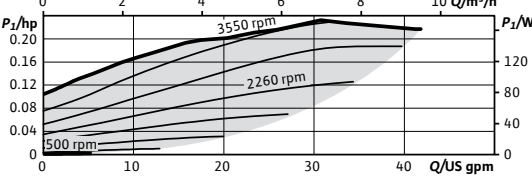
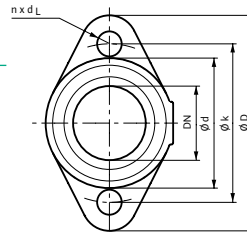

WILO USA LLC
+1 262 204-6600
www.wilo-usa.com
info.us@wilo.com

WILO Canada Inc.
+1 403 276-9456
www.wilo-canada.com
info@wilo-canada.com

WILO Mexico
+52 442 167 00 32
www.wilo-mexico.com
info@wilo.com.mx