

Wilo-Stratos MAXO

		Project:					
		Engineer:					
		Contractor:					
		Submitted By:			Date:		
		Approved By:			Date:		
Tag #	Model #	Flow	Head	Control Mode	Cycle	Phase	Voltage
	Maxo 3x3-40				60Hz	1~	230-240V

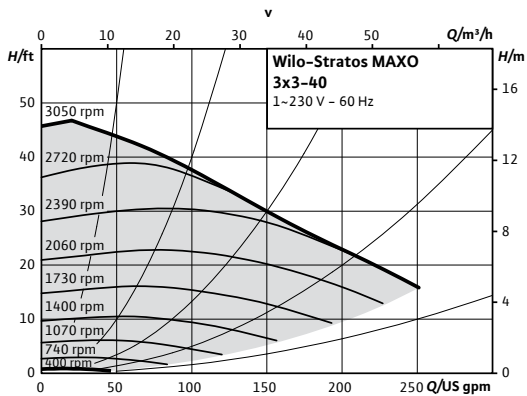

Product Info

Brand	Wilo
Product Description	Stratos MAXO 3x3-40
Article Number	2164618
Net Weight (approx.)	72 lbs

Materials

Pump Housing	EN-GJL-250
Impeller	PPS-GF40
Shaft	X30Cr13
Bearing	Carbon, antimony-impregnated

Hydraulic Data

Max Operating Pressure PN	145 PSI
Min. Suction Head (122°F)	10 PSI
Min. Suction Head (203°F)	21.3 PSI
Min. Suction Head (230°F)	32.7 PSI
Min. Fluid Temp.	14°F
Max Fluid Temp.	230°F
Min. Ambient Temp	14°F
Max. Ambient Temp	104°F

Motor Data

Mains Connection	1-230-240 V ±10%, 50/60Hz
Motor Type	ECM
Rated Power P <sub>2</sub>	1.641 hp
Min. Speed n <sub>min</sub>	400 RPM
Max. Speed n <sub>max</sub>	3050 RPM
Power Consumption P <sub>1,max</sub>	1.810 hp
Power Consumption P <sub>1,min</sub>	0.020 hp
Max Current (1-230V) I <sub>max</sub>	5.88 A
Min Current (1-230V) I <sub>min</sub>	0.3 A
Insulation Class	F
Protection Class	Enclosure 2

CIF Module Selection

- BACnet MS/TP
- Modbus RTU
- CANopen
- LON TP/FT-10
- PLR

Accessory Selection

- Immersion Temp. Sensor Pt 1000 AA
- Immersion Sleeve G ½", 45mm
- Pipe Surface Contact Sensor PT 1000 B
- Immersion Sleeve G ½", 100mm

Electrical Inputs

Analog Inputs (2x)	0-10V / 0-20mA / 4-20mA / PT 1000 Passive/Active +24V DC
Digital Inputs (2x)	Ext Off / Ext Min / Ext Max / Ext. MANUAL (BMS off) / External Key Lock / Switch heating, cooling
Wilo NET	Multi-Pump Communication
SSM	Fault Signal
SBM	Run Signal

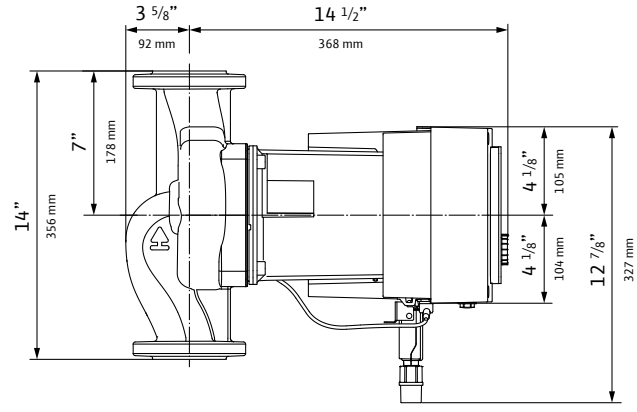
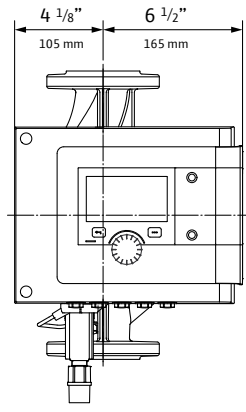
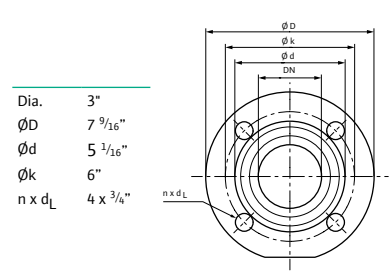
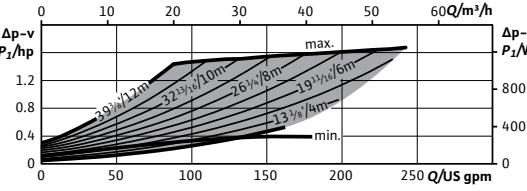
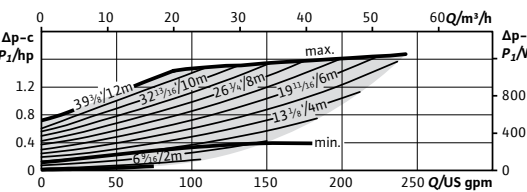
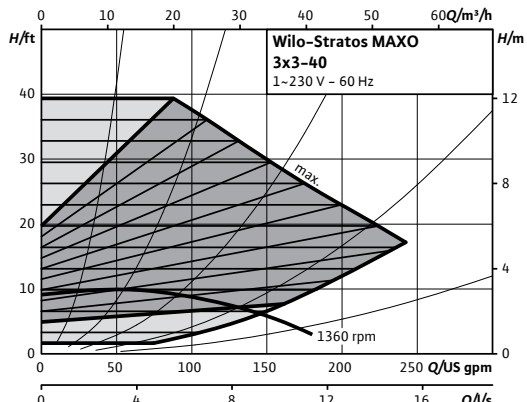
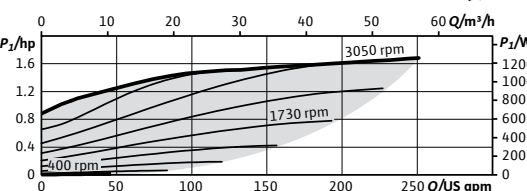

WILO USA LLC  
+1 262 204-6600  
www.wilo-usa.com  
info.us@wilo.com

WILO Canada Inc.  
+1 403 276-9456  
www.wilo-canada.com  
info@wilo-canada.com

WILO Mexico  
+52 442 167 00 32  
www.wilo-mexico.com  
info@wilo.com.mx