

Wilo-Stratos MAXO

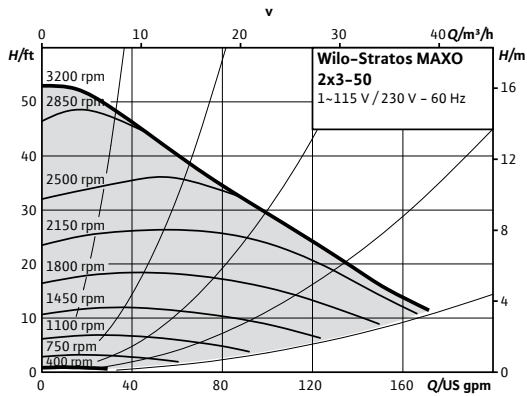

Project:	
Engineer:	
Contractor:	
Submitted By:	Date:
Approved By:	Date:

Tag #	Model #	Flow	Head	Control Mode	Cycle	Phase	Voltage
	Maxo 2x3-50				60Hz	1~	115/230-240V



Product Info

Brand	Wilo
Product Description	Stratos MAXO 2x3-50
Article Number	2164616
Net Weight (approx.)	64 lbs

Materials

Pump Housing	EN-GJL-250
Impeller	PPS-GF40
Shaft	X30Cr13
Bearing	Carbon, antimony-impregnated

Hydraulic Data

Max Operating Pressure PN	145 PSI
Min. Suction Head (122°F)	10 PSI
Min. Suction Head (203°F)	21.3 PSI
Min. Suction Head (230°F)	32.7 PSI
Min. Fluid Temp.	14°F
Max Fluid Temp.	230°F
Min. Ambient Temp	14°F
Max. Ambient Temp	104°F

Motor Data

Mains Connection	1-115V ±10%, 50/60Hz 1-230-240V ±10%, 50/60Hz
Motor Type	ECM
Rated Power P <sub>2</sub>	0.933 hp
Min. Speed n <sub>min</sub>	400 RPM
Max. Speed n <sub>max</sub>	3200 RPM
Power Consumption P <sub>3,max</sub>	1.106 hp
Power Consumption P <sub>1,min</sub>	0.027 hp
Max Current (1-230V) I <sub>max</sub>	3.49 A
Min Current (1-230V) I <sub>min</sub>	0.3 A
Max Current (1-115V) I <sub>max</sub>	7.19 A
Min Current (1-115V) I <sub>min</sub>	0.25 A
Insulation Class	F
Protection Class	Enclosure 2

CIF Module Selection

- BACnet MS/TP
- Modbus RTU
- CANopen
- LON TP/FT-10
- PLR

Accessory Selection

- Immersion Temp. Sensor PT 1000 AA
- Immersion Sleeve G ½", 45mm
- Pipe Surface Contact Sensor PT 1000 B
- Immersion Sleeve G ½", 100mm

Electrical Inputs

Analog Inputs (2x)	0-10V / 0-20mA / 4-20mA / PT 1000 Passive/Active +24V DC
Digital Inputs (2x)	Ext Off / Ext Min / Ext Max / Ext. MANUAL (BMS off) / External Key Lock / Switch heating, cooling
Wilo NET	Multi-Pump Communication
SSM	Fault Signal
SBM	Run Signal

Installation Dimensions

Pipe Connection (discharge)	2"
Pipe Connection (suction)	2"
Flange to Flange	13 7/16"

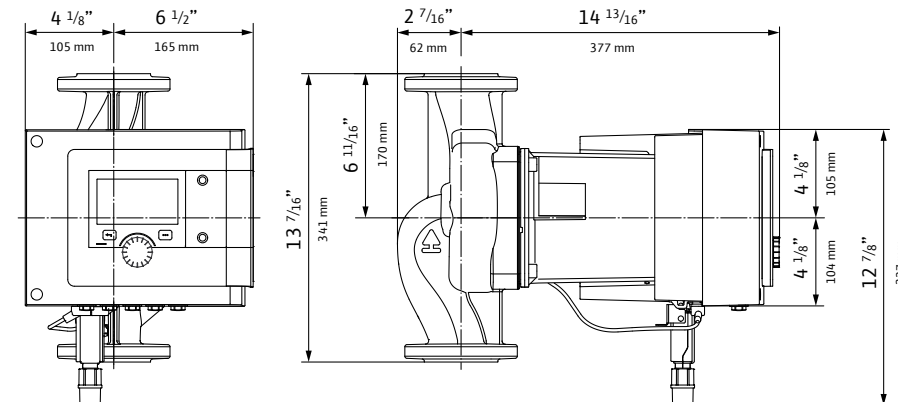
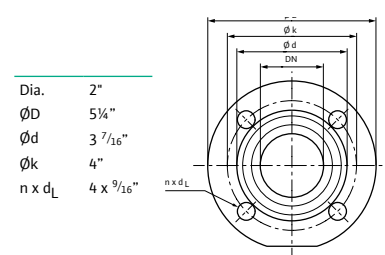
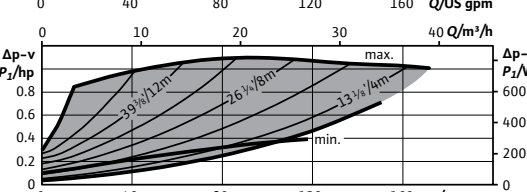
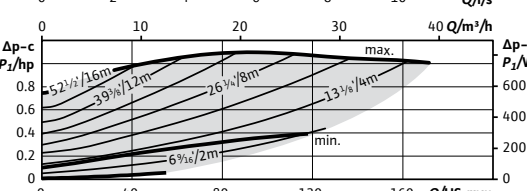
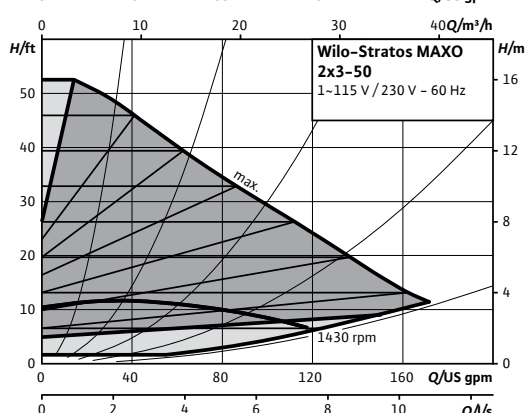
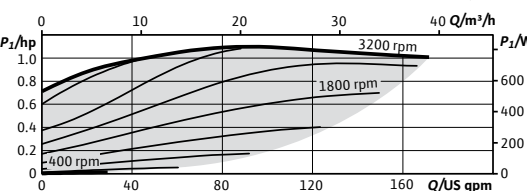

<p>WILO USA LLC +1 262 204-6600 www.wilo-usa.com info.us@wilo.com</p>	<p>WILO Canada Inc. +1 403 276-9456 www.wilo-canada.com info@wilo-canada.com</p>	<p>WILO Mexico +52 442 167 00 32 www.wilo-mexico.com info@wilo.com.mx</p>
---	--	---