

Wilo-Stratos MAXO

		Project:					
		Engineer:					
		Contractor:					
		Submitted By:			Date:		
		Approved By:			Date:		
Tag #	Model #	Flow	Head	Control Mode	Cycle	Phase	Voltage
	Maxo 2x3-35				60Hz	1~	230-240V

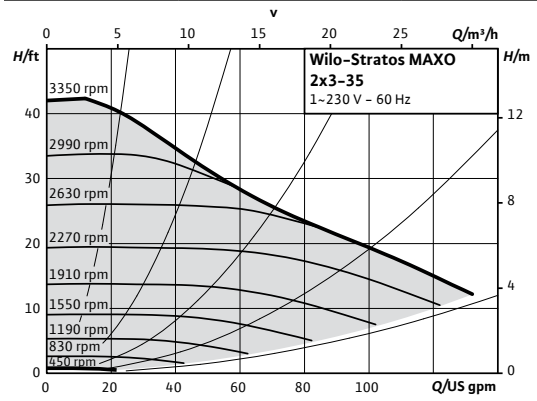

Product Info

Brand	Wilo
Product Description	Stratos MAXO 2x3-35
Article Number	2164615
Net Weight (approx.)	41 lbs

Materials

Pump Housing	EN-GJL-250
Impeller	PPS-GF40
Shaft	X30Cr13
Bearing	Carbon, antimony-impregnated

Hydraulic Data

Max Operating Pressure PN	145 PSI
Min. Suction Head (122°F)	7.1 PSI
Min. Suction Head (203°F)	17.1 PSI
Min. Suction Head (230°F)	25.6 PSI
Min. Fluid Temp.	14°F
Max Fluid Temp.	230°F
Min. Ambient Temp	14°F
Max. Ambient Temp	104°F

Motor Data

Mains Connection	1-230-240 V ±10%, 50/60Hz
Motor Type	ECM
Rated Power P ₂	0.652 hp
Min. Speed n _{min}	450 RPM
Max. Speed n _{max}	3550 RPM
Power Consumption P _{1,max}	0.734 hp
Power Consumption P _{1,min}	0.013 hp
Max Current (1-230V) I _{max}	2.39 A
Min Current (1-230V) I _{min}	0.2 A
Insulation Class	F
Protection Class	Enclosure 2

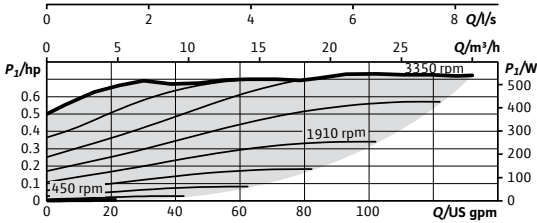

CIF Module Selection

- BACnet MS/TP
- Modbus RTU
- CANopen
- LON TP/FT-10
- PLR

Accessory Selection

- Immersion Temp. Sensor PT 1000 AA
- Immersion Sleeve G ½", 45mm
- Pipe Surface Contact Sensor PT 1000 B
- Immersion Sleeve G ½", 100mm

Electrical Inputs

Analog Inputs (2x)	0-10V / 0-20mA / 4-20mA / PT 1000 Passive/Active +24V DC
Digital Inputs (2x)	Ext Off / Ext Min / Ext Max / Ext. MANUAL (BMS off) / External Key Lock / Switch heating, cooling
Wilo NET	Multi-Pump Communication
SSM	Fault Signal
SBM	Run Signal

Installation Dimensions

Pipe Connection (discharge)	2"
Pipe Connection (suction)	2"
Flange to Flange	11"

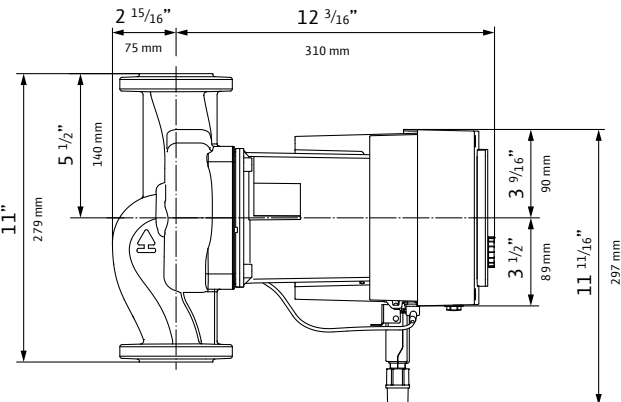
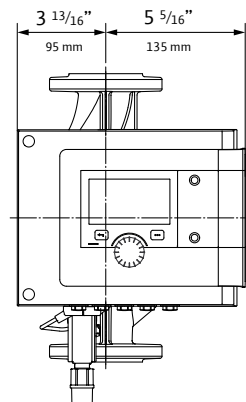
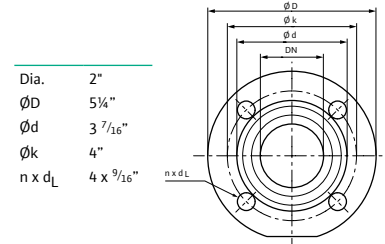
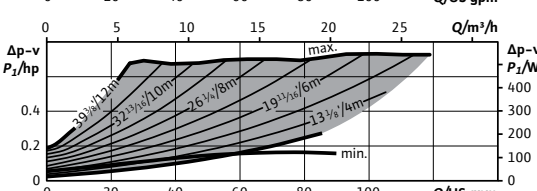
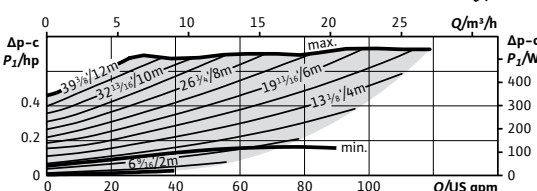
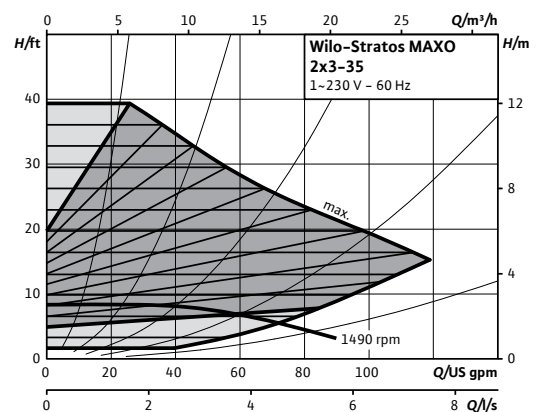

WILO USA LLC
+1 262 204-6600
www.wilo-usa.com
info.us@wilo.com

WILO Canada Inc.
+1 403 276-9456
www.wilo-canada.com
info@wilo-canada.com

WILO Mexico
+52 442 167 00 32
www.wilo-mexico.com
info@wilo.com.mx