

Submittal Data Sheet

Wilco CO-Helix - NSF 61/372 Pressure Boosting System



CO-3 HELIX V190-01/1-1/5/VCE



Project:	
Engineer:	
Contractor:	
Submitted By:	Date:
Approved By:	Date:

Tag #	Model #	Flow	BOOST PSI	Min. Inlet PSI	HP/Pump	Phase	Voltage	RPM
	CO-3 HELIX V190-01/1-1/5/VCE				5			3600

Article Number: 3313422 / 3313424 / 3313429 / 3313436

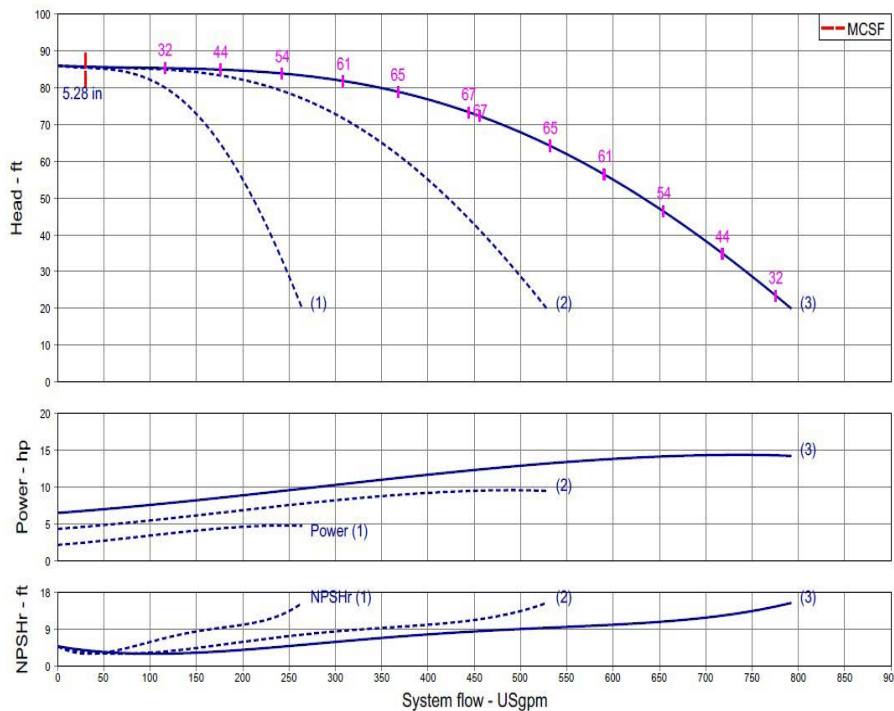

Applications

- Water Supply
- Pressure Boosting
- Agriculture
- Cooling Circuits
- Washing / Sprinkling Systems
- Condensate Return

Materials of Construction

Pump Volute	AISI304 stainless steel with ANSI flanges
Impeller	3D Laser welded AISI 304 Stainless Steel
Shaft	AISI304, AISI318 LN, or AISI431 Stainless Steel
Elastomers	EPDM
Manifolds	304 SS with 150 Class ANSI Flanges
Isolation Valves	Cast Iron Wafer Butterfly, All Stainless Steel Wetted Components
Check Valves	Cast Iron Body with All Stainless Steel Wetted Components, Spring-loaded non-slam
Mechanical Seal	Cartridge Seal: Sleeve AISI316L / Spring Clips AISI304
Pressure Transducers	316 Stainless Steel
Pressure Gauges	304 Stainless Steel Housing with 316 Stainless Steel wetted parts
System Base	Steel (S235JR)
Vibration Isolators	Neoprene, Height Adjustable

Technical Data - Operational Ranges

Liquid Temp Range	-4°F to +180°F (Min. 32 °F for Domestic Water)
Ambient Temp Range	+32°F to +104 °F
Max System Pressure	232 PSI

Technical Data - Panel

Power Supply	208-230/460-3 or 575-3
Enclosure	NEMA 12 (3R Available Upon Request)
Standard	Meets UL 508A
Variable Frequency Drives	Danfoss FC-51: • 1 to 5 HP for 208-230/460v-3 Danfoss FC-101: • 7.5 to 20HP 208-230V-3 • 1 to 10HP 208-230-1 IN / 208-230-3 OUT • 15 to 20HP 460V-3 • 1 to 20HP 575V-3

Technical Data - PLC

User Interface	7" Diagonal Color LCD Touchscreen
Display Resolution	800 x 480 Pixels
Supply Voltage	24VDC
Max. Current Consumption	320mA@24V
Number of Analog Inputs	9
Number of Analog Outputs	2
Number of Digital Inputs	18
Number of Digital Outputs	17
Onboard Communications	Modbus Protocol (Optional Gateways for BACnet, LonWorks, and CANbus)
Ethernet Port	RJ45 port capable of transmitting data 10/100Mbps
Additional Ports	2.0 USB Port; Micro-SD Port

Motor Data

Power Supply	208-230, 460, 575-3
Motor Enclosure	Totally Enclosed Fan Cooled (TEFC)
Motor Efficiency	Nema Premium Efficiency - Meets NEMA 12-12 Rule
Enclosure Construction	Rolled Steel / Cast Iron
Motor Protection Index	IP54
Insulation Class	F

Approval Stamp

Submittal Data Sheet

Wilo CO-Helix - NSF 61/372 Pressure Boosting System



CO-3 HELIX V190-01/1-1/5/VCE

208-230/460 V~3

208-230 V ~1In/~3Out/575 V~3

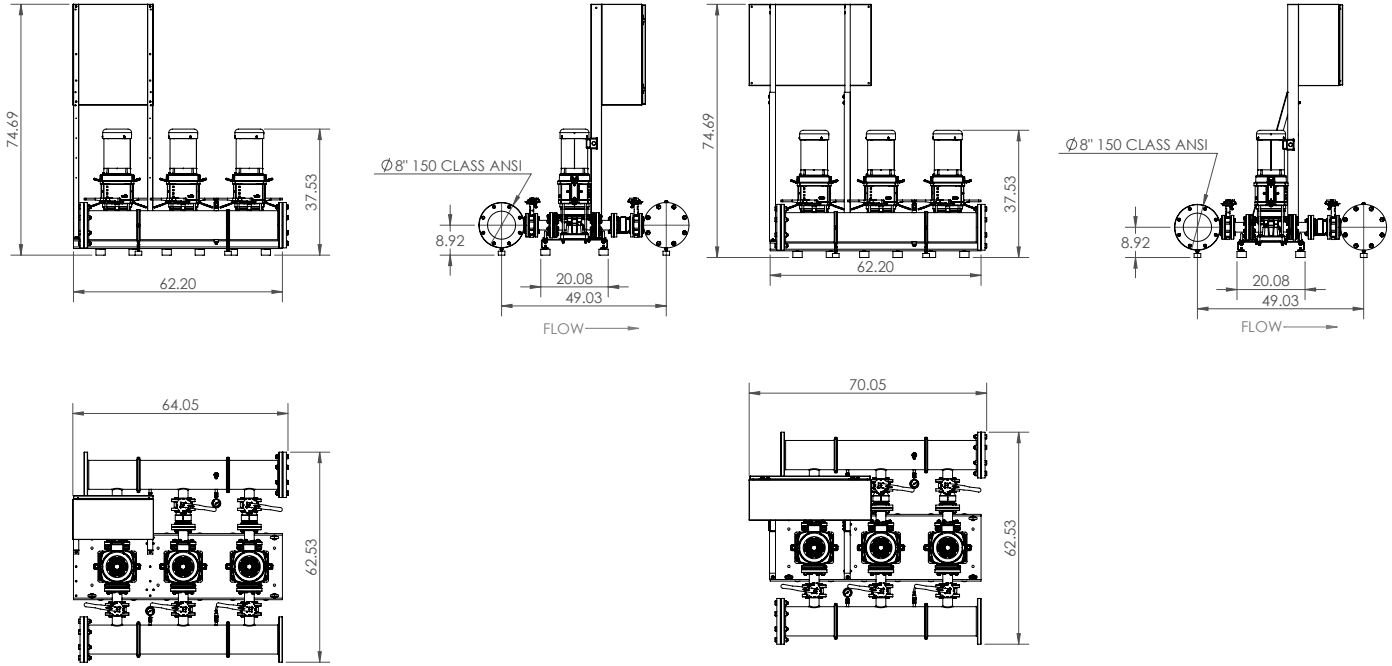

Special Note: All weights and dimensions are approximate and should not be used as exact rough-in dimensions

Dimensions and Weights

Model	Voltage (V)	H (in)	W (in)	L (in)	Dimensions-inches				Hydronumatic Tank Valve on Manifold (Plugged)	Individual Pump Weight Pump Weight (lbs)	Package Weight Package Weight (lbs)
					System Header Size	Suction / Discharge Pump Size (300 Class ANSI)	Gauge Tap Size	Transducer Tap Size			
CO-3 HELIX V190-01/1-1/5/VCE	208-230/460 V	74-2/3	64	62-1/2	8" 150 ANSI Class	2-1/2"	1/4" FNPT	1/4" FNPT	3/4" MNPT x 3/4" FNPT	204	1,416
	208-230 ~1in/~3out/575 V	74-2/3	70	62-1/2							

TEFC Motor Data

Model	P2	Phase	Voltage	FLA (per pump)	System FLA	Pmax
	(HP)	(-)	(V)	(A)		(PSI)
CO-3 HELIX V190-01/1-1/5/VCE	5	1	208-230 ~1in/~3out	13.1-11.8	73	232
		3	208-230/460/575	13.1-11.8/5.9/4.7	46.6/25.6/17.8	

Submittal Data Sheet

Wilco CO-Helix - NSF 61/372 Pressure Boosting System



CO-3 HELIX V190-01-1/7.5/VCE



Project:	
Engineer:	
Contractor:	
Submitted By:	Date:
Approved By:	Date:

Tag #	Model #	Flow	BOOST PSI	Min. Inlet PSI	HP/Pump	Phase	Voltage	RPM
	CO-3 HELIX V190-01-1/7.5/VCE				7.5			3600

Article Number: 3313423 / 3313425 / 3313430 / 3313437

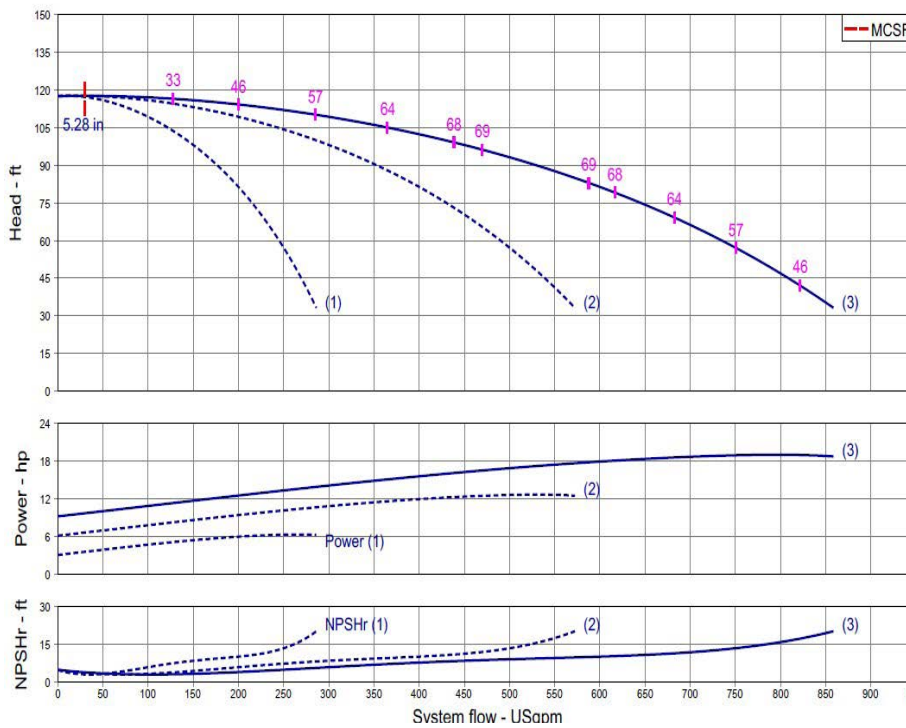

Applications

- Water Supply
- Pressure Boosting
- Agriculture
- Cooling Circuits
- Washing / Sprinkling Systems
- Condensate Return

Materials of Construction

Pump Volute	AISI304 stainless steel with ANSI flanges
Impeller	3D Laser welded AISI 304 Stainless Steel
Shaft	AISI304, AISI318 LN, or AISI431 Stainless Steel
Elastomers	EPDM
Manifolds	304 SS with 150 Class ANSI Flanges
Isolation Valves	Cast Iron Wafer Butterfly, All Stainless Steel Wetted Components
Check Valves	Cast Iron Body with All Stainless Steel Wetted Components, Spring-loaded non-slam
Mechanical Seal	Cartridge Seal: Sleeve AISI316L / Spring Clips AISI304
Pressure Transducers	316 Stainless Steel
Pressure Gauges	304 Stainless Steel Housing with 316 Stainless Steel wetted parts
System Base	Steel (S235JR)
Vibration Isolators	Neoprene, Height Adjustable

Technical Data - Operational Ranges

Liquid Temp Range	-4°F to +180°F (Min. 32 °F for Domestic Water)
Ambient Temp Range	+32°F to +104 °F
Max System Pressure	232 PSI

Technical Data - Panel

Power Supply	208-230/460-3 or 575-3
Enclosure	NEMA 12 (3R Available Upon Request)
Standard	Meets UL 508A
Variable Frequency Drives	Danfoss FC-51: • 1 to 5 HP for 208-230/460v-3 Danfoss FC-101: • 7.5 to 20HP 208-230V-3 • 1 to 10HP 208-230-1 IN / 208-230-3 OUT • 15 to 20HP 460V-3 • 1 to 20HP 575V-3

Technical Data - PLC

User Interface	7" Diagonal Color LCD Touchscreen
Display Resolution	800 x 480 Pixels
Supply Voltage	24VDC
Max. Current Consumption	320mA@24V
Number of Analog Inputs	9
Number of Analog Outputs	2
Number of Digital Inputs	18
Number of Digital Outputs	17
Onboard Communications	Modbus Protocol (Optional Gateways for BACnet, LonWorks, and CANbus)
Ethernet Port	RJ45 port capable of transmitting data 10/100Mbps
Additional Ports	2.0 USB Port; Micro-SD Port

Motor Data

Power Supply	208-230, 460, 575-3
Motor Enclosure	Totally Enclosed Fan Cooled (TEFC)
Motor Efficiency	Nema Premium Efficiency - Meets NEMA 12-12 Rule
Enclosure Construction	Rolled Steel / Cast Iron
Motor Protection Index	IP54
Insulation Class	F

Approval Stamp

Submittal Data Sheet

Wilo CO-Helix - NSF 61/372 Pressure Boosting System



CO-3 HELIX V190-01-1/7.5/VCE

208-230 V ~1In/~3Out

460 V ~3

208-230/575 V ~3

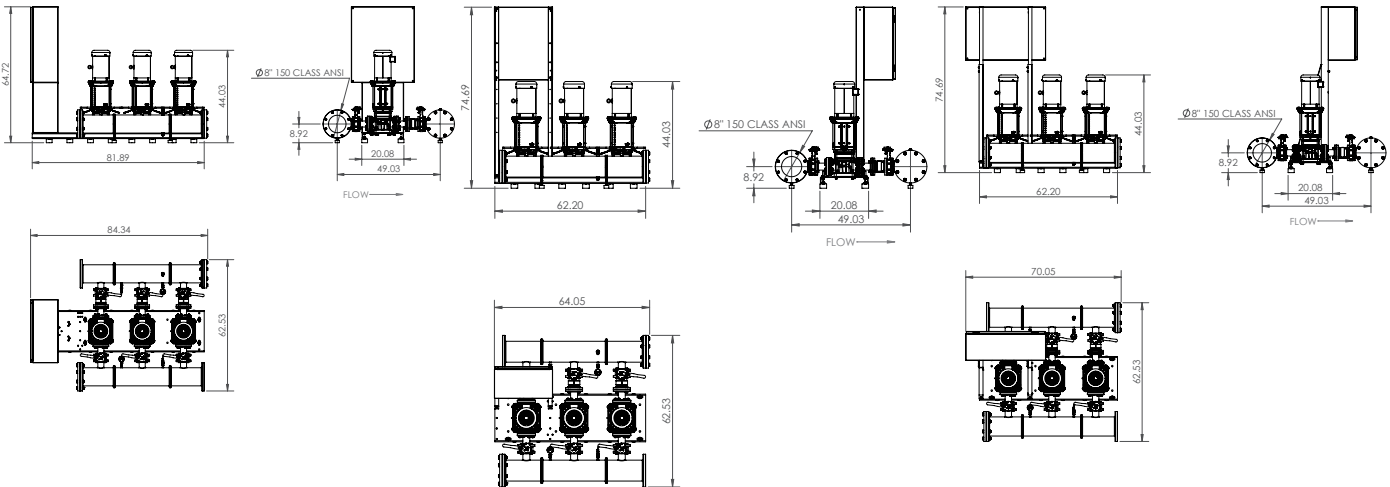

Special Note: All weights and dimensions are approximate and should not be used as exact rough-in dimensions

Dimensions and Weights

Model	Voltage (V)	H (in)	W (in)	L (in)	Dimensions-inches				Hydronumatic Tank Valve on Manifold (Plugged)	Individual Pump Weight	Package Weight
					System Header Size	Suction / Discharge Pump Size (300 Class ANSI)	Gauge Tap Size	Transducer Tap Size		Pump Weight (lbs)	Package Weight (lbs)
CO-3 HELIX V190-01-1/7.5/VCE	208-230 V ~1in/~3out	64-3/4	84-1/3	62-1/2	8" 150 ANSI Class	2-1/2"	1/4" FNPT	1/4" FNPT	3/4" MNPT x 3/4" FNPT	285	1,576
	460 V	74-2/3	64	62-1/2							
	208-230/575 V	74-3/4	70	62-1/2							

TEFC Motor Data

Model	P2 (HP)	Phase (-)	Voltage (V)	FLA (per pump) (A)	System FLA	Pmax (PSI)
CO-3 HELIX V190-01-1/7.5/VCE	7.5	1	208-230 ~1in/~3out	13.1-17.3	115.6	232
		3	208-230/460/575	13.1-17.3/8.7/6.9	64-55/34/25.9	

Submittal Data Sheet

Wilco CO-Helix - NSF 61/372 Pressure Boosting System



CO-3 HELIX V190-02/2-1/10/VCE



Project:	
Engineer:	
Contractor:	
Submitted By:	Date:
Approved By:	Date:

Tag #	Model #	Flow	BOOST PSI	Min. Inlet PSI	HP/Pump	Phase	Voltage	RPM
	CO-3 HELIX V190-02/2-1/10/VCE				10			3600

Article Number: 3313426 / 3313431 / 3313438

Applications

- Water Supply
- Pressure Boosting
- Agriculture
- Cooling Circuits
- Washing / Sprinkling Systems
- Condensate Return

Materials of Construction

Pump Volute	AISI304 stainless steel with ANSI flanges
Impeller	3D Laser welded AISI 304 Stainless Steel
Shaft	AISI304, AISI318 LN, or AISI431 Stainless Steel
Elastomers	EPDM
Manifolds	304 SS with 150 Class ANSI Flanges
Isolation Valves	Cast Iron Wafer Butterfly, All Stainless Steel Wetted Components
Check Valves	Cast Iron Body with All Stainless Steel Wetted Components, Spring-loaded non-slam
Mechanical Seal	Cartridge Seal: Sleeve AISI316L / Spring Clips AISI304
Pressure Transducers	316 Stainless Steel
Pressure Gauges	304 Stainless Steel Housing with 316 Stainless Steel wetted parts
System Base	Steel (S235JR)
Vibration Isolators	Neoprene, Height Adjustable

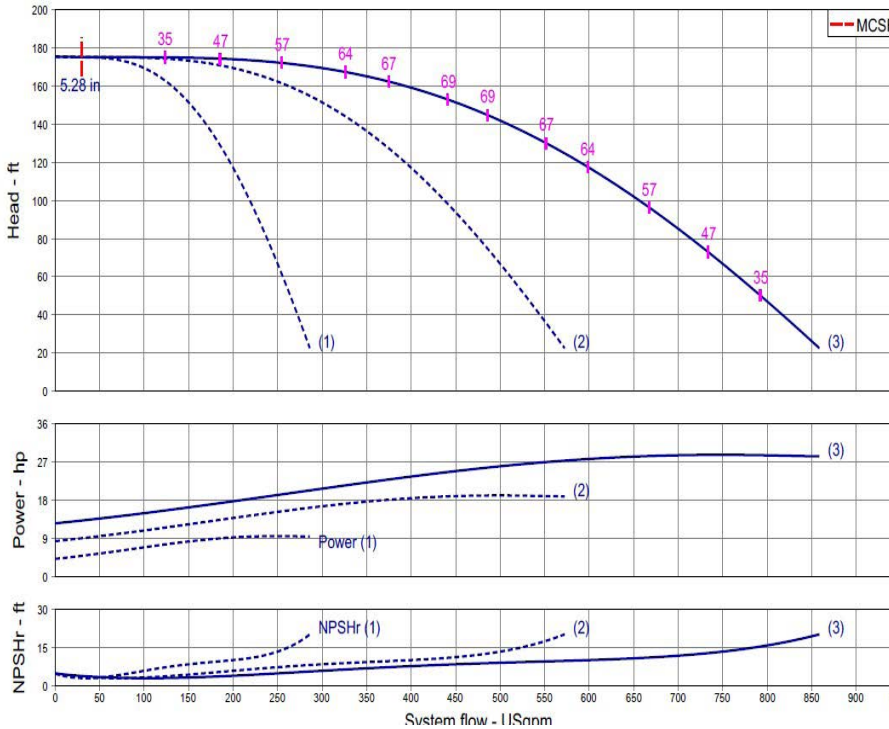

Technical Data - Operational Ranges

Liquid Temp Range	-4°F to +180°F (Min. 32 °F for Domestic Water)
Ambient Temp Range	+32°F to +104 °F
Max System Pressure	232 PSI

Technical Data - Panel

Power Supply	208-230/460-3 or 575-3
Enclosure	NEMA 12 (3R Available Upon Request)
Standard	Meets UL 508A
Variable Frequency Drives	Danfoss FC-51: • 1 to 5 HP for 208-230/460v-3 Danfoss FC-101: • 7.5 to 20HP 208-230V-3 • 1 to 10HP 208-230-1 IN / 208-230-3 OUT • 15 to 20HP 460V-3 • 1 to 20HP 575V-3

Technical Data - PLC

User Interface	7" Diagonal Color LCD Touchscreen
Display Resolution	800 x 480 Pixels
Supply Voltage	24VDC
Max. Current Consumption	320mA@24V
Number of Analog Inputs	9
Number of Analog Outputs	2
Number of Digital Inputs	18
Number of Digital Outputs	17
Onboard Communications	Modbus Protocol (Optional Gateways for BACnet, LonWorks, and CANbus)
Ethernet Port	RJ45 port capable of transmitting data 10/100Mbps
Additional Ports	2.0 USB Port; Micro-SD Port

Motor Data

Power Supply	208-230, 460, 575-3
Motor Enclosure	Totally Enclosed Fan Cooled (TEFC)
Motor Efficiency	Nema Premium Efficiency - Meets NEMA 12-12 Rule
Enclosure Construction	Rolled Steel / Cast Iron
Motor Protection Index	IP54
Insulation Class	F

Approval Stamp

Submittal Data Sheet

Wilo CO-Helix - NSF 61/372 Pressure Boosting System



CO-3 HELIX V190-02/2-1/10/VCE

460 V~3

208-230/575 V~3

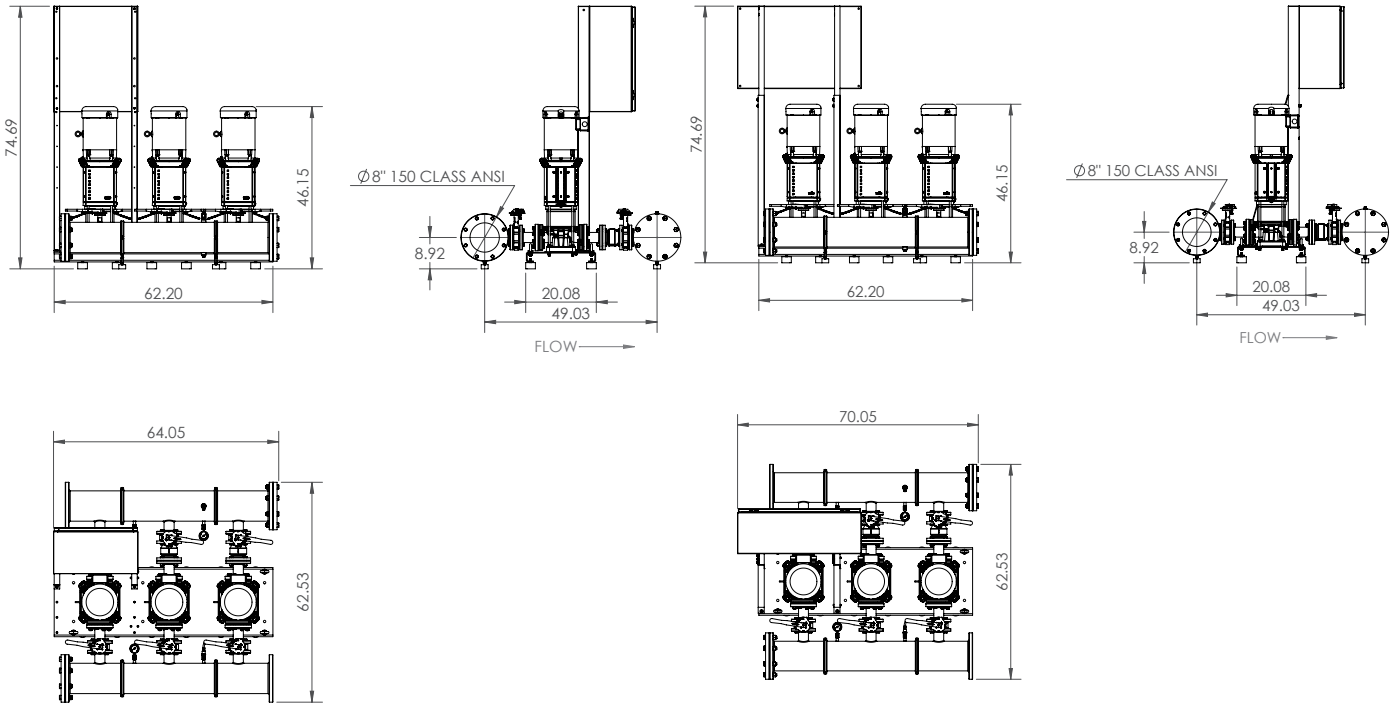

Special Note: All weights and dimensions are approximate and should not be used as exact rough-in dimensions

Dimensions and Weights

Model	Voltage (V)	H (in)	W (in)	L (in)	Dimensions-inches					Individual Pump Weight	Package Weight
					System Header Size	Suction / Discharge Pump Size (300 Class ANSI)	Gauge Tap Size	Transducer Tap Size	Hydrunomatic Tank Valve on Manifold (Plugged)	Pump Weight (lbs)	Package Weight (lbs)
CO-3 HELIX V190-02/2-1/10/VCE	208-230/575 V	74-3/4	70	62-1/2	8" 150 ANSI Class	2-1/2"	1/4" FNPT	1/4" FNPT	3/4" MNPT x 3/4" FNPT	315	1,677
	460 V	74-3/4	64	62-1/2	8" 150 ANSI Class	2-1/2"	1/4" FNPT	1/4" FNPT	3/4" MNPT x 3/4" FNPT	315	1,677

TEFC Motor Data

Model	P2 (HP)	Phase (-)	Voltage (V)	FLA (per pump) (A)	System FLA	Pmax (PSI)
CO-3 HELIX V190-02/2-1/10/VCE	10	3	208-230/460/575	25.4-23/11.5/9.2	85.9-73/43/35.2	232

Submittal Data Sheet

Wilco CO-Helix - NSF 61/372 Pressure Boosting System



CO-3 HELIX V190-02/1-1/15/VCE



Project:	
Engineer:	
Contractor:	
Submitted By:	Date:
Approved By:	Date:

Tag #	Model #	Flow	BOOST PSI	Min. Inlet PSI	HP/Pump	Phase	Voltage	RPM
	CO-3 HELIX V190-02/1-1/15/VCE				15			3600

Article Number: 3313427 / 3313432 / 3313439

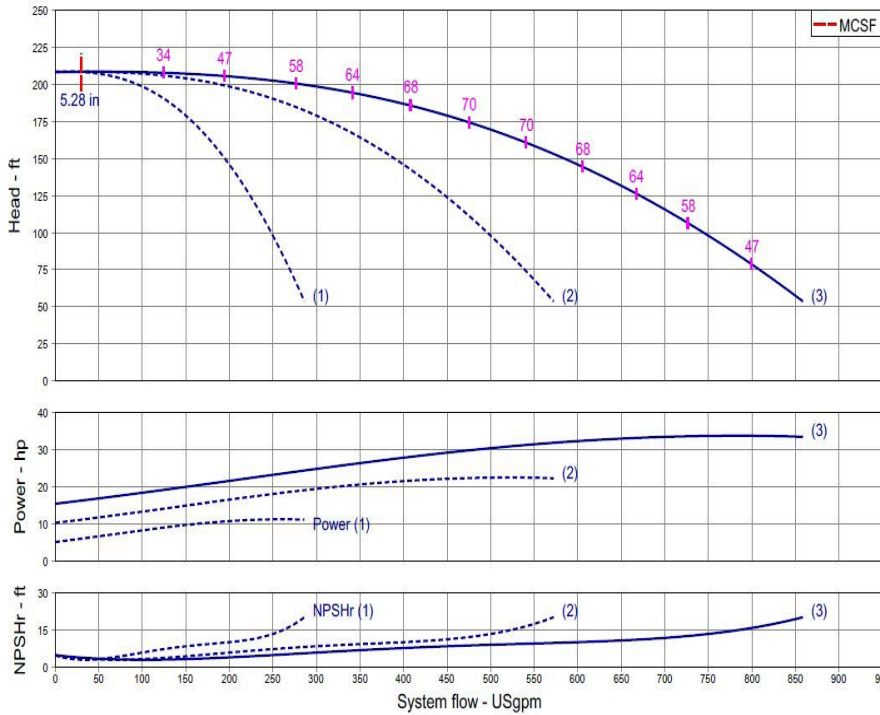

Applications

- Water Supply
- Pressure Boosting
- Agriculture
- Cooling Circuits
- Washing / Sprinkling Systems
- Condensate Return

Materials of Construction

Pump Volute	AISI304 stainless steel with ANSI flanges
Impeller	3D Laser welded AISI 304 Stainless Steel
Shaft	AISI304, AISI318 LN, or AISI431 Stainless Steel
Elastomers	EPDM
Manifolds	304 SS with 150 Class ANSI Flanges
Isolation Valves	Cast Iron Wafer Butterfly, All Stainless Steel Wetted Components
Check Valves	Cast Iron Body with All Stainless Steel Wetted Components, Spring-loaded non-slam
Mechanical Seal	Cartridge Seal: Sleeve AISI316L / Spring Clips AISI304
Pressure Transducers	316 Stainless Steel
Pressure Gauges	304 Stainless Steel Housing with 316 Stainless Steel wetted parts
System Base	Steel (S235JR)
Vibration Isolators	Neoprene, Height Adjustable

Technical Data - Operational Ranges

Liquid Temp Range	-4°F to +180°F (Min. 32 °F for Domestic Water)
Ambient Temp Range	+32°F to +104 °F
Max System Pressure	232 PSI

Technical Data - Panel

Power Supply	208-230/460-3 or 575-3
Enclosure	NEMA 12 (3R Available Upon Request)
Standard	Meets UL 508A
Variable Frequency Drives	Danfoss FC-51: • 1 to 5 HP for 208-230/460v-3 Danfoss FC-101: • 7.5 to 20HP 208-230V-3 • 1 to 10HP 208-230-1 IN / 208-230-3 OUT • 15 to 20HP 460V-3 • 1 to 20HP 575V-3

Technical Data - PLC

User Interface	7" Diagonal Color LCD Touchscreen
Display Resolution	800 x 480 Pixels
Supply Voltage	24VDC
Max. Current Consumption	320mA@24V
Number of Analog Inputs	9
Number of Analog Outputs	2
Number of Digital Inputs	18
Number of Digital Outputs	17
Onboard Communications	Modbus Protocol (Optional Gateways for BACnet, LonWorks, and CANbus)
Ethernet Port	RJ45 port capable of transmitting data 10/100Mbps
Additional Ports	2.0 USB Port; Micro-SD Port

Motor Data

Power Supply	208-230, 460, 575-3
Motor Enclosure	Totally Enclosed Fan Cooled (TEFC)
Motor Efficiency	Nema Premium Efficiency - Meets NEMA 12-12 Rule
Enclosure Construction	Rolled Steel / Cast Iron
Motor Protection Index	IP54
Insulation Class	F

Approval Stamp

Submittal Data Sheet

Wilo CO-Helix - NSF 61/372 Pressure Boosting System



CO-3 HELIX V190-02/1-1/15/VCE

208-230 V~3

460 V~3

575 V~3

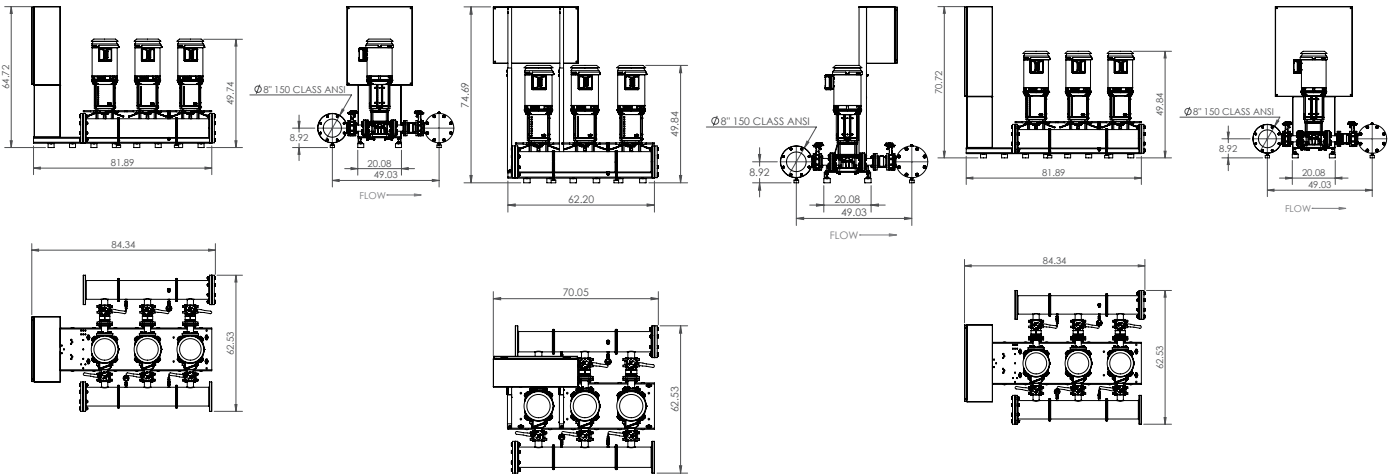

Special Note: All weights and dimensions are approximate and should not be used as exact rough-in dimensions

Dimensions and Weights

Model	Voltage (V)	H (in)	W (in)	L (in)	Dimensions-inches					Individual Pump Weight	Package Weight
					System Header Size	Suction / Discharge Pump Size (300 Class ANSI)	Gauge Tap Size	Transducer Tap Size	Hydronumatic Tank Valve on Manifold (Plugged)	Pump Weight (lbs)	Package Weight (lbs)
CO-3 HELIX V190-02/1-1/15/VCE	208-230 V	64-3/4	84-1/3	62-1/2	8" 150 ANSI Class	2-1/2"	1/4" FNPT	1/4" FNPT	3/4" MNPT x 3/4" FNPT	332	1,894
	460 V	74-2/3	70	62-1/2							
	575 V	70-3/4	84-1/3	62-1/2							

TEFC Motor Data

Model	P2 (HP)	Phase (-)	Voltage (V)	FLA (per pump) (A)	System FLA	Pmax (PSI)
CO-3 HELIX V190-02/1-1/15/VCE	15	3	208-230/460/575	38.5-34.8/17.4/13.8	124-115.6/56.2/48.1	232

Submittal Data Sheet

Wilco CO-Helix - NSF 61/372 Pressure Boosting System



CO-3 HELIX V190-02-1/15/VCE



Project:	
Engineer:	
Contractor:	
Submitted By:	Date:
Approved By:	Date:

Tag #	Model #	Flow	BOOST PSI	Min. Inlet PSI	HP/Pump	Phase	Voltage	RPM
	CO-3 HELIX V190-02-1/15/VCE				15			3600

Article Number: 3313428 / 3313433 / 3313440

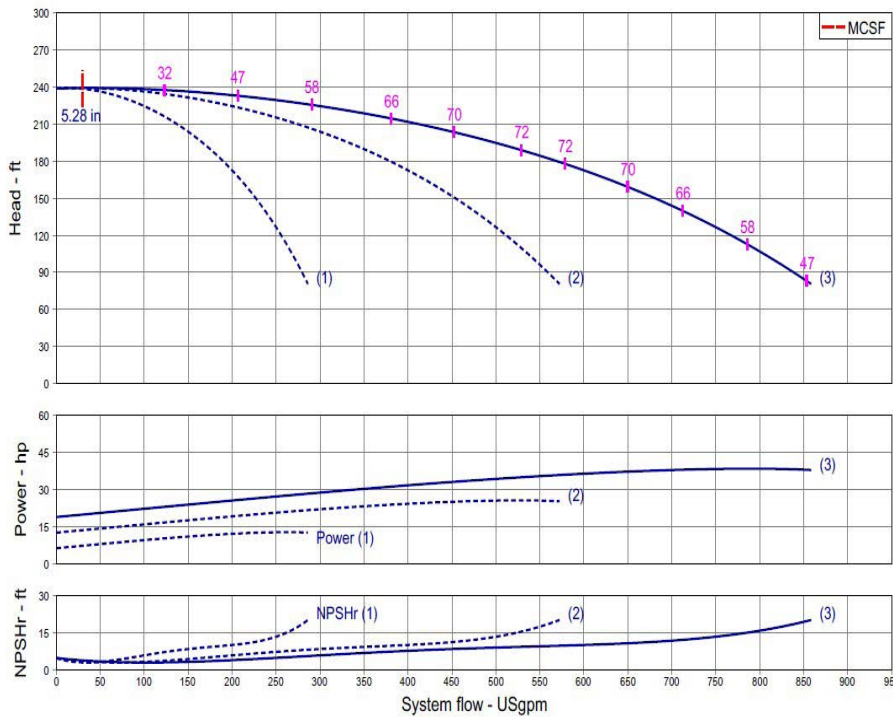

Applications

- Water Supply
- Pressure Boosting
- Agriculture
- Cooling Circuits
- Washing / Sprinkling Systems
- Condensate Return

Materials of Construction

Pump Volute	AISI304 stainless steel with ANSI flanges
Impeller	3D Laser welded AISI 304 Stainless Steel
Shaft	AISI304, AISI318 LN, or AISI431 Stainless Steel
Elastomers	EPDM
Manifolds	304 SS with 150 Class ANSI Flanges
Isolation Valves	Cast Iron Wafer Butterfly, All Stainless Steel Wetted Components
Check Valves	Cast Iron Body with All Stainless Steel Wetted Components, Spring-loaded non-slam
Mechanical Seal	Cartridge Seal: Sleeve AISI316L / Spring Clips AISI304
Pressure Transducers	316 Stainless Steel
Pressure Gauges	304 Stainless Steel Housing with 316 Stainless Steel wetted parts
System Base	Steel (S235JR)
Vibration Isolators	Neoprene, Height Adjustable

Technical Data - Operational Ranges

Liquid Temp Range	-4°F to +180°F (Min. 32 °F for Domestic Water)
Ambient Temp Range	+32°F to +104 °F
Max System Pressure	232 PSI

Technical Data - Panel

Power Supply	208-230/460-3 or 575-3
Enclosure	NEMA 12 (3R Available Upon Request)
Standard	Meets UL 508A
Variable Frequency Drives	Danfoss FC-51: • 1 to 5 HP for 208-230/460v-3 Danfoss FC-101: • 7.5 to 20HP 208-230V-3 • 1 to 10HP 208-230-1 IN / 208-230-3 OUT • 15 to 20HP 460V-3 • 1 to 20HP 575V-3

Technical Data - PLC

User Interface	7" Diagonal Color LCD Touchscreen
Display Resolution	800 x 480 Pixels
Supply Voltage	24VDC
Max. Current Consumption	320mA@24V
Number of Analog Inputs	9
Number of Analog Outputs	2
Number of Digital Inputs	18
Number of Digital Outputs	17
Onboard Communications	Modbus Protocol (Optional Gateways for BACnet, LonWorks, and CANbus)
Ethernet Port	RJ45 port capable of transmitting data 10/100Mbps
Additional Ports	2.0 USB Port; Micro-SD Port

Motor Data

Power Supply	208-230, 460, 575-3
Motor Enclosure	Totally Enclosed Fan Cooled (TEFC)
Motor Efficiency	Nema Premium Efficiency - Meets NEMA 12-12 Rule
Enclosure Construction	Rolled Steel / Cast Iron
Motor Protection Index	IP54
Insulation Class	F

Approval Stamp

Submittal Data Sheet

Wilo CO-Helix - NSF 61/372 Pressure Boosting System



CO-3 HELIX V190-02-1/15/VCE

208-230 V~3

460 V~3

575 V~3

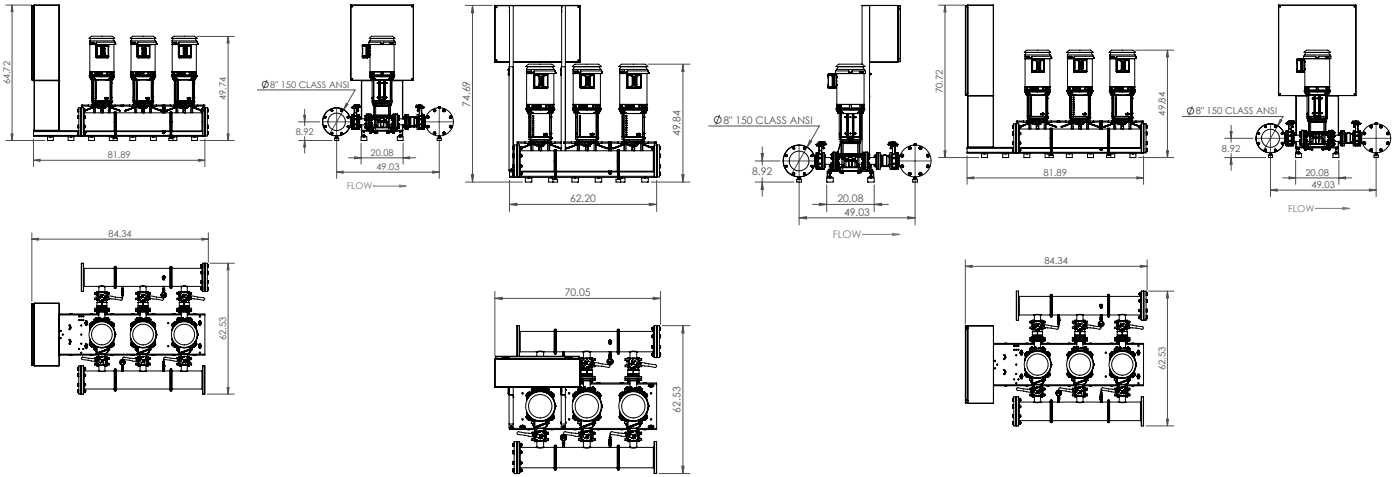

Special Note: All weights and dimensions are approximate and should not be used as exact rough-in dimensions

Dimensions and Weights

Model	Voltage (V)	H (in)	W (in)	L (in)	Dimensions-inches					Individual Pump Weight (lbs)	Package Weight (lbs)
					System Header Size	Suction / Discharge Pump Size (300 Class ANSI)	Gauge Tap Size	Transducer Tap Size	Hydronumatic Tank Valve on Manifold (Plugged)		
CO-3 HELIX V190-02-1/15/VCE	208-230 V	64-3/4	84-1/3	62-1/2	8" 150 ANSI Class	2-1/2"	1/4" FNPT	1/4" FNPT	3/4" MNPT x 3/4" FNPT	332	1,894
	460 V	74-2/3	70	62-1/2							
	575 V	70-3/4	84-1/3	62-1/2							

TEFC Motor Data

Model	P2 (HP)	Phase (-)	Voltage (V)	FLA (per pump) (A)	System FLA	Pmax (PSI)
CO-3 HELIX V190-02-1/15/VCE	15	3	208-230/460/575	38.5-34.8/17.4/13.8	124-115.6/56.2/48.1	232

Submittal Data Sheet

Wilco CO-Helix - NSF 61/372 Pressure Boosting System



CO-3 HELIX V190-03/2-1/20/VCE



Project:	
Engineer:	
Contractor:	
Submitted By:	Date:
Approved By:	Date:

Tag #	Model #	Flow	BOOST PSI	Min. Inlet PSI	HP/Pump	Phase	Voltage	RPM
	CO-3 HELIX V190-03/2-1/20/VCE				20			3600

Article Number: 3327850 / 3313394 / 3313441

Applications

- Water Supply
- Pressure Boosting
- Agriculture
- Cooling Circuits
- Washing / Sprinkling Systems
- Condensate Return

Materials of Construction

Pump Volute	AISI304 stainless steel with ANSI flanges
Impeller	3D Laser welded AISI 304 Stainless Steel
Shaft	AISI304, AISI318 LN, or AISI431 Stainless Steel
Elastomers	EPDM
Manifolds	304 SS with 150 Class ANSI Flanges
Isolation Valves	Cast Iron Wafer Butterfly, All Stainless Steel Wetted Components
Check Valves	Cast Iron Body with All Stainless Steel Wetted Components, Spring-loaded non-slam
Mechanical Seal	Cartridge Seal: Sleeve AISI316L / Spring Clips AISI304
Pressure Transducers	316 Stainless Steel
Pressure Gauges	304 Stainless Steel Housing with 316 Stainless Steel wetted parts
System Base	Steel (S235JR)
Vibration Isolators	Neoprene, Height Adjustable

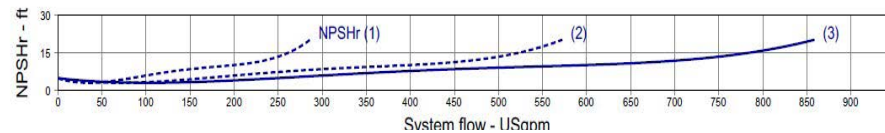
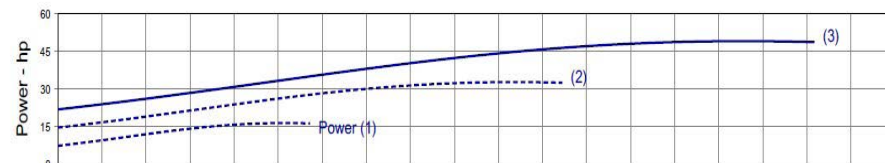
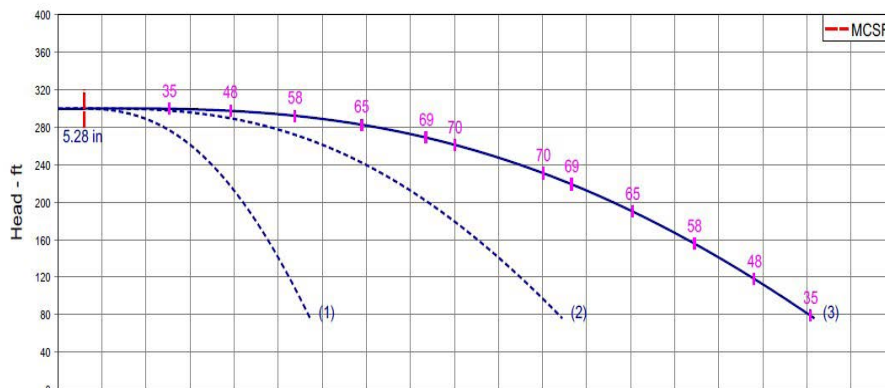

Technical Data - Operational Ranges

Liquid Temp Range	-4°F to +180°F (Min. 32 °F for Domestic Water)
Ambient Temp Range	+32°F to +104 °F
Max System Pressure	232 PSI

Technical Data - Panel

Power Supply	208-230/460-3 or 575-3
Enclosure	NEMA 12 (3R Available Upon Request)
Standard	Meets UL 508A
Variable Frequency Drives	Danfoss FC-51: • 1 to 5 HP for 208-230/460v-3 Danfoss FC-101: • 7.5 to 20HP 208-230V-3 • 1 to 10HP 208-230-1 IN / 208-230-3 OUT • 15 to 20HP 460V-3 • 1 to 20HP 575V-3

Technical Data - PLC

User Interface	7" Diagonal Color LCD Touchscreen
Display Resolution	800 x 480 Pixels
Supply Voltage	24VDC
Max. Current Consumption	320mA@24V
Number of Analog Inputs	9
Number of Analog Outputs	2
Number of Digital Inputs	18
Number of Digital Outputs	17
Onboard Communications	Modbus Protocol (Optional Gateways for BACnet, LonWorks, and CANbus)
Ethernet Port	RJ45 port capable of transmitting data 10/100Mbps
Additional Ports	2.0 USB Port; Micro-SD Port

Motor Data

Power Supply	208-230, 460, 575-3
Motor Enclosure	Totally Enclosed Fan Cooled (TEFC)
Motor Efficiency	Nema Premium Efficiency - Meets NEMA 12-12 Rule
Enclosure Construction	Rolled Steel / Cast Iron
Motor Protection Index	IP54
Insulation Class	F

Approval Stamp

Submittal Data Sheet

Wilo CO-Helix - NSF 61/372 Pressure Boosting System



CO-3 HELIX V190-03/2-1/20/VCE

208-230 V~3

460 V~3

575 V~3

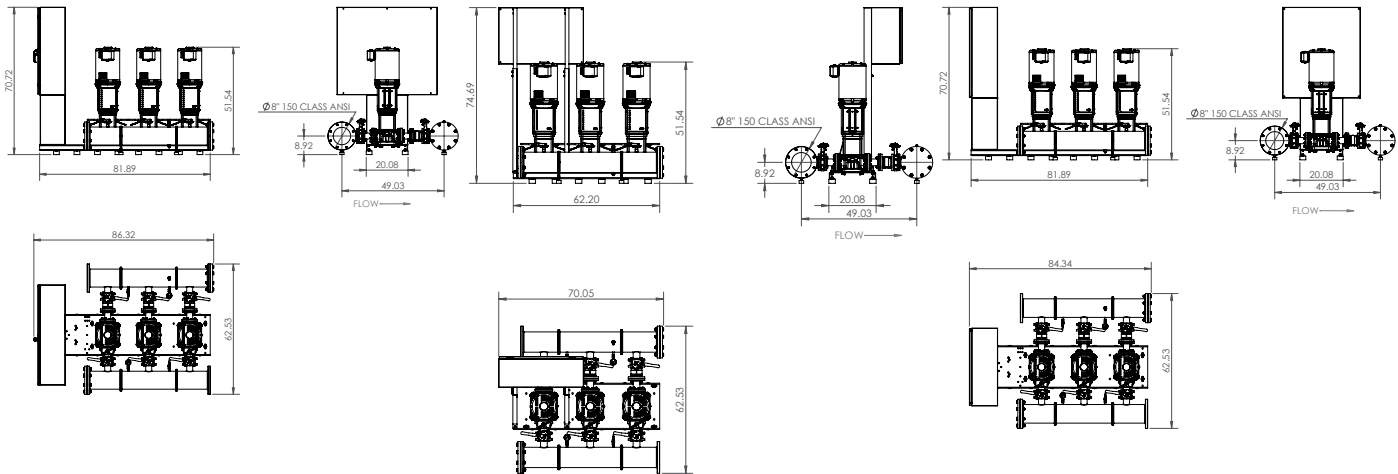

Special Note: All weights and dimensions are approximate and should not be used as exact rough-in dimensions

Dimensions and Weights

Model	Voltage (V)	H (in)	W (in)	L (in)	Dimensions-inches					Individual Pump Weight	Package Weight
					System Header Size	Suction / Discharge Pump Size (300 Class ANSI)	Gauge Tap Size	Transducer Tap Size	Hydrunumatic Tank Valve on Manifold (Plugged)	Pump Weight (lbs)	Package Weight (lbs)
CO-3 HELIX V190-03/2-1/20/VCE	208-230 V	70-3/4	86-1/3	62-1/2	8" 150 ANSI Class	2-1/2"	1/4" FNPT	1/4" FNPT	3/4" MNPT x 3/4" FNPT	383	2,177
	460 V	74-2/3	70	62-1/2							
	575 V	70-3/4	84-1/3	62-1/2							

TEFC Motor Data

Model	P2 (HP)	Phase (-)	Voltage (V)	FLA (per pump) (A)	System FLA	Pmax (PSI)
CO-3 HELIX V190-03/2-1/20/VCE	20	3	208-230/460/575	50.2-45.4/22.7/18.2	159.1/75.1/65.2	232

Submittal Data Sheet

Wilco CO-Helix - NSF 61/372 Pressure Boosting System



CO-3 HELIX V190-03/1-1/20/VCE



Project:	
Engineer:	
Contractor:	
Submitted By:	Date:
Approved By:	Date:

Tag #	Model #	Flow	BOOST PSI	Min. Inlet PSI	HP/Pump	Phase	Voltage	RPM
	CO-3 HELIX V190-03/1-1/20/VCE				20			3600

Article Number: 3327851 / 3313434 / 3313442

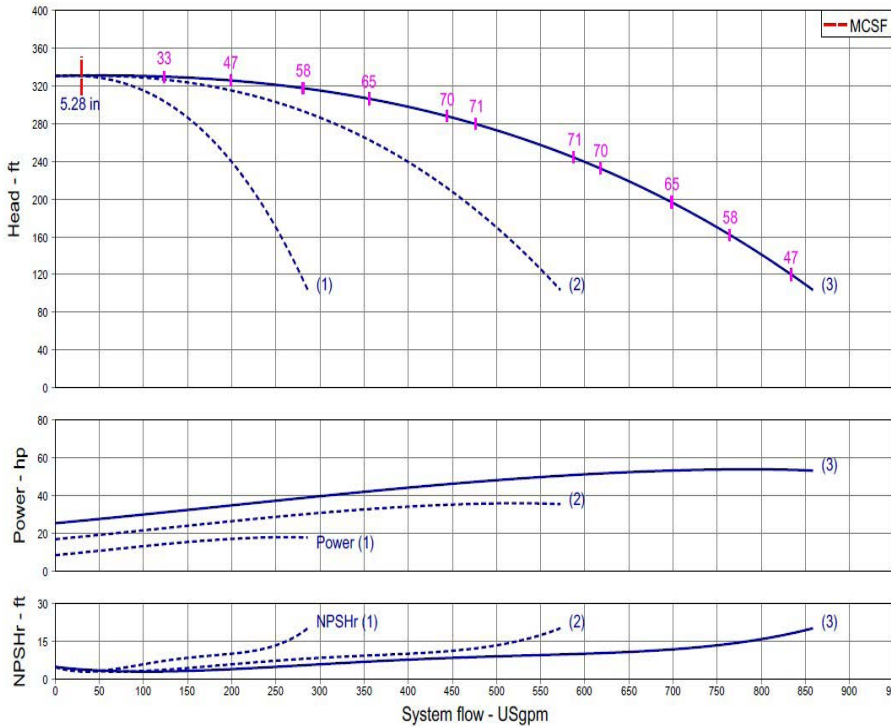

Applications

- Water Supply
- Pressure Boosting
- Agriculture
- Cooling Circuits
- Washing / Sprinkling Systems
- Condensate Return

Materials of Construction

Pump Volute	AISI304 stainless steel with ANSI flanges
Impeller	3D Laser welded AISI 304 Stainless Steel
Shaft	AISI304, AISI318 LN, or AISI431 Stainless Steel
Elastomers	EPDM
Manifolds	304 SS with 150 Class ANSI Flanges
Isolation Valves	Cast Iron Wafer Butterfly, All Stainless Steel Wetted Components
Check Valves	Cast Iron Body with All Stainless Steel Wetted Components, Spring-loaded non-slam
Mechanical Seal	Cartridge Seal: Sleeve AISI316L / Spring Clips AISI304
Pressure Transducers	316 Stainless Steel
Pressure Gauges	304 Stainless Steel Housing with 316 Stainless Steel wetted parts
System Base	Steel (S235JR)
Vibration Isolators	Neoprene, Height Adjustable

Technical Data - Operational Ranges

Liquid Temp Range	-4°F to +180°F (Min. 32 °F for Domestic Water)
Ambient Temp Range	+32°F to +104 °F
Max System Pressure	232 PSI

Technical Data - Panel

Power Supply	208-230/460-3 or 575-3
Enclosure	NEMA 12 (3R Available Upon Request)
Standard	Meets UL 508A
Variable Frequency Drives	Danfoss FC-51: • 1 to 5 HP for 208-230/460v-3 Danfoss FC-101: • 7.5 to 20HP 208-230V-3 • 1 to 10HP 208-230-1 IN / 208-230-3 OUT • 15 to 20HP 460V-3 • 1 to 20HP 575V-3

Technical Data - PLC

User Interface	7" Diagonal Color LCD Touchscreen
Display Resolution	800 x 480 Pixels
Supply Voltage	24VDC
Max. Current Consumption	320mA@24V
Number of Analog Inputs	9
Number of Analog Outputs	2
Number of Digital Inputs	18
Number of Digital Outputs	17
Onboard Communications	Modbus Protocol (Optional Gateways for BACnet, LonWorks, and CANbus)
Ethernet Port	RJ45 port capable of transmitting data 10/100Mbps
Additional Ports	2.0 USB Port; Micro-SD Port

Motor Data

Power Supply	208-230, 460, 575-3
Motor Enclosure	Totally Enclosed Fan Cooled (TEFC)
Motor Efficiency	Nema Premium Efficiency - Meets NEMA 12-12 Rule
Enclosure Construction	Rolled Steel / Cast Iron
Motor Protection Index	IP54
Insulation Class	F

Approval Stamp

Submittal Data Sheet

Wilo CO-Helix - NSF 61/372 Pressure Boosting System



CO-3 HELIX V190-03/1-1/20/VCE

208-230 V~3

460 V~3

575 V~3

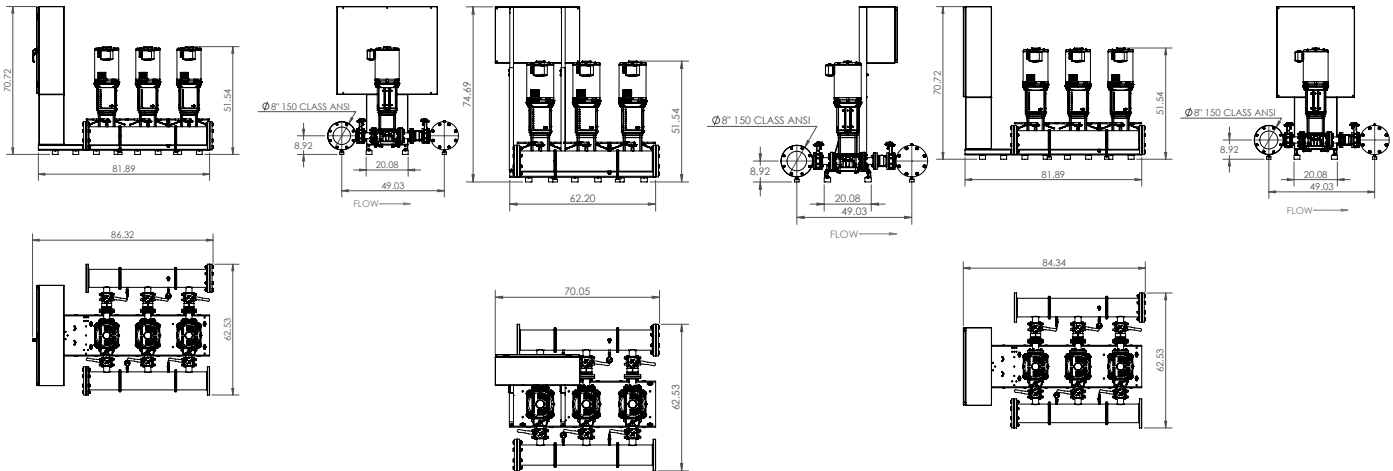

Special Note: All weights and dimensions are approximate and should not be used as exact rough-in dimensions

Dimensions and Weights

Model	Voltage (V)	H (in)	W (in)	L (in)	Dimensions-inches				Hydrunumatic Tank Valve on Manifold (Plugged)	Individual Pump Weight (lbs)	Package Weight (lbs)
					System Header Size	Suction / Discharge Pump Size (300 Class ANSI)	Gauge Tap Size	Transducer Tap Size			
CO-3 HELIX V190-03/1-1/20/VCE	208-230 V	70-3/4	86-1/3	62-1/2	8" 150 ANSI Class	2-1/2"	1/4" FNPT	1/4" FNPT	3/4" MNPT x 3/4" FNPT	383	2,177
	460 V	74-2/3	70	62-1/2							
	575 V	70-3/4	84-1/3	62-1/2							

TEFC Motor Data

Model	P2 (HP)	Phase (-)	Voltage (V)	FLA (per pump) (A)	System FLA	Pmax (PSI)
CO-3 HELIX V190-03/1-1/20/VCE	20	3	208-230/460/575	50.2-45.4/22.7/18.2	159.1/75.1/65.2	232

Submittal Data Sheet

Wilco CO-Helix - NSF 61/372 Pressure Boosting System



CO-3 HELIX V190-03-1/20/VCE



Project:	
Engineer:	
Contractor:	
Submitted By:	Date:
Approved By:	Date:

Tag #	Model #	Flow	BOOST PSI	Min. Inlet PSI	HP/Pump	Phase	Voltage	RPM
	CO-3 HELIX V190-03-1/20/VCE				20			3600

Article Number: 3327852 / 3313435 / 3313443

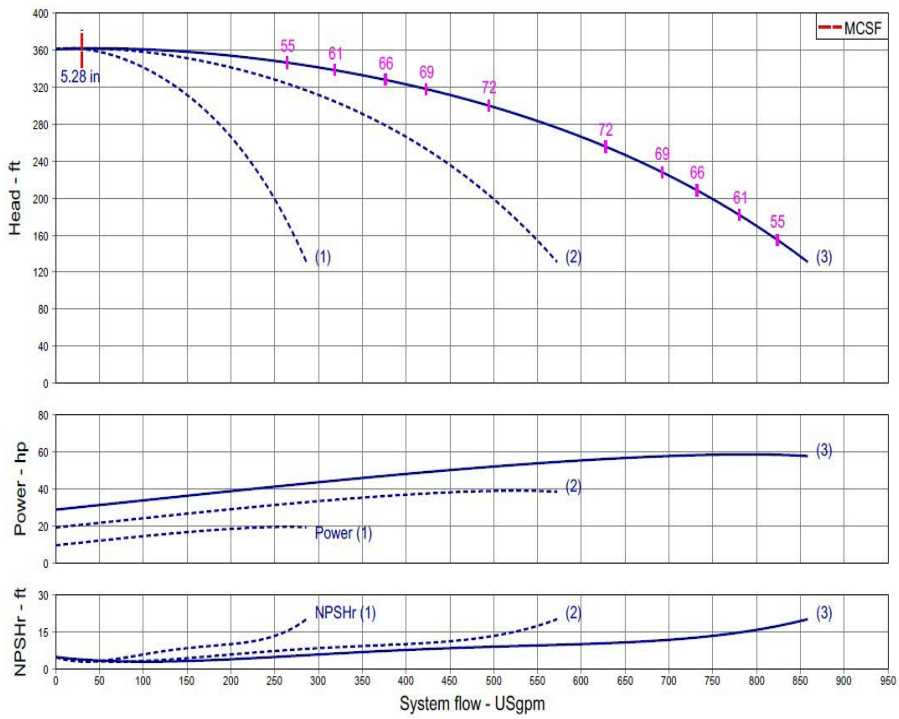

Applications

- Water Supply
- Pressure Boosting
- Agriculture
- Cooling Circuits
- Washing / Sprinkling Systems
- Condensate Return

Materials of Construction

Pump Volute	AISI304 stainless steel with ANSI flanges
Impeller	3D Laser welded AISI 304 Stainless Steel
Shaft	AISI304, AISI318 LN, or AISI431 Stainless Steel
Elastomers	EPDM
Manifolds	304 SS with 150 Class ANSI Flanges
Isolation Valves	Cast Iron Wafer Butterfly, All Stainless Steel Wetted Components
Check Valves	Cast Iron Body with All Stainless Steel Wetted Components, Spring-loaded non-slam
Mechanical Seal	Cartridge Seal: Sleeve AISI316L / Spring Clips AISI304
Pressure Transducers	316 Stainless Steel
Pressure Gauges	304 Stainless Steel Housing with 316 Stainless Steel wetted parts
System Base	Steel (S235JR)
Vibration Isolators	Neoprene, Height Adjustable

Technical Data - Operational Ranges

Liquid Temp Range	-4°F to +180°F (Min. 32 °F for Domestic Water)
Ambient Temp Range	+32°F to +104 °F
Max System Pressure	232 PSI

Technical Data - Panel

Power Supply	208-230/460-3 or 575-3
Enclosure	NEMA 12 (3R Available Upon Request)
Standard	Meets UL 508A
Variable Frequency Drives	Danfoss FC-51: • 1 to 5 HP for 208-230/460v-3 Danfoss FC-101: • 7.5 to 20HP 208-230V-3 • 1 to 10HP 208-230-1 IN / 208-230-3 OUT • 15 to 20HP 460V-3 • 1 to 20HP 575V-3

Technical Data - PLC

User Interface	7" Diagonal Color LCD Touchscreen
Display Resolution	800 x 480 Pixels
Supply Voltage	24VDC
Max. Current Consumption	320mA@24V
Number of Analog Inputs	9
Number of Analog Outputs	2
Number of Digital Inputs	18
Number of Digital Outputs	17
Onboard Communications	Modbus Protocol (Optional Gateways for BACnet, LonWorks, and CANbus)
Ethernet Port	RJ45 port capable of transmitting data 10/100Mbps
Additional Ports	2.0 USB Port; Micro-SD Port

Motor Data

Power Supply	208-230, 460, 575-3
Motor Enclosure	Totally Enclosed Fan Cooled (TEFC)
Motor Efficiency	Nema Premium Efficiency - Meets NEMA 12-12 Rule
Enclosure Construction	Rolled Steel / Cast Iron
Motor Protection Index	IP54
Insulation Class	F

Approval Stamp

Submittal Data Sheet

Wilo CO-Helix - NSF 61/372 Pressure Boosting System



CO-3 HELIX V190-03-1/20/VCE

208-230 V~3

460 V~3

575 V~3

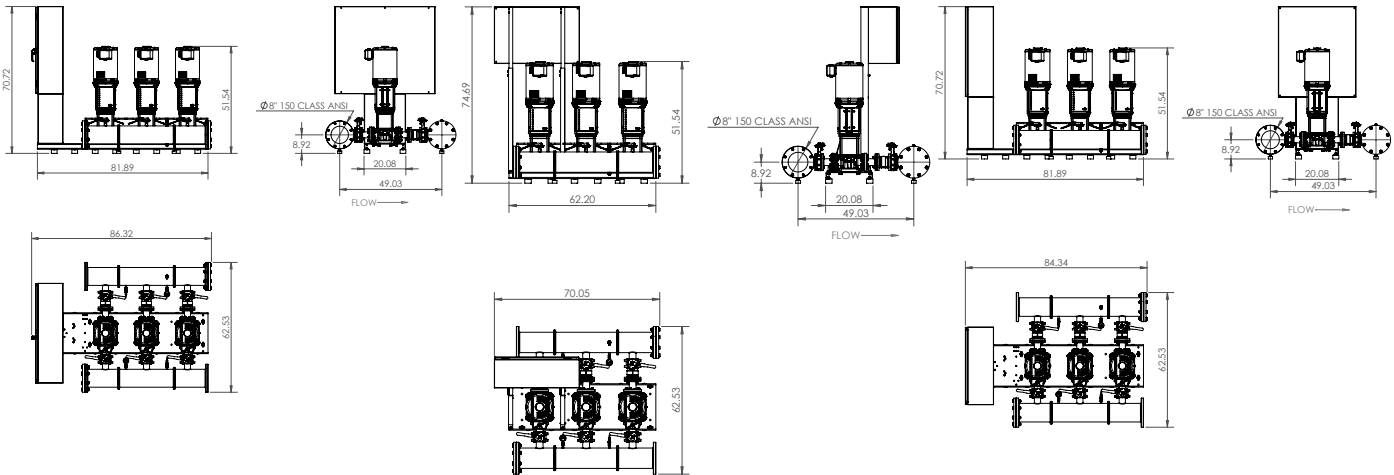

Special Note: All weights and dimensions are approximate and should not be used as exact rough-in dimensions

Dimensions and Weights

Model	Voltage (V)	H (in)	W (in)	L (in)	Dimensions-inches					Individual Pump Weight	Package Weight
					System Header Size	Suction / Discharge Pump Size (300 Class ANSI)	Gauge Tap Size	Transducer Tap Size	Hydrunumatic Tank Valve on Manifold (Plugged)	Pump Weight (lbs)	Package Weight (lbs)
CO-3 HELIX V190-03-1/20/VCE	208-230 V	70-3/4	86-1/3	62-1/2	8" 150 ANSI Class	2-1/2"	1/4" FNPT	1/4" FNPT	3/4" MNPT x 3/4" FNPT	383	2,177
	460 V	74-2/3	70	62-1/2							
	575 V	70-3/4	84-1/3	62-1/2							

TEFC Motor Data

Model	P2 (HP)	Phase (-)	Voltage (V)	FLA (per pump) (A)	System FLA	Pmax (PSI)
CO-3 HELIX V190-03-1/20/VCE	20	3	208-230/460/575	50.2-45.4/22.7/18.2	159.1/75.1/65.2	232