

## Wilo-Control SC-Fire Electric A2P



**en** Installation and operating instructions

Fig. 1

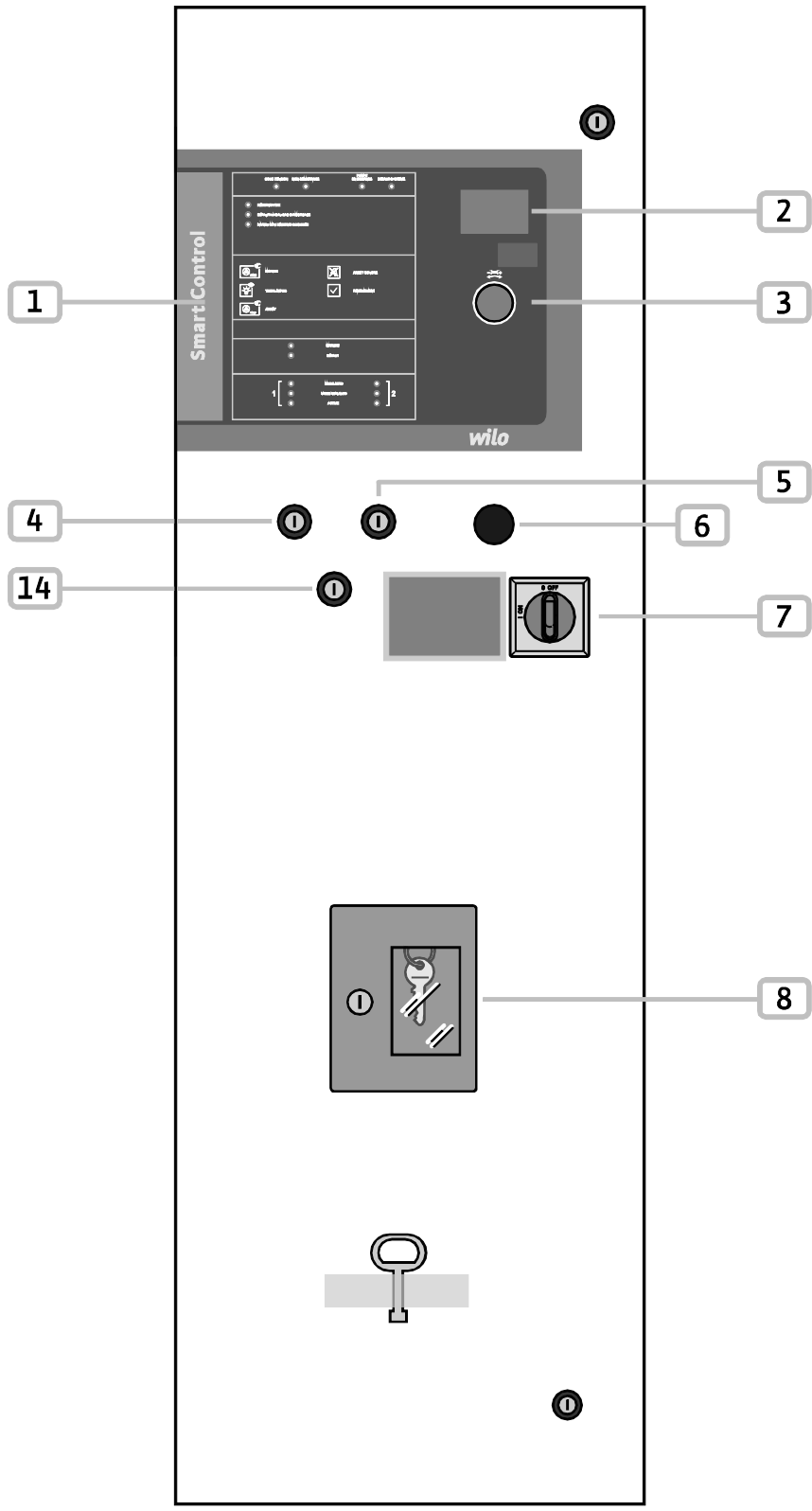

Fig. 1

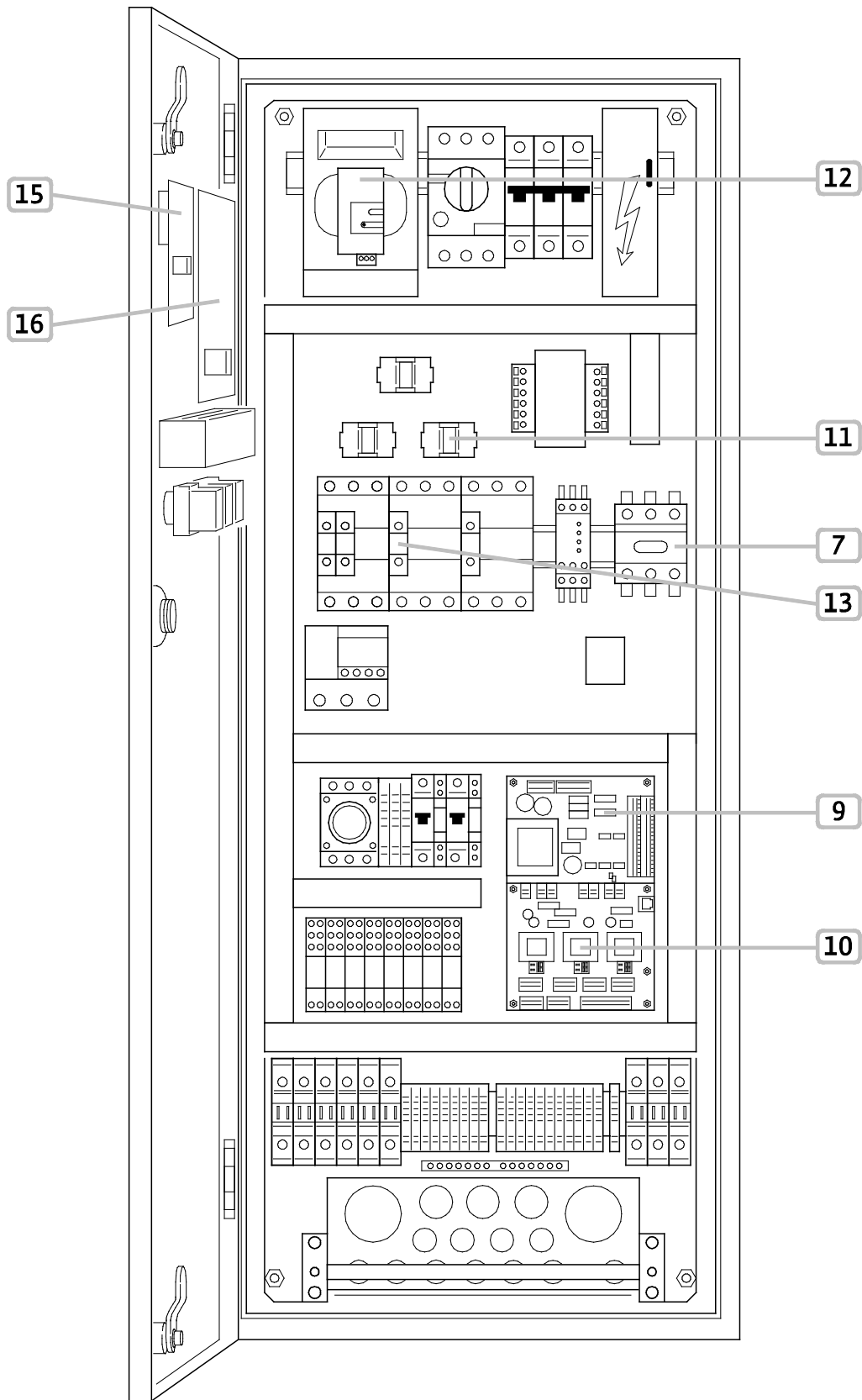
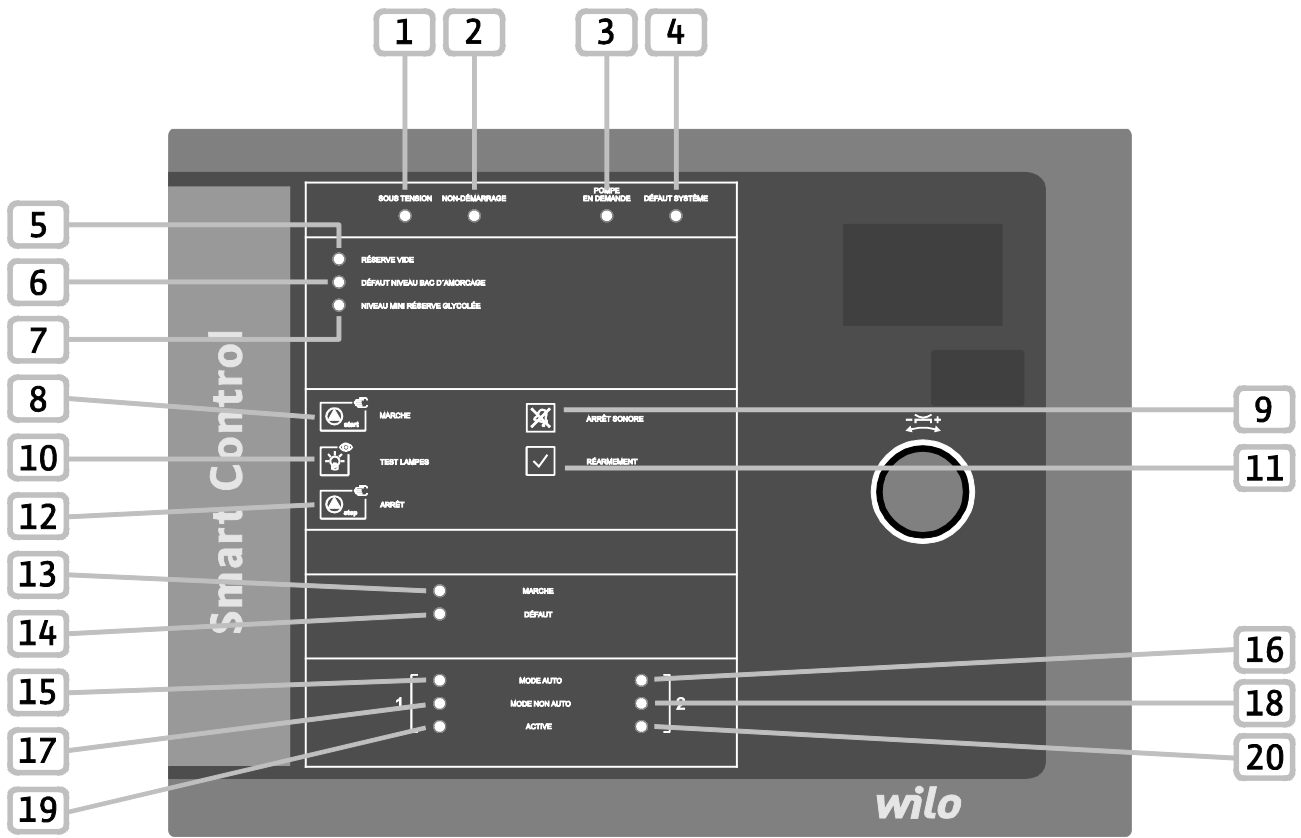

Fig. 2



# 1 General

## About this document

The language of the original installation and operating instructions is German. All other languages of these instructions are translations of the original installation and operating instructions.

The installation and operating instructions are an integral part of the product. They must be kept close to the product and be ready for use if necessary. Strict adherence to these instructions is a precondition for the proper use and correct operation of the product.

These installation and operating instructions correspond to the relevant version of the product and the underlying safety standards valid at the time of going to print.

## EC declaration of conformity:

A copy of the EC declaration of conformity is a key component of these installation and operating instructions. If a technical modification is made on the designs listed therein without prior approval or the declarations made in the installation and operating instructions on product/personnel safety are not observed, this declaration loses its validity.

# 2 Safety

These installation and operating instructions contain important information which must be adhered to during installation, operation and maintenance. For this reason, these instructions must, without fail, be read by the service technician and the responsible specialist/operator before installation and commissioning.

It is not only the general safety instructions listed under the main point "safety" that must be adhered to but also the special safety instructions with danger symbols included under the following main points.

## 2.1 Symbols and signal words used in the installation and operating instructions

### Symbols:



### Signal words:

#### **DANGER!**

**Acutely dangerous situation.**

**Non-observance results in death or the most serious of injuries.**

#### **WARNING!**

**The user may suffer (serious) injuries. "Warning" implies that (serious) injury to persons is probable if this information is disregarded.**

#### **CAUTION!**

**There is a risk of damaging the pump/system. "Caution" implies that damage to the product is likely if this information is disregarded.**

**NOTE:**

Useful information on handling the product. It draws attention to possible problems.

**2.2 Personnel qualifications**

The installation, operating and maintenance personnel must have the appropriate qualifications for this work. Area of responsibility, terms of reference and monitoring of the personnel are to be ensured by the operator. If the personnel are not in possession of the necessary knowledge, they are to be trained and instructed. This can be accomplished if necessary by the manufacturer of the product at the request of the operator.

**2.3 Danger in the event of non-observance of the safety instructions**

Non-observance of the safety instructions can result in risk of injury to persons and damage to the environment and the product/unit. It also results in the loss of any claims to damages.

In detail, non-observance can, for example, result in the following risks:

- Danger to persons due to electrical, mechanical and bacteriological influences.
- Damage to the environment due to leakage of hazardous materials.
- Property damage.
- Failure of important product/unit functions.
- Failure of required maintenance and repair procedures.

**2.4 Safety instructions for the operator**

This device is not intended for use by persons (including children) with reduced physical, sensory or mental capabilities, or lack of experience and knowledge, unless they have been given supervision or instruction concerning use of the appliance by a person responsible for their safety.

Children should be supervised to ensure that they do not play with the device.

- If the product/unit poses a threat due to components being too hot or too cold, these components must be protected by the customer against touching.
- Guards which protect personnel from coming into contact with moving components (e.g. the coupling) must not be removed while the product is in operation.
- Hazardous fluids (e.g. from the shaft seals) which have leaked (which are explosive, toxic or hot) must be eliminated so that no danger to persons or to the environment arises. National statutory provisions are to be complied with.
- Highly flammable materials are always to be kept at a safe distance from the product.
- Danger from electrical current must be eliminated. Local directives or general directives [e.g. IEC, VDE etc.] and instructions from energy supply companies must be adhered to.

**2.5 Safety instructions for installation and inspection work**

The operator must ensure that all maintenance and installation work is carried out by authorised and qualified personnel, who are sufficiently informed based on their own detailed study of the installation and operating instructions.

Work on the product/unit must only be carried out when at a standstill. It is mandatory that the procedure described in the installation and operating instructions for shutting down the product/unit be complied with. Immediately on conclusion of the work, all safety and protective devices must be put back in position and/or recommissioned.

## 2.6 Unauthorised modification and manufacture of spare parts

Unauthorised modification and manufacture of spare parts will impair the safety of the product/personnel and will make void the manufacturer's declarations regarding safety.

Product modifications are exclusively authorised following the agreement of the manufacturer. Original spare parts and accessories authorised by the manufacturer ensure safety. The use of other parts will absolve the company of liability.

## 2.7 Improper use

The operating safety of the supplied product is only guaranteed for conventional use in accordance with Section 4 of the installation and operating instructions. The limit values must on no account fall under or exceed those values specified in the catalogue/data sheet.

## 3 Transport and interim storage

Upon receipt of the product:

- Check for any damage that may have occurred during transit.
- In the event of damage in transit take the necessary steps within the period defined by the transport company within the time constraints.



**CAUTION! Risk of property damage!**

- **The switchgear must be protected against humidity and any mechanical damage.**
- **The product must not be exposed to temperatures lower than -10 °C and higher than +50 °C.**

## 4 Applications (application)

The switchgear SC Fire A2P controls a single electric pump in automatic sprinkler systems in accordance with APSAD (T1-2).

The relevant fields of application are habitable buildings, offices, hospitals, hotels, administrative and industrial buildings.

The pump is switched according to the pressure or level when it is used with the right signal sensors.

Compliance with this manual is also part of correct use.

Any use which does not meet this criteria is considered to be non-compliant.

## 5 Product information

### 5.1 Type key

Example: W-CTRL-SC-F-1x(2)A-T4-(3)-(4)-ND-E		
W	Multiple choice	<u>Brand:</u> W: Wilo
CTRL	Fixed	Operation
SC	Fixed	Smart Control = control unit
F	Fixed	F = application of protection against fire
1x	Fixed	Number of pumps
(2)	Multiple choice	<u>Maximum rated current of the motor [A]:</u> 14.1A 20.4A 27.6A 33.7A 39.1A 53.6A 65.8A 78.0A 95.0A 129.0A
T4	Fixed	T = three-phase ; 4 = 400 V
(3)	Multiple choice	<u>On state:</u> DOL: Direct online (direct starting) SD: Star Delta (start star-delta)
(4)	Multiple choice	<u>Type of installation of switchbox:</u> FM: Frame mounted (placed on a baseplate) BM: Base mounted (mounted on feet)
ND	Fixed	Switchgear type "New Design"
E	Fixed	Switchgear for electric pump

Table 1 – Type key



## 5.2 Technical data

Technical data	
Mains connection voltage [V]:	3~ 400 V (L1, L2, L3, PE)
Frequency [Hz]:	50/60 Hz
Control voltage [V]:	230 V AC ; 24 V AC/DC
Absorbed current max [A]:	See the rating plate
Protection class:	IP44
Fuse protection max on mains side [A]:	See circuit diagram
Room temperature [°C]:	0 °C to +50 °C
Electrical safety:	Pollution degree II
Alarm/signal contact:	250 V AC, 1 A

Table 2 – Technical data

## 5.3 Scope of delivery

- Switchgear
- Circuit diagram
- Installation and operating instructions
- Check log in accordance with EN 60204-1

## 5.4 Accessories

# 6 Description and function

## 6.1 Product description

### 6.1.1 Function description

The switchgear is used to control a single electric pump in “sprinkler systems” in accordance with APSAD (T1-2).

In automatic mode the pump is switched on according to the unit pressure. Each pump has 2 pressure switches at its pressure connection to monitor the pressure. Each pressure switch is controlled by a key switch.

When the pump is started, it can only be switched off manually and only when the pressure has been reached in the unit.

In manual mode the start of the pump is activated from the HMI.

The start-up of the pump is done by means of a start-up tank, the filling of which is controlled by a float switch.

States of system operation such as availability, pump operation, malfunctions, etc. are visually indicated by LEDs on the front of the switchbox and equally by a buzzer. Operating parameters such as current or voltage values are displayed on the screen. The operation is performed by means of the rotary knob, key switches and buttons accessible on the front of the switchbox.

Potential-free contacts are available for transmitting the collective run or malfunction signals to a possible BMS (building management system).

### 6.1.2 Structure of the switchgear (Fig. 1)

The installation of components in the switchbox depends on the performance of the pump connected.

The switchgear includes the following main components:

- Main on/off switch: Power supply of the switchgear (pos. 7)
- Human-machine interface (HMI): signal lamps or screen for displaying the state of operation (for example availability, malfunction and rated current of the pump), user test of the pump and function allowing error messages to be acknowledged (pos. 1, 2, 3)
- Key switch: selection of operating mode (manual, deactivation, automatic) of the pressure switches (pos. 4, 5)
- Change-over switch (pos. 14): access to level 2
- Buzzer signal: additional buzzer for certain error messages (pos. 6)
- “SC controller” PCB: printed circuit board with microcontroller (pos. 9)  
Warning: There are 2 “SC controller” PCBs, fixed with spacer sleeves to superimpose them.
- “SC U/I” PCB: Measurement/acquisition voltage/current (pos. 10)
- Current converter: pump current measurement (pos. 11)
- Fuse protection: protection of the pump motor (pos. 12)
- Contactor: Contactor of the motor of the pump (pos. 13)
- “SC Display” PCB: printed circuit board with display and rotary button (pos. 14)
- “SC I/O” PCB: printed circuit board with control/operating console (pos. 15)
- Key box: enables the storage of the keys from the key switches (pos. 8)

## 6.2 Function and operation



**DANGER! Risk of death!**

**When working on an open switchgear, there is a risk of electrocution in the event of contact with active conductors.**

**This work must only be carried out by qualified personnel!**



After connecting the switchgear to the connection voltage as well as after each network cut-off, the switchgear reverts to the operating mode set before the voltage cut-off.

### 6.2.1 Switchgear operating modes of the start/deactivation

After connection to the power supply, the switchgear can be switched on or off using the main switch. Once the main switch has been activated, the system is instantly ready for operation. After several seconds, the green signal lamp (Fig. 2, pos. 1) lights up.

## Operating mode

You can define the operating mode of the switchgear by selecting one of the three positions of the key switch “Auto”, “0” or “Manual”.

Starting the motor with...		Key switch 1		
		AUTO	OFF	MANUAL
Key switch 2	AUTO	Pressure switch 1 Pressure switch 2 Float switch	Pressure switch 2 Float switch	“ON” button Pressure switch 2 Float switch
	OFF	Pressure switch 1  Float switch	-	“ON” button
	MANUAL	Pressure switch 1 “ON” button Float switch	“ON” button	“ON” button

**Table 3: Operating modes**

### Automatic mode

The key switch (Fig. 1, pos. 4, 5) is placed in the “Auto” position, the “Auto” position is thus confirmed by the corresponding green LEDs (Fig. 2, pos. 15, 16).

The unit starts up automatically once the pressure switch no. 1 opens and the key switch no. 1 is in the “Auto” position or once the pressure switch no. 2 activates and the key switch no. 2 is in the “Auto” position.

Any open pressure switch is signalled by a green LED for pressure switch 1 or a yellow LED for the pressure switch 2 (Fig. 2, pos. 19, 20). Triggering of the float switch (low level of start-up tank) starts the pump if at least one of the 2 key switches is in the “Auto” position.

### Non-automatic mode

This mode is activated when the key switches are not in the “Auto” position.

This operating mode is signalled by the red LEDs (Fig. 2, pos. 17, 18).

Furthermore, the output “NON-AUTO MODE 1/2” is activated.

### Manual mode

To perform a manual start-up, place one of the key switches in the “Man” position. The manual start button “ON” (Fig. 2, pos. 8) enables start-up of the pump.

### Deactivation mode

To switch off the pump, at least one of the key switches must be in the “0” position.

As soon as the pressure switch or the float switch is no longer activated, the pump can be switched off by means of the “OFF” button (Fig. 2, pos. 12).

### Pump start-up

In auto mode, if the pressure measured by at least one of the two pressure switches is below the switch-on threshold, the LED/LEDs (“active” Fig. 2, pos. 19 and pos. 20) turn/s on green for pressure switch 1 or yellow for pressure switch 2. Once the follow-up time has elapsed (see menu 1.2.5.1) the pump starts.

Note: If the follow-up time (menu 1.2.5.1) is quite long, it is possible to see the LED flashing while the follow-up time elapses.

The LED (“on” Fig. 2, pos. 13) turns on green and signals the operation of the pump. Throughout pump operation, the instantaneous current of the pump is monitored and displayed on the screen. When a malfunction arises, and even if the pump continues to function, the error code of the malfunction is displayed for 30 seconds.

Once the set pressure is reached or exceeded it is possible to switch off the LED/LEDs (“active” Fig. 2, pos. 19 and pos. 20) previously turned on by pressing the malfunction acknowledgement. The pump is still running and must be switched off manually.

### **Start-up tank**

If the level of water in the start-up tank of the pump is less than 2/3 of the full level, the float switch closes and the red indicator light is activated (Fig. 2, pos. 6). Following a configurable follow-up time (see menu 1.2.5.2) the pump switches on and the green indicator light (Fig. 2, pos. 13) is activated.

Note: As the follow-up time expires, the indicator light flashes

As soon as the tank is full, the float switch opens and the error message can be acknowledged. The indicator light turns off (Fig. 2, pos. 6) and the pump can be switched off manually. The audible warning (Fig. 2, pos. 13) deactivates also.

### **Control of the voltage**

To increase operational safety, the power supply voltage of the switchbox is subject to permanent control. The power supply voltage is configured in the menu 1.2.1.1 (400 V by default), the 3 phases are controlled. When the pump is on standby, the 3 phase-to-phase voltages are displayed one after another.

As soon as the power supply voltage is lower or higher than the defined tolerance level (see menus 5.4.1.0 and 5.4.2.0), an error code is displayed after a certain time lag (see menu 1.2.5.3).

When the pump is in operation, and in case of a malfunction, the pump continues to function.

### **Protection against excess currents**

During pump functioning, the current is subject to permanent monitoring.

The rated current motor is configurable in the menu 1.2.1.2.

The current is monitored over the three phases. When the pump is functioning, the current is indicated on the screen. The green indicator light (“on” Fig. 2, pos. 13) turns on as soon as the current of the pump reaches a predefined minimum level (see menu 5.4.3.0).

As soon as the current of the pump exceeds the maximum threshold (see menu 5.4.4.0), the red indicator light (“malfunction” see menu 1.2.5.5) (Fig. 2, pos. 14) turns on.

Despite the presence of an error, this does not prevent the pump from starting or continuing to function. As soon as the current level of the pump returns to within the range of the levels permitted, you can acknowledge the error. And the indicator light (Fig. 2, pos. 14) deactivates.

### **Monitoring of the “pump in demand”**

As soon as the pump switches on, a pressure switch located at the pressure connection monitors whether the pressure at the pump outlet is correct.

After a certain predefined time (see menu 1.2.2.2), if the pressure at the pump outlet is not reached, the red indicator light turns on (“pump in demand” Fig. 2, pos. 3).

When the pressure exceeds the configured threshold, the error message can be acknowledged and the indicator light will change to green (Fig. 2, pos. 3).

### **Monitoring of failed start-up**

When the pump is in operation, and after a certain predefined time in the menu 1.2.2.1, the electrical power consumption is monitored.

The power is monitored against the following parameterisation: 1.2.1.1 and 1.2.1.2.

During the monitoring period, and after a certain configured lag time (see menu 1.2.5.6), if the minimum value has not been reached (see menu 5.4.5.0), the indicator light will turn yellow (Fig. 2, pos. 2).

When the power consumed is reached again, the error message can be acknowledged. And the indicator light will change from yellow to green (Fig. 2, pos. 2).

## 6.2.2 Application of the switchgear

### Operation elements

#### Levels of access

- **The level of access 1** allows access to the function test of the lamp (Fig. 2, pos. 2) without intervention in addition.
- **The level of access 2** is performed using a key switch (Fig. 1, pos. 7) and enables access to the reset function in the event of error messages (Fig. 2, pos. 4).
- **The level of access 3** is performed using a ciphered code encoded in the menu 7.0.0.0, enabling access to all menu items.





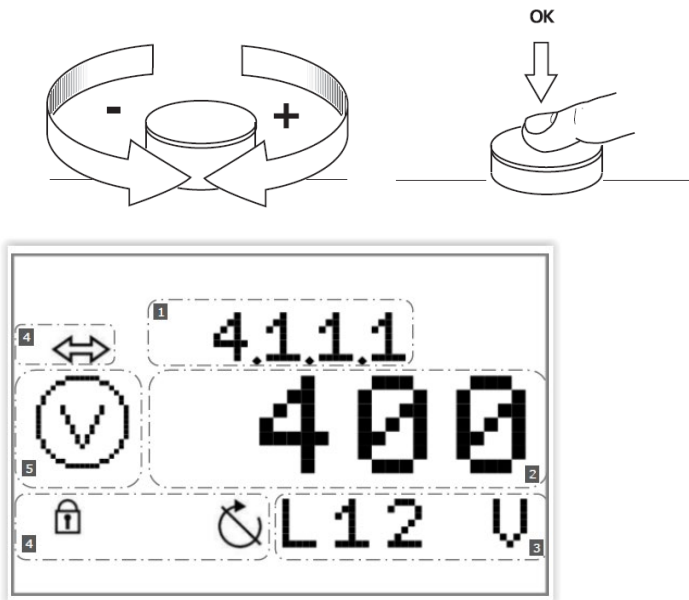



#### Functions and application elements



















- **Main switch** On/Off (lockable in “Off” position) (Fig. 1, pos. 7)
- **LCD screen** (Fig. 1, pos. 2) The LCD screen displays the pump operating status and the settings menu. Thanks to the **control button** (Fig. 1, pos. 3) you can select the menus and enter the parameters (level 3 access required). To alter the values and scroll through the menu levels, turn the function. To select and confirm your input, press the button:













Pos.	Description
1	Menu number
2	Value display
3	Unit display
4	Standard symbols
5	Graphic symbols











The following graphic symbols are used:

Symbol	Function/description
	Brief press: Return to the previous menu Long press: Return to the main screen
	EXPERT menu
	1. Notification: service not connected 2. Notification: display value – no entry possible
	Unlocked
	Service menu
	Parameters
	Information
	Malfunction
	Reset malfunction

	Alarm settings
	Pump
	Setpoint
	Actual value
	Sensor signal
	Measurement range sensor
	Follow-up time
	Operating mode/application
	Stand-by
	Operational data
	Switchgear data: Controller type; ID number; software/firmware
	Operating hours
	Pump operating hours
	Switchgear operating test runs
	Pump operating test runs
	Communication
	Output parameters
	SSM parameters

	Sprinkler (pressure switch)
	Pump filling tank (float switch)
	Activation failed
	Pressure
	Power supply (mains)
	Voltmeter
	Ammeter
	Cut-in star-delta
	Malfunction signal freely configurable
	Malfunction input



	Duration
	Power indicator
	Communication parameters
	Modbus
	BACnet
	Factory setting
	Reset to the factory setting
	Alarm counter
	Maintenance interval
	Reset

**Menu structure:**

The menu structure of the control system is organised into 4 levels.



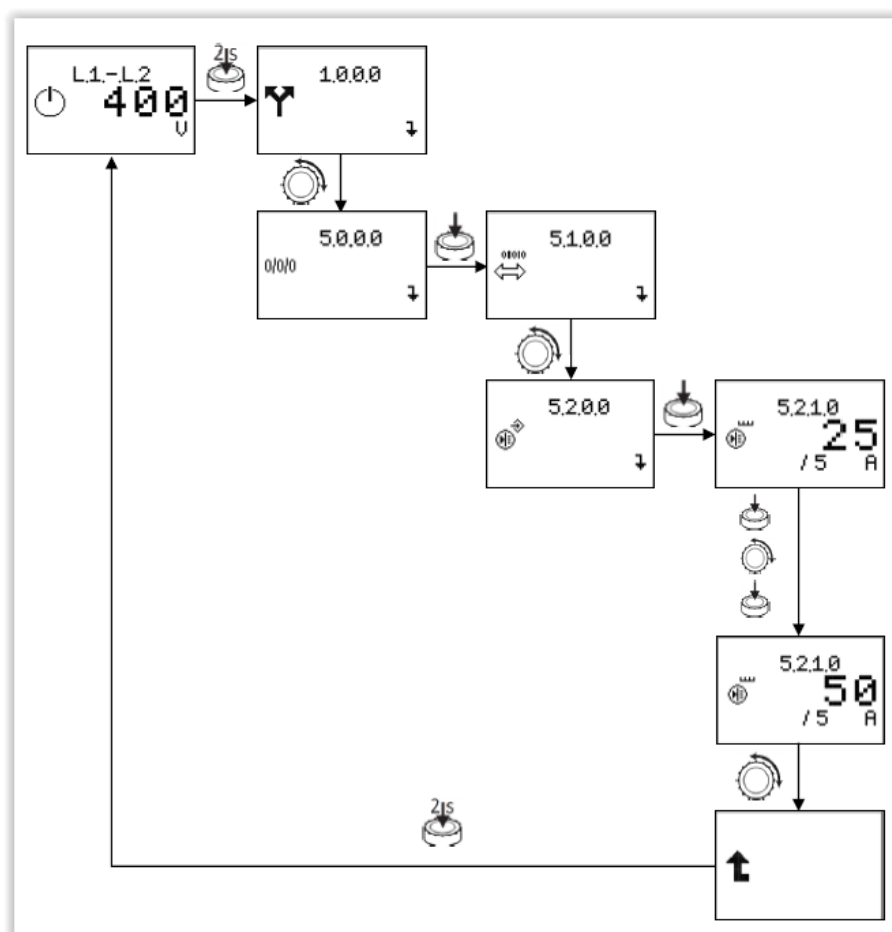

Navigation in the individual menus as well as the parameter input are described in the example below – selection of transformers (level 3 required):





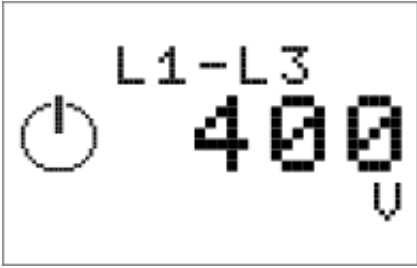

Refer to the following table for a description of the individual menu items.



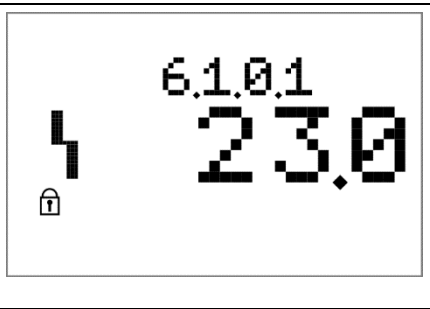

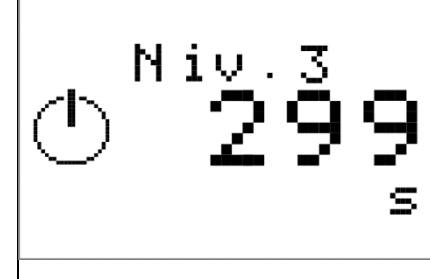

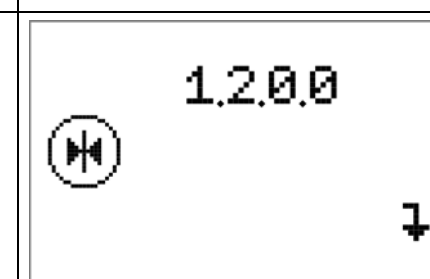
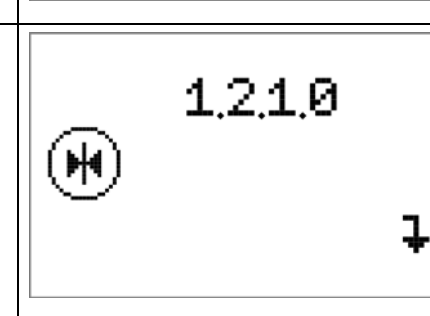
No. menu/	1.1.1.1 Screen	1.1.2 Description	Parameter range Factory setting
-----------	----------------	-------------------	------------------------------------

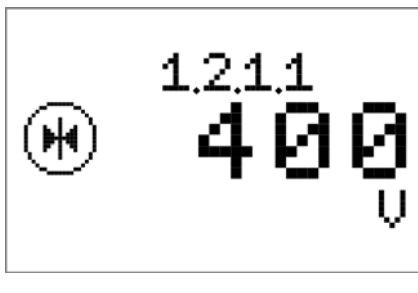
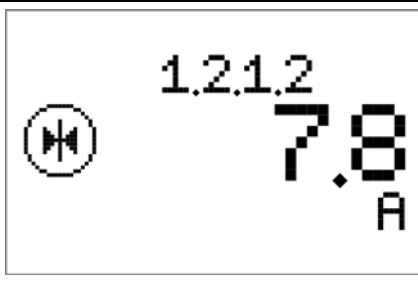
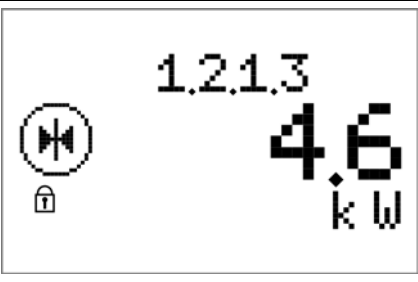
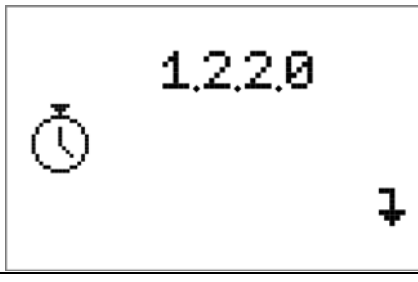
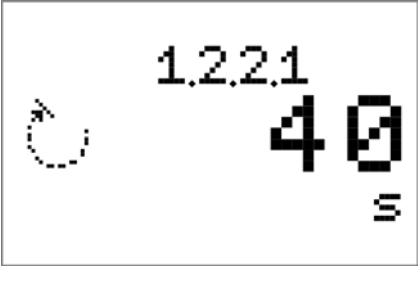
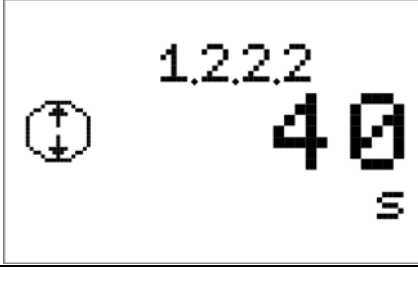

Menu accessible from the level of access 1



		<p>The main screen indicates the status of the unit. The display constantly switches from one voltage to another (alternating between L1-L2, L1-L3 and L2-L3).</p>	
		<p>When the pump is in operation, the instantaneous current on the three phases and the voltages are displayed in turns on the screen.</p>	
		<p>"Services" menu</p>	
		<p>To access level 3 an access code must be entered. After 5 minutes of inactivity on HMI or after a main supply malfunction, access is blocked and the code must be re-entered.</p>	0...9999
		<p>"Malfunctions" menu</p>	

6.1.0.1 to 6.1.1.6		History memory of malfunctions from 1 to 16  Note: The history memory of malfunctions and the error counter can be reset via menu 7.5.9.9, accessible on level 3.	
Menu accessible from the level of access 3			
		Menu unlocked after entering the access code.	
		The remaining time [in seconds] before deactivation of the level of access 3 in case of inactivity on the HMI is also indicated on the main screen.	
		The EXPERT menu contains other settings which enable a detailed configuration of the switchgear.	
		Access to the parameter menu enabling modification of the system operation	
		Access to the settings menu of the electrical parameters of the pump	

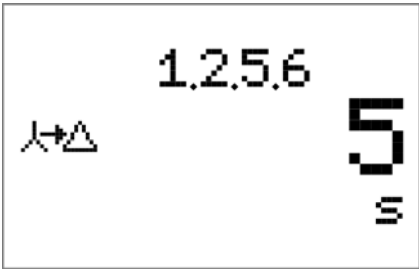
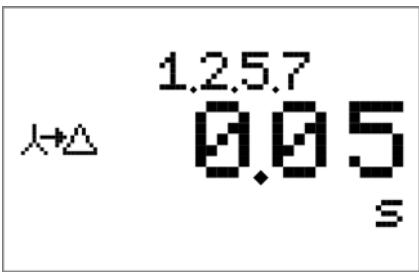
	 <p>1.2.1.1 400 U</p>	Adjustment of the connection voltage	<b>400</b>
	 <p>1.2.1.2 7.8 A</p>	Adjustment of the rated current of the pump	0.1.. <b>7.8</b> ..500.0
	 <p>1.2.1.3 4.6 kW</p>	Display of the motor power of the pump	
	 <p>1.2.2.0 ↓</p>	The parameter menu for all timer parameters influencing the operation	
	 <p>1.2.2.1 40 s</p>	Adjustment of the follow-up time for the monitoring of the electrical power of the pump (electrical error at start-up)	0.. <b>40</b> ..120
	 <p>1.2.2.2 40 s</p>	Adjustment of the follow-up time for the monitoring of the pressure at the pump outlet (error "pump in demand")	0.. <b>5</b> ..120

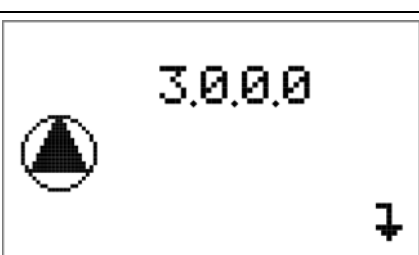
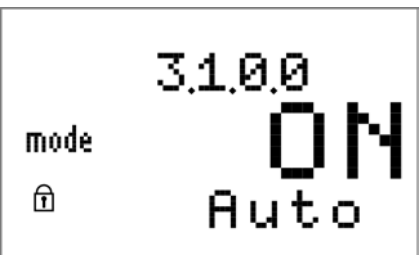



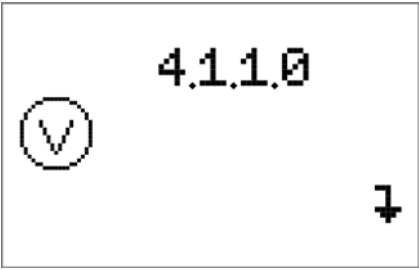
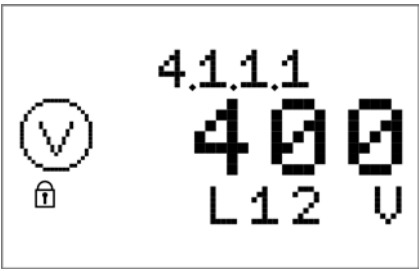
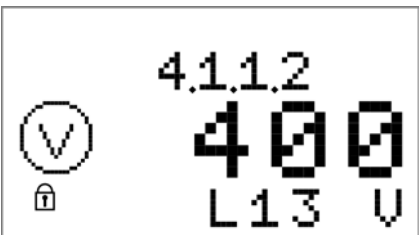
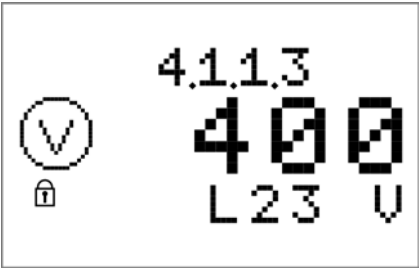



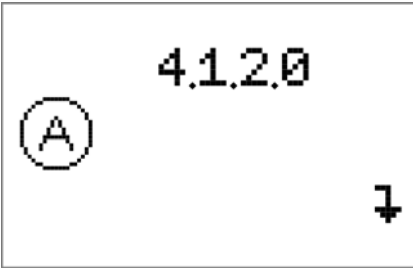
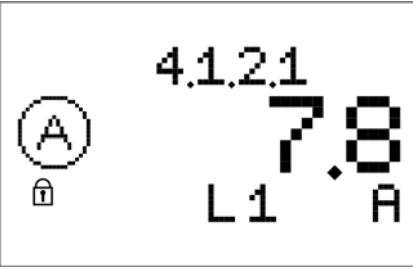
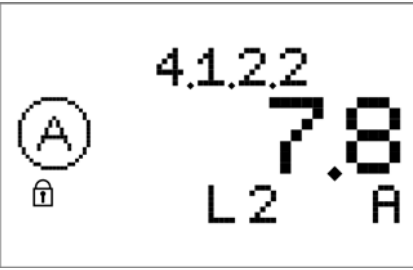
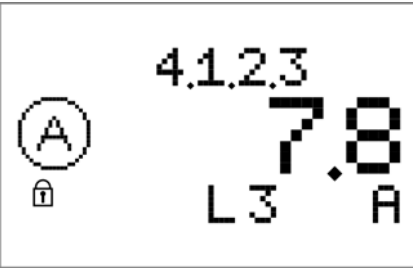
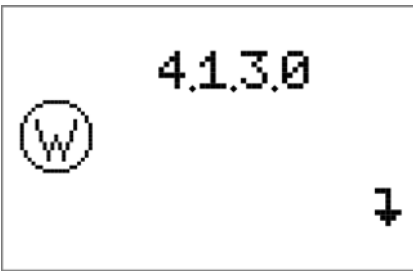
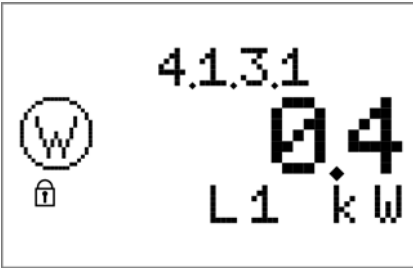

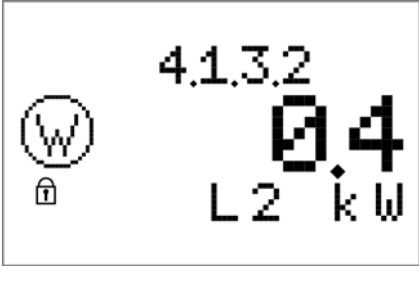
	 <p style="text-align: center;">1.2.5.0</p> 	The settings menu for the follow-up times and delays	
	 <p style="text-align: center;">1.2.5.1</p> <p style="text-align: right;"><b>1</b> s</p>	Start-up delay of the pump upon activation of the pressure switch	<b>1..120</b>
	 <p style="text-align: center;">1.2.5.2</p> <p style="text-align: right;"><b>1</b> s</p>	Start-up delay upon activation of the float switch	<b>1..120</b>
	 <p style="text-align: center;">1.2.5.3</p> <p style="text-align: right;"><b>1</b> s</p>	Follow-up time of the error message for the monitoring of the voltage	<b>0..1..10</b>
	 <p style="text-align: center;">1.2.5.4</p> <p style="text-align: right;"><b>10</b> s</p>	Follow-up time of the error message "electrical error at start-up"	<b>5..10..20</b>
	 <p style="text-align: center;">1.2.5.5</p> <p style="text-align: right;"><b>10</b> s</p>	Follow-up time in the event of error message through current monitoring	<b>5..10..20</b>

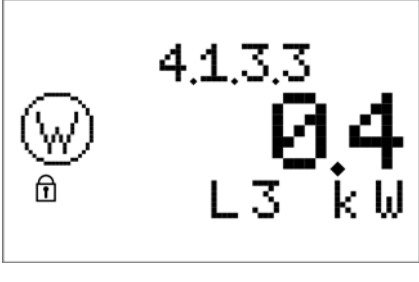
No. menu/	1.1.1.1 Screen	1.1.2 Description	Parameter range Factory setting
		Cut-in time star-delta	0..5..60
		Buffer time between the activation of the star contactor and the interlocking of the delta contactor	0.00..0.05..1.0
		Communication	
		Display of the field bus temporarily activated	<b>Number bus</b> , Modbus, BACnet
		Pump menu	
		Display of the automatic mode of operation: ON or OFF	

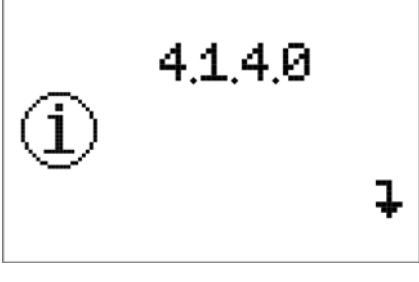

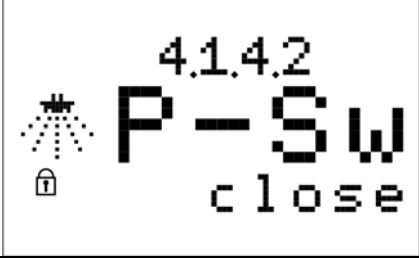

<b>No. menu/</b>	1.1.1.1 Screen	<b>1.1.2 Description</b>	<b>Parameter range Factory setting</b>
		Information	
		Present operation values	
		Voltage values	
		Voltage display between conductors L1 and L2	
		Voltage display between conductors L1 and L3	
		Voltage display between conductors L2 and L3	

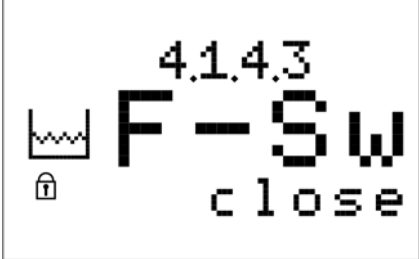
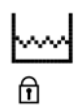

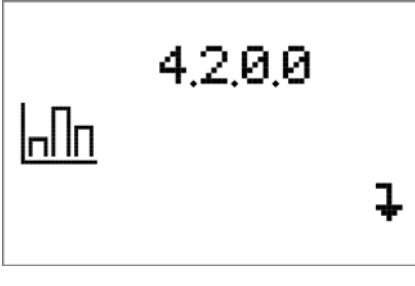
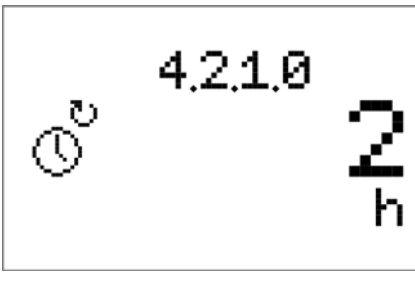
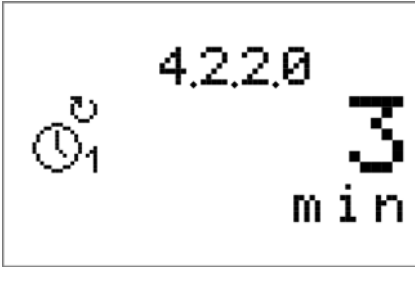
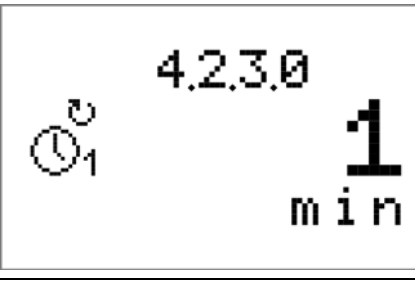
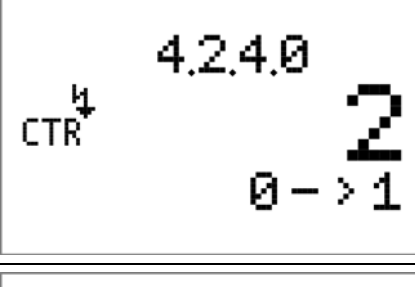
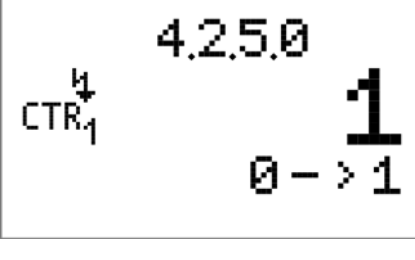

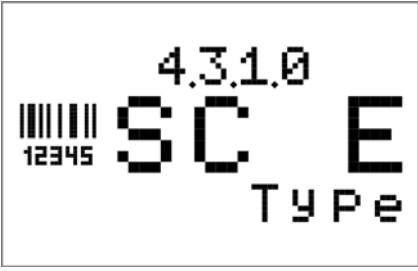
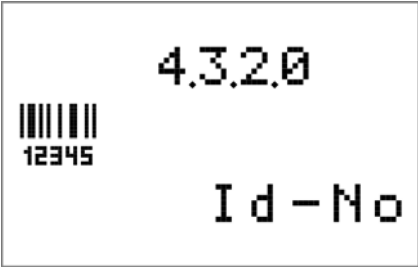

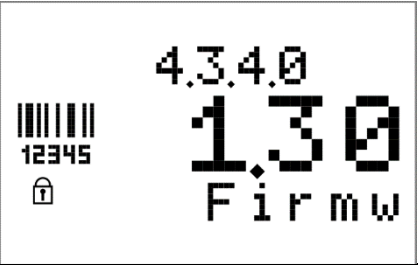

No. menu/	1.1.1.1 Screen	1.1.2 Description	Parameter range Factory setting
		Current values	
		Current display of pump in L1	
		Current display of pump in L2	
		Current display of pump in L3	
		Performance values	
		Performance display L1	

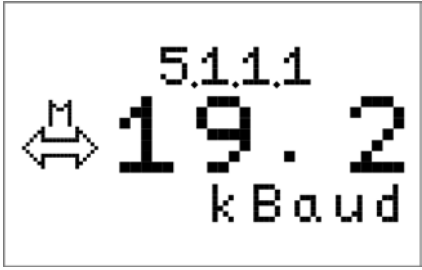

No. menu/	1.1.1.1 Screen	1.1.2 Description	Parameter range Factory setting
	 <p>4.1.3.2    0.4  L2 kW</p>	Performance display L2	
	 <p>4.1.3.3    0.4  L3 kW</p>	Performance display L3	
	 <p>4.1.4.0    ↓</p>	Status information	
	 <p>4.1.4.1    Sys  ready</p>	Display of the status of the system/availability	
	 <p>4.1.4.2    P-Sw  close</p>	Display of the status of the pressure switches	
	 <p>4.1.4.3    F-Sw  close</p>	Display of the status of the float switch	

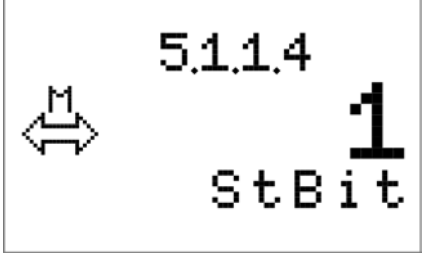

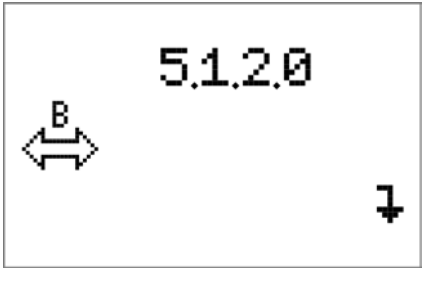
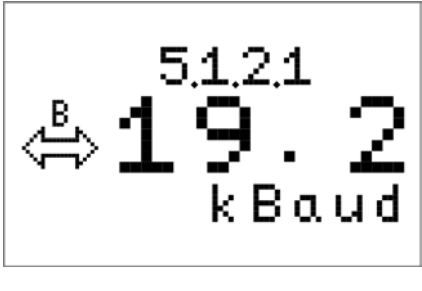
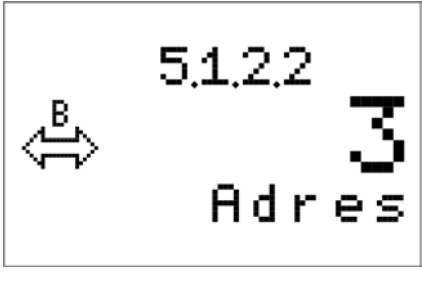
No. menu/	1.1.1.1 Screen	1.1.2 Description	Parameter range Factory setting
		Operational data	
		Total hour counter of operation of the switchbox SC-FIRE Electric	
		Total hour counter of operation of the pump	
		Total hour counter of operation of the pump <u>since the last start-up</u>	
		Number counter of power-ups of the switchbox SC-FIRE electric Note: Activation of the main switch	
		Number counter of pump start-ups	

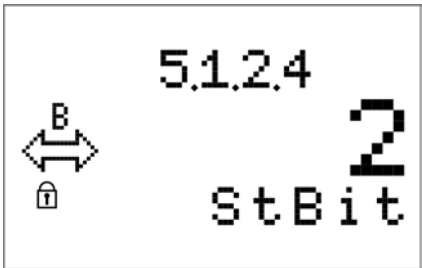
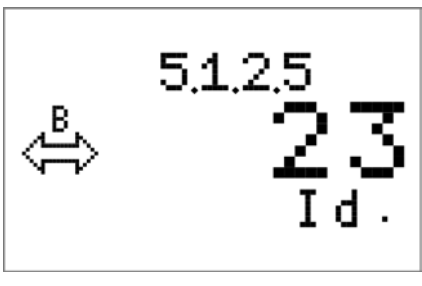
No. menu/	1.1.1.1 Screen	1.1.2 Description	Parameter range Factory setting
	 <p>4.3.0.0 12345 ↓</p>	Unit characteristics	
	 <p>4.3.1.0 12345 SC E Type</p>	Type of switchbox	
	 <p>4.3.2.0 12345 Id-No</p>	Serial number display Note: Text scrolling	
	 <p>4.3.3.0 12345 4.103 Softw</p>	Software version	
	 <p>4.3.4.0 12345 1.30 Firmw</p>	Firmware version	
	 <p>5.0.0.0 0/0/0 ↓</p>	Adjustments	

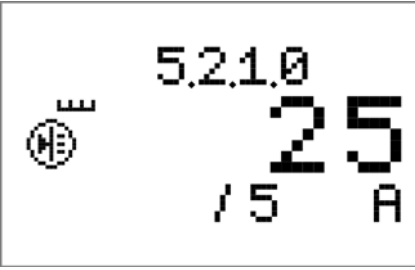

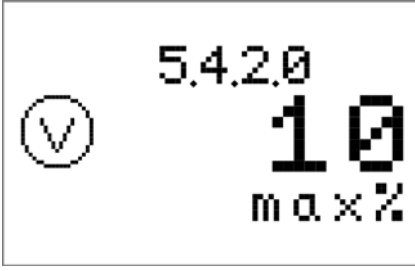

No. menu/	1.1.1.1 Screen	1.1.2 Description	Parameter range Factory setting
		Communication	
		Modbus	
		Baud delivery rate	9.6 <b>19.2</b> 38.4 76.8
		Slave address	1..4...247
		Parity	<b>even</b> not odd
		Stop bits	<b>1</b> 2

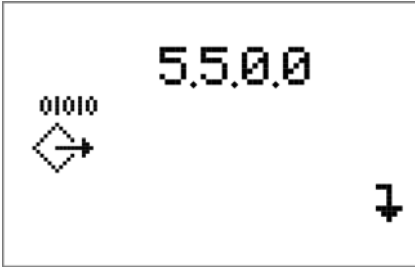
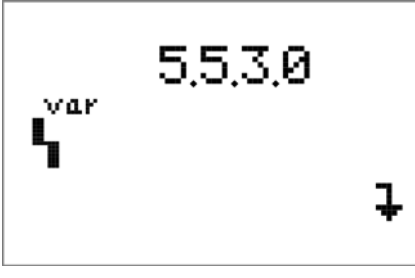
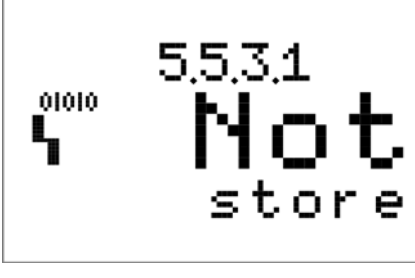



No. menu/	1.1.1.1 Screen	1.1.2 Description	Parameter range Factory setting
	 <p>5.1.2.0</p>	BACnet	
	 <p>5.1.2.1</p> <p>19.2 kBaud</p>	Baud delivery rate	9.6 <b>19.2</b> 38.4 76.8
	 <p>5.1.2.2</p> <p>3 Adres</p>	Slave address	1... <b>128</b> ...255
	 <p>5.1.2.3</p> <p>none Parit</p>	Parity	even <b>not</b> odd
	 <p>5.1.2.4</p> <p>2 StBit</p>	Stop bits	<b>1</b> 2
	 <p>5.1.2.5</p> <p>23 Id.</p>	BACnet Device Instance ID	0... <b>128</b> ...9999

No. menu/	1.1.1.1 Screen	1.1.2 Description	Parameter range Factory setting
		Adjustments of the sensors	
		Selection current transformer	25..1000
		Limit values	
		Lower tolerance limit of the connection voltage	0..10..20
		Higher tolerance limit of the connection voltage	0..10..20

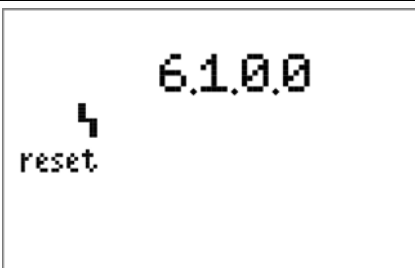

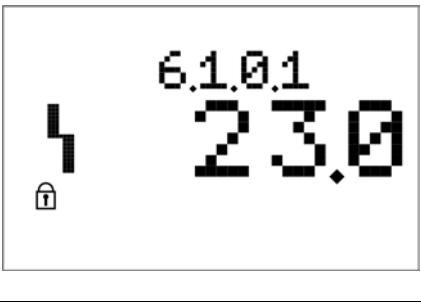
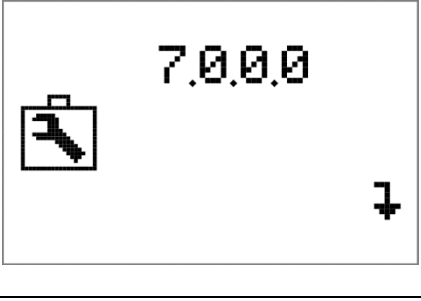

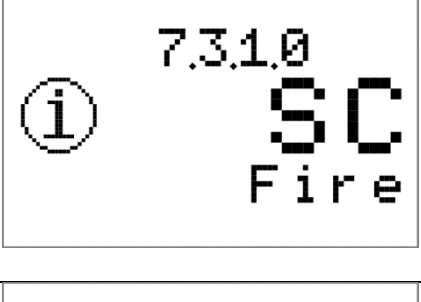
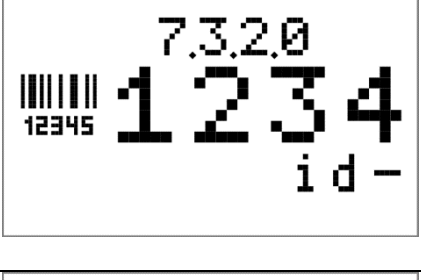



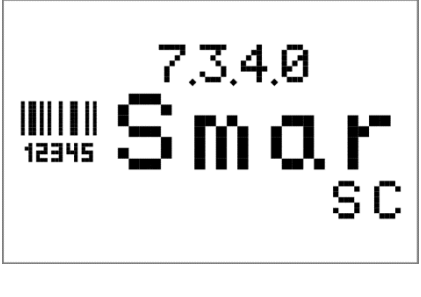
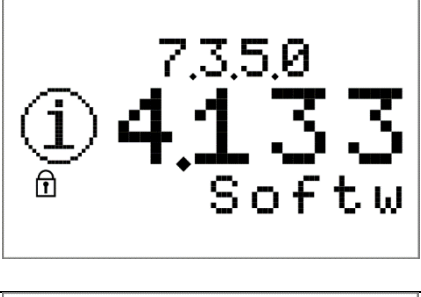
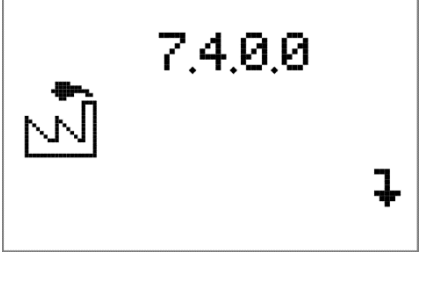
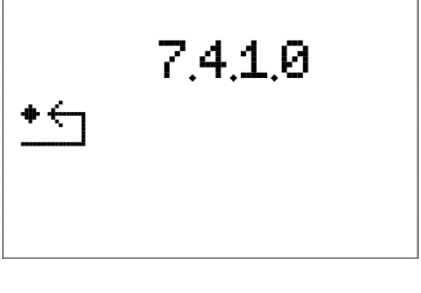
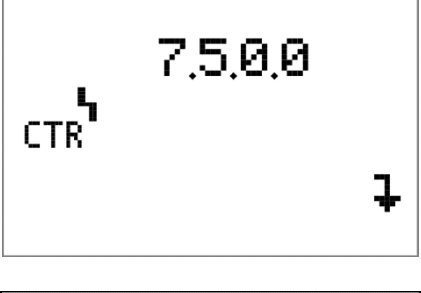
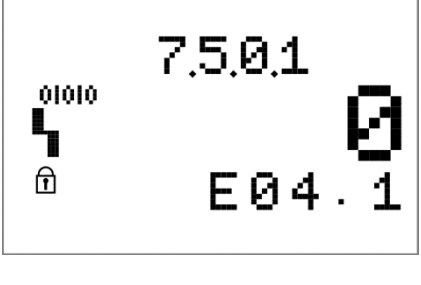

No. menu/	1.1.1.1 Screen	1.1.2 Description	Parameter range Factory setting
		Lower tolerance limit of the rated current of the pump	0.. <b>10</b> ..100
		Higher tolerance limit of the rated current of the pump	0.. <b>10</b> ..100
		Adjustment for minimum performance of detection of the start of the pump	0.. <b>50</b> ..100
		Output parameters	
		Malfunction signal freely configurable	
		Acknowledgement behaviour for malfunction messages	<b>Not store</b> , ON store





No. menu/	1.1.1.1 Screen	1.1.2 Description	Parameter range Factory setting
		Logic reversal signal of input	Fall, <b>Raise</b>
		Activation malfunction messages to configure	<b>OFF</b> , ON
		Malfunction active: Always or Only with pump in operation	Ever, <b>Pump</b>
		Response delay	<b>0..60</b>
		Malfunction messages	
		Resetting of malfunction messages	

6.1.0.1 to 6.1.1.6		Malfunction messages 1 to 16	
		Service menu	
		Access to the parameterisation of the cabinet	
		Designation of the cabinet	
		<p>Adjustment of the serial number: Adjustment of the first 4 numbers of the serial number</p> <p>These numbers are adjusted in the factory and cannot be modified.</p>	0...9999
		<p>Adjustment of the serial number: Adjustment of the last 4 numbers of the serial number</p> <p>These numbers are adjusted in the factory and cannot be modified.</p>	0...9999

	 <p>7.3.4.0 Smart SC</p>	Controller designation	
	 <p>7.3.5.0 4.133 Softw</p>	Software version display	
	 <p>7.4.0.0</p>	Factory setting menu: Possibility to reset the cabinet to factory configuration	
	 <p>7.4.1.0</p>	Restoring of factory parameters: By pressing the red button, the symbol "factory" flashes, turn the red button to the right, the symbol "reverse arrow" appears, press the button a second time to launch the resetting of the cabinet to factory configuration.	
	 <p>7.5.0.0 CTR</p>	Alarm menu	
	 <p>7.5.0.1 E04.1</p>	Error counter display, showing the number of times that the error Exx.x has occurred. Scroll through the error codes with the red button.	

	 <p>7.5.9.9</p>	<p>Resetting of the malfunction history and error counter: By pressing the red button, the symbol flashes, turn the red button on the right side, press the button a second time.</p> <p>The malfunction history and the error counter are now reset.</p>	
	 <p>7.6.0.0</p> 	<p>Additional menu functions</p>	
	 <p>7.6.1.0</p>  <p>Key</p>	<p>Activation code: Enter the activation code, for example, to activate a field bus connection.</p>	
	 <p>7.6.2.0</p>  <p>Access</p>	<p>Modification of access code to level 3: To reset the access code, please call the technical service.</p>	
	 <p>7.7.0.0</p> 	<p>Operational data of the menu reset</p>	
	 <p>7.7.1.0</p>	<p>Resetting to zero of the total hour counter of pump operation time and start-up number counter: By pressing the red button, the symbol flashes, then press the button a second time.</p>	

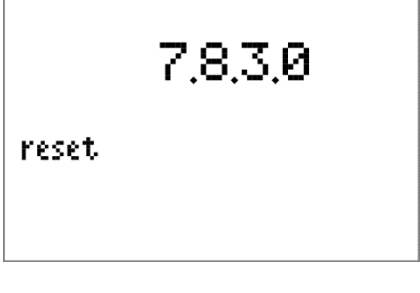
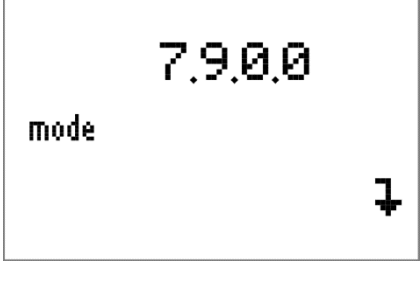
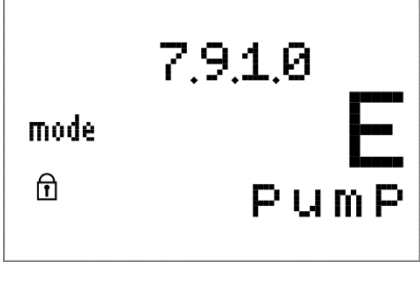
	 <p>7.8.0.0 ↴</p>	Maintenance and repair menu	
	 <p>7.8.1.0 OFF Time</p>	Activation/deactivation of the maintenance interval OFF Or ON	
	 <p>7.8.2.0 92 d</p>	Adjustment of the duration in days for the maintenance interval	0... <b>92</b> ...1000
	 <p>7.8.3.0 reset</p>	Resetting to zero of the maintenance message: By pressing the red button, it is possible to reset the maintenance countdown.	
	 <p>7.9.0.0 mode ↴</p>	Application menu	
	 <p>7.9.1.0 mode E PUMP</p>	Diesel mode display	

## Description of cabinet components:

- **Key switches** (Fig. 1, pos. 4 and 5)  
Pressure switch no. 1 and pressure switch no. 2 each have a key switch.  
  
The 3 positions available are: Auto / Off / Manual.  
The keys can only be withdrawn if the key switches are in the “Auto” position. Once the “0” or “Manual” position has been selected, it is not possible to launch an automatic start-up of the pump, even if the pressure switch or the float switch are active.  
The status corresponding to the “Auto” position is signalled by the green LEDs (Fig. 2, pos. 15, 16) and that which corresponds to the “0” or “Manual” position by the red LEDs (Fig. 2, pos. 17, 18).
- **Key change-over switch** (Fig. 1, pos. 14)  
Enables access to the functions of level of access 2.
- **“ON”** (Fig. 2, pos. 8)  
By pressing this button, the pump starts manually. To do this, at least one of the two key switches must be in the “Manual” position. Pump operation is signalled by the green signal lamp (Fig. 2, pos. 13). The pump must be switched off manually and the signal lamp (Fig. 2, pos. 13) turns off also.
- **“BUZZER OFF”** (Fig. 2, pos. 9)  
This button (level 1) allows an audible signal emitted in case of alarm to be cleared separately. As soon as a new malfunction arises, the buzzer signal sounds once again.
- **“OFF”** (Fig. 2, pos. 12)  
By pressing this button, the pump switches off manually. To do this, at least one of the two key switches must be in the “0” position and neither the pressure switch nor the float switch must be activated. The pump can only be switched off with this button.
- **“LAMP TEST”** (Fig. 2, pos. 10)  
By pressing this button (level 1), all the signal lamps (Fig. 2, pos. 1 to 20) and the buzzer activate and remain activated while the button is pressed down. This allows for the control of correct operation of all of the LEDs. Once the button is released, the signal lamps and the alarm buzzer turn off or remain turned on if the functioning demands it.
- **“RESET”** (Fig. 2, pos. 11)  
By pressing this button (level 2 required), all the error messages/signal lamps are reset insofar as the cause of the error has been eliminated.

### 6.2.3 Display elements of the switchgear

#### “LIVE”

The signal lamp (Fig. 2, pos. 1) turns on green if the power supply is established and if it has been activated with the main on/off switch.

#### “ON”

The signal lamp (Fig. 2, pos. 13) turns on green if the pump is running and the current consumed by the pump motor falls within the tolerance limits set (see menu 5.4.3.0).

**“START-UP FAILURE”**

When the pump is running, the power consumed by the pump is permanently monitored.

At pump start-up and after a set follow-up time (see menu 1.2.2.1), if the power consumed by the pump is below the threshold set (see menu 5.4.5.0), the LED (Fig. 2, pos. 2) turns on.

**“PUMP IN DEMAND”**

As soon as the pump is operating and the matching pressure switch does not close after a defined period (see menu 1.2.2.2), the signal lamp (Fig. 2, pos. 3) lights up red.

**“SYSTEM MALFUNCTION”**

The yellow signal lamp (Fig. 2, pos. 4) signals a software malfunction if the communication between the control board and the display board is disrupted and the software routine can no longer take place.

**“TANK EMPTY”**

If the water tank level is too low, the LED (Fig. 2, pos. 5) turns on red.

**“START-UP TANK LEVEL MALFUNCTION”**

The signal lamp (Fig. 2, pos. 6) turns on red as soon as the level of the pump start-up tank falls below 2/3 and when the float switch is triggered. If at least one key switch is in the “Auto” position, the pump starts automatically. If the level rises sufficiently, the signal lamp (Fig. 2, pos. 6) turns off again. The pump must be switched off manually.

**“LEVEL MINI GLYCOL TANK”**

If the glycol tank level is too low, the LED (Fig. 2, pos. 7) turns on red.

If the malfunction occurs when the pump is in operation the pump continues to function.

You can acknowledge the error message and the indicator light (Fig. 2, pos. 7) when the level of the glycol tank is once again above the low level.

**“MALFUNCTION”**

A signal lamp (Fig. 2, pos. 14) turns on red:

- upon activation of the pump protection device,
- if the thermistor of the motor is triggered,
- if the fuse switch amplifier is open,
- if the fuses have been triggered,
- if a phase sequence malfunction occurs,
- or if a malfunction is detected at the control voltage.

**“AUTO MODE”**

The signal lamp (Fig. 2, pos. 15/16) is turned on green if the matching key switch is in the “Auto” position. In the automatic mode, the automatic start-up of the pump is possible either via the intermediary of the float switch or the corresponding pressure switch.

**“NON-AUTO MODE”**

The signal lamp (Fig. 2, pos. 17/18) is turned on red if the matching key switch is in the “0” or “Manual” position. In the non-automatic mode, no automatic start-up of the pump is possible via the intermediary of the float switch or the corresponding pressure switch.

**“ACTIVE”**

When the pressure in the unit falls below the threshold set on the pressure switches, the pressure switch(es) becomes active. The LED flashes green (for pressure switch 1) or yellow (for pressure switch 2).

After the elapsed follow-up time (menu 1.2.5.1), the LED remains turned on permanently.

If key switch 1 or 2 is in the “Auto” position, the pump starts automatically.

When the pressure rises and exceeds the threshold set, the pressure switch passes to the passive state. It is possible to turn off the LED by pressing the acknowledgement button (Fig. 2, pos. 11).

The acknowledgement is only accessible if the user has previously connected to level 2.

## 7 Installation and electrical connection

**Installation and electrical connection must be carried out in accordance with local regulations and only by qualified personnel!**



**WARNING! Risk of personal injury!**  
Comply with applicable accident prevention regulations.



**Warning! Risk of electric shock!**  
Danger from electrical current must be eliminated.  
Local directives or general directives [e.g. IEC] and instructions from local energy supply companies must be adhered to.

### 7.1 Installation

Install the switchgear/unit in a dry location.

Protect the place of installation from direct exposure to sunlight.

### 7.2 Electrical connection



**DANGER! Risk of death!**  
In case of non-compliant electrical connection, there is a danger of death by electrocution.

- Have the electrical connection established by an electrician approved by the local energy supply company only and in accordance with local regulations.
- Observe the installation and operating instructions for the pumps and accessories.
- Disconnect the power supply before any work!



**Warning! Risk of electric shock!**  
There is a potentially fatal voltage on the supply side, even when the main switch is turned off.



- The power supply configuration, current type and the mains connection voltage must be in accordance with the indications given on the rating plate of the device.

**NOTE:**

- Fuse on mains side in accordance with the information in the wiring diagram.
- Feed the ends of the mains cable through the threaded cable connections and cable inputs and wire them according to the markings on the terminal strips.
- Earth the pump/system in accordance with the regulations.

**NOTE:**

In accordance with the standard EN/IEC 61000-3-11 (see the following table), the switchgear and a pump of a performance of ... kW (column 1) are planned to be used within a power supply network of an impedance system of  $Z_{max}$  at the particular connection of. ... Ohm max (column 2) for a maximum number of ... connections (column 3).

If the mains impedance and the number of connections per hour are higher than the values shown in the table, the switchgear related to the pump can, in the presence of unfavourable network conditions, lead to temporary decreases in voltage as well as disruptive variations in voltage ("flickers").

It may require the implementation of measures before the switchgear and the pump can function in a compliant way regarding this connection. Contact the local electrical energy supply company and the manufacturer to obtain the necessary information.

	<b>Performance [kW] (Column 1)</b>	<b>System impedance [<math>\Omega</math>] (Column 2)</b>	<b>Connections per hour (Column 3)</b>
Three-phase 400 V 2 poles Direct starting	2.2	0.257	12
	2.2	0.212	18
	2.2	0.186	24
	2.2	0.167	30
	3.0	0.204	6
	3.0	0.148	12
	3.0	0.122	18
	3.0	0.107	24
	4.0	0.130	6
	4.0	0.094	12
	4.0	0.077	18
	5.5	0.115	6
	5.5	0.083	12
	5.5	0.069	18
	7.5	0.059	6
	7.5	0.042	12
	9.0 – 11.0	0.037	6
	9.0 – 11.0	0.027	12
	15.0	0.024	6
	15.0	0.017	12
Three-phase 400 V 2 poles Starting S-D	5.5	0.252	18
	5.5	0.220	24
	5.5	0.198	30
	7.5	0.217	6
	7.5	0.157	12
	7.5	0.130	18
	7.5	0.113	24
	9.0 – 11.0	0.136	6
	9.0 – 11.0	0.098	12
	9.0 – 11.0	0.081	18
	9.0 – 11.0	0.071	24
	15.0	0.087	6
	15.0	0.063	12
	15.0	0.052	18
	15.0	0.045	24
	18.5	0.059	6
	18.5	0.043	12
	18.5	0.035	18
	22.0	0.046	6
	22.0	0.033	12
22.0	0.027	18	

### 7.2.1 Power supply connection

The 4-wire cable (L1, L2, L3, PE) provided by the customer for the power supply network must be connected to the main switch in accordance with the wiring diagram.

### 7.2.2 Connection of the malfunction/operating messages

On the terminal strip on the lower part of the switchbox, potential-free contacts are available to allow a possible malfunction/operating information message (see diagram).

Potential-free contacts, contact load max. 250 V ~/1 A

#### “ALARM LACKS VOLTAGE”

Activation of the output upon onset of one of the following malfunctions:

- Loss of connection voltage
- Malfunction of phase sequence
- Main on/off switch open
- Activation failed
- System malfunction

#### “MALFUNCTION”

Activation of the output upon onset of one of the following malfunctions:

- Overload
- Pump protection fuse holder open
- Pump protection fuse holder activated
- Pressure too low during pump operation (malfunction pump in demand)

#### “NON-AUTO MODE 1”

The output is activated if the corresponding key switch 1 is in the “0” or “Manual” position. In the non-automatic mode, no automatic start-up of the pump is possible via the intermediary of the float switch or the corresponding pressure switch.

#### “NON-AUTO MODE 2”

The output is activated if the corresponding key switch 2 is in the “0” or “Manual” position. In the non-automatic mode, no automatic start-up of the pump is possible via the intermediary of the float switch or the corresponding pressure switch.

#### “ON”

The output is activated if the pump starts and the pump current falls within the tolerance limits set (see menu 5.4.3.0).

#### “START-UP TANK LEVEL MALFUNCTION”

The output is activated when the level of the pump start-up tank is below 2/3 and when the float switch is triggered.

#### “TANK EMPTY”

If the level of the water tank is too low, the output is activated.

**“LEVEL MINI GLYCOL TANK”**

If the level of the glycol tank is too low, the output is activated.

**Error message freely configurable**

The message output is activated according to the corresponding input signal and the configuration of malfunctions in the menu.

	Colour of the LED	Buzzer	“ MALFUNCTION”	“ ALARM LACKS VOLTAGE”	“ NON-AUTO MODE 1/2”	“ ON”	“ START-UP TANK LEVEL	“ TANK EMPTY”	“ LEVEL MINI GLYCOL TANK”
“LIVE”	green								
“START-UP FAILURE”	yellow	x		x					
“PUMP IN DEMAND”	red	x	x						
“SYSTEM MALFUNCTION”	yellow	x		x					
“TANK EMPTY”	red	x						x	
“START-UP TANK LEVEL MALFUNCTION”	red	x					x		
“LEVEL MINI GLYCOL TANK”	red	x							x
“ON”	green					x			
Undervoltage “MALFUNCTION”	red	x		x					
Control voltage error “MALFUNCTION”	red	x		x					
Excess current pump “MALFUNCTION”	red	x	x						
Fault pump “MALFUNCTION”	red	x	x						
“AUTO MODE 1/2”	green								
“NON-AUTO MODE 1/2”	red				x				
“ACTIVE 1/2”	green/yellow								

Table 4: Malfunction signals and run signals



**Warning! Risk of electric shock!**  
There is a potentially fatal voltage on these terminals,  
even when the main switch is turned off.

## 8 Commissioning



**WARNING! Risk of death!**  
**Commissioning by qualified personnel only!**  
**Improper commissioning poses a risk of fatal injury.**  
**Have commissioning performed by qualified personnel only.**



**DANGER! Risk of death!**  
**When working on an open switchgear, there is a risk of electrocution in the event of contact with conductor components.**  
**This work must only be carried out by qualified personnel!**

We recommend that you have the switchgear commissioned by Wilo customer service.

Before switching on for the first time, the wiring provided by the customer, especially the earth, must be subjected to a detailed control.



**Tighten all connection terminals prior to commissioning!**

### 8.1 Adjustments to the switchgear

Once the main on/off switch is turned on and the start sequence of the screen and the signal lamps has elapsed, the switchgear is ready to operate and displays the adjustments performed in the factory.

The factory setting can be restored by Wilo customer service.

To ensure correct operation it is necessary to proceed to the following adjustments in the menu:

- Menu 1.2.1.1: Adjustment of the connection voltage in volts.
- Menu 1.2.1.2: Adjustment of the rated current of the pump. The rated current of the pump is indicated on the rating plate of the pump.
- Menu 5.2.1.0: Adjustment of the type of current transformer (primary field of measurement of the current). The type of current transformer is indicated on the rating plate of the current transformer.

NOTE:



If the measurement line which passes into the current transformer is coiled, the current value of the transformer is to be halved for each wrapping.

Example:

A measurement line has been wrapped twice around a 100/5 A transformer.

2 circuits → transformer 25/5 A

Therefore, a current transformer 25/5 A must be indicated in the menu.

#### **Menu 3.1.0.0:**

Displaying the operating mode



If “Auto off” is set, it is not possible to launch the automatic mode. The pump can only be switched on manually.

## 8.2 Checking the motor direction of rotation

Briefly activate the pump to verify whether the direction of rotation of the pump is correct. When switching off the pump motor, compare the direction of rotation of the fan wheel and the direction specified on the pump housing.

If the direction of rotation of the pump is wrong, swap over any two phases of the mains connection.

## 9 Maintenance

**Have maintenance and repair work carried out by qualified skilled personnel only!**



**DANGER! Risk of death!**

**There is a risk of fatal injury from electric shock when working on electrical devices.**

- **The switchgear should be electrically isolated and secured against unauthorised switch-on during any maintenance or repair work.**
  - **Any damage to the connection cable should only ever be eradicated by a qualified electrician.**
- 
- The switchgear must remain clean.
  - Visual inspection of the electrical components of the system in the switchgear.

## 10 Faults, causes and remedies



### **DANGER! Risk of death!**

There is a risk of fatal injury from electric shock when working on electrical devices. Have faults remedied by qualified skilled personnel only! Follow the safety instructions under chapter 2.

Before performing any work to remedy malfunctions, disconnect the device from the power supply, and make sure it cannot be switched back on by unauthorised persons.

### 10.1 Fault indication

When a fault is observed, the corresponding LED fault indicator turns on, the contact of the corresponding fault signal is activated and the fault is displayed on the LCD (fault code number). An additional buzzer sounds for certain faults. This alarm can be switched off with the button "BUZZER OFF" (Fig. 2, pos. 9).

It is possible to clear the fault by pushing the button "RESET" (Fig. 2, pos. 11) (level 2 required) or by following the steps described in the menu 6.1.0.0 (level 3 required):

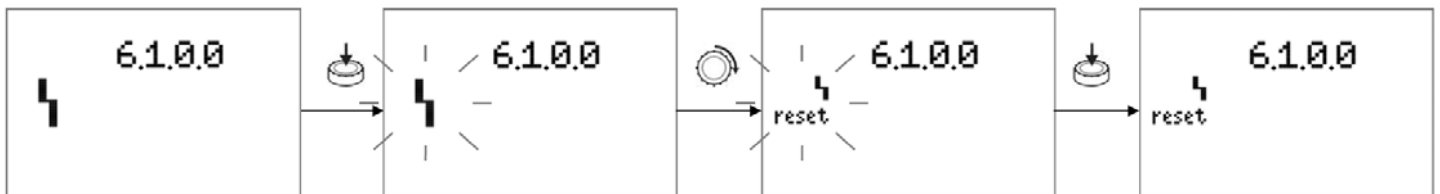

### 10.2 Fault history

The fault history works according to the FIFO (First In First Out) principal and it allows the consultation of the previous 16 arising faults.

The fault history can be consulted using menus 6.1.0.1 to 6.1.1.6 (level of access 1).

Code	Fault	Causes	Remedies
E54.0	No bus communication with the HMI PCB	Connection with the HMI PCB interrupted	Check connection
			Request customer service
E54.5	No bus communication with the slave control board	Connection with the slave control board interrupted	Check connection
		Software integrity error	Request customer service
E4.0	Undervoltage	Connection voltage on mains side too low	Check the connection voltage/network voltage, verify the fuses

E5.0	Overvoltage	Connection voltage on mains side too high	Check the connection voltage/power supply
E61.0	Pump in demand (Hydraulic error at start)	The pressure switch of the signal pump signals a lack of pressure while the pump is in operation	Check the pump/the impeller, check for leakages in the core, check the direction of rotation of the pump, adjust the pressure switch
E62.0	Low water level	Level below minimum filling level in the storage tank	Filling the storage tank
		Leakage	Check the impermeability of the storage tank and of the core
E62.1	Lack of glycol	Level below minimum filling level in the glycol tank	Filling the glycol tank
		Leakage	Check the impermeability of the glycol tank and of the core
E80.1	Pump fuse malfunction	Fuse switch amplifier open, defective fuse	Close the fuse switch amplifier, replace the defective fuse
E11.0	Electric false start	The minimum electrical performance of the motor has not been reached following the starting of the pump	Check the settings, check the pump/the impeller
E23.0	Excess current	Rated current of the pump too high during operation	The pump is blocked or impeded, check the connection voltage
E25.0	Undercurrent	Rated current of the pump too low during operation	Check the settings, check the pump/the impeller
E106.0	Malfunction operation fuse	Control board defective	Check the control board
		Replace the defective fuse of operation	Reactivate the fuse
E109.0	Error freely configurable	Depends on the configuration of the error	Depends on the configuration of the error

**If you cannot manage to eliminate a fault, please contact Wilo customer service or its nearest representative.**

## 11 Spare parts

Spare parts or repair orders may be ordered via a local specialist retailer and/or Wilo customer service. To avoid queries and incorrect orders, all data on the rating plate should be submitted with each order.

**Subject to change without prior notice**



## 12 Annex

### Details of the electrical cabinet terminal blocks

Terminal block no.	Terminal no.	Designation	Signal type
X0	L1	Connection voltage cabinet	Power supply performance (three-phase current 400 V, 50 Hz)
	L2		
	L3		
	PE		
X1	1	Pump motor	Output performance (three-phase current 400 V, 50 Hz, start star-delta)
	2		
	3		
	PE		
	4		
	5		
X4	1	Pump pressure switch in demand	DI (Pressure switch, contact closed when the pump is running correctly)
	2		
	3	Thermal protection pump	DI (Auxiliary contact of the thermal relay, contact closed when no malfunction)
	4		
	5	Malfunction level of cooling liquid	DI (float switch, closed in case of low level of glycol tank)
	6		
	7	Pressure switch 1	DI (contact closed when the pressure is high)
	8		
	9	Pressure switch 2	DI (contact closed when the pressure is high)
	10		
	11	Malfunction level start-up tank	DI (Float switch, contact open when the tank is full)
	12		
	13	Malfunction level of tank	DI (Float switch, contact open when the storage tank is full)
	14		
	15	Contact freely configurable	DI (logic adjustable in the menu)
	16		
	17	Contact freely configurable	DI (state of the DI searchable via modbus)
	18		
X7	1	General malfunction (2 contacts NO/NC)	DO (NO, contact open when an error exists)
	2		DO (NC, contact closed when an error exists)
	3		
	4		
	5	Pump in operation (2 contacts NO/NC)	DO (NO, contact closed when the pump is running)
	6		DO (NC, contact open when the pump is running)
	7		
	8		

	9	Malfunction level start-up tank (2 contacts NO/NC)	DO (NO, contact open when the tank level is low)
	10		
	11		DO (NO, contact closed when the tank level is low)
	12		
	13	Malfunction level of tank (2 contacts NO/NC)	DO (NO, contact open when the tank level is low)
	14		
	15		DO (NC, contact closed when the tank level is low)
	16		
	17	Malfunction level of cooling liquid (2 contacts, NO/NC)	DO (NO, contact open in the case of lack of glycol)
	18		
	19		DO (NC, contact closed in the case of lack of glycol)
	20		
	21	Contact freely configurable (2 contacts, NO/NC) (logic configurable in the menu)	DO (NO)
	22		
	23		DO (NC)
	24		
	25	Non-automatic mode 1 (2 contacts NO/NC)	DO (NO, contact open when the change-over switch 1 is not positioned on the automatic mode)
	26		
	27		DO (NC, contact closed when the change-over switch 1 is not positioned on the automatic mode)
	28		
	29	Non-automatic mode 2 (2 contacts NO/NC)	DO (NO, contact open when the change-over switch 2 is not positioned on the automatic mode)
	30		
	31		DO (NC, contact closed when the change-over switch 2 is not positioned on the automatic mode)
	32		
	33	Malfunction of the connection voltage (2 contacts, NO/NC)	DO (NO, contact open following a delay of 20 seconds in case of a power failure)
	34		
	35		DO (NC, contact closed following a delay of 20 seconds in case of a power failure)
	36		
	39	Activation failed	DO (NO, contact closed in the case of failed start)
	40		
	41	Malfunction connection of communication bus	DO (NO, contact closed in the case of malfunction of communication bus)
	42		
	43	Availability of the connection voltage	DO (NC, contact closed when the connection voltage is available)
	44		
X8	1	RS485 Modbus or Bacnet	Connection of communication bus
	2		

## External connections of the electric cabinet

	Function	Size of the cable gland	Number of wires per shroud and cross-section of the wires N07VK	Max length	
Digital inputs	Pressure switch no. 1	PG7	2 x 1 mm <sup>2</sup>	10 m	Electrical switchgear
	Pressure switch no. 2	PG7	2 x 1 mm <sup>2</sup>	10 m	
	Pressure switch "pump in demand"	PG7	2 x 1 mm <sup>2</sup>	10 m	
	Motor protection switch pump	PG7	2 x 1 mm <sup>2</sup>	10 m	
	Float switch level glycol	PG7	2 x 1 mm <sup>2</sup>	20 m	
	Float switch start-up tank	PG7	2 x 1 mm <sup>2</sup>	20 m	
	Float switch storage tank	PG7	2 x 1 mm <sup>2</sup>	20 m	
	Contact freely configurable	PG7	2 x 1 mm <sup>2</sup>	10 m	
Digital outputs (contact NO)	Malfunction start-up failed	Unused	2 x 1 mm <sup>2</sup>	10 m	
	Malfunction connection of communication bus	Unused	2 x 1 mm <sup>2</sup>	10 m	
Digital outputs (contact NC)	Malfunction availability of the connection voltage	Unused	2 x 1 mm <sup>2</sup>	10 m	
Connection bus	RS485 Modbus or Bacnet	Unused	2 x 1 mm <sup>2</sup>	10 m	
Digital outputs (contacts NO/NC)	General malfunction	Unused	2 x 1 mm <sup>2</sup>	10 m	
	Pump in operation	Unused	2 x 1 mm <sup>2</sup>	10 m	
	Low level of start-up tank	Unused	2 x 1 mm <sup>2</sup>	10 m	
	Low water level	Unused	2 x 1 mm <sup>2</sup>	10 m	
	Lack of glycol	Unused	2 x 1 mm <sup>2</sup>	10 m	
	Contact freely configurable	Unused	2 x 1 mm <sup>2</sup>	10 m	
	Non-auto mode 1	Unused	2 x 1 mm <sup>2</sup>	10 m	
	Non-auto mode 2	Unused	2 x 1 mm <sup>2</sup>	10 m	
	Connection voltage availability malfunction	Unused	2 x 1 mm <sup>2</sup>	10 m	

Performance input	Connection voltage three-phase 400 V AC	Cross-section of cable according to the size of the pump	10 m	
Performance output	Pump motor	Cross-section of cable according to the size of the pump	20 m	
Mass	GND	PG7	1 x 6 mm <sup>2</sup>	

# Details of the terminal blocks of the PCB master/slave

## SC-Comande Electric

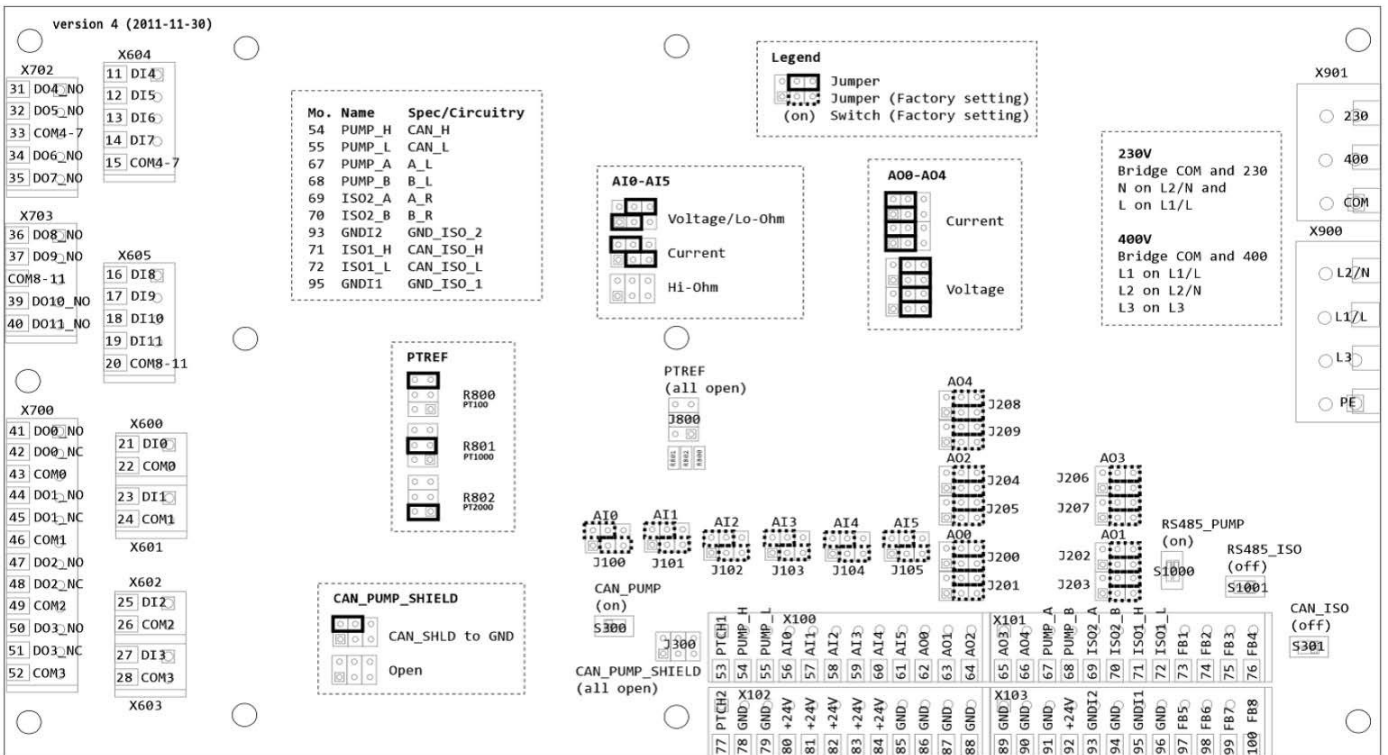
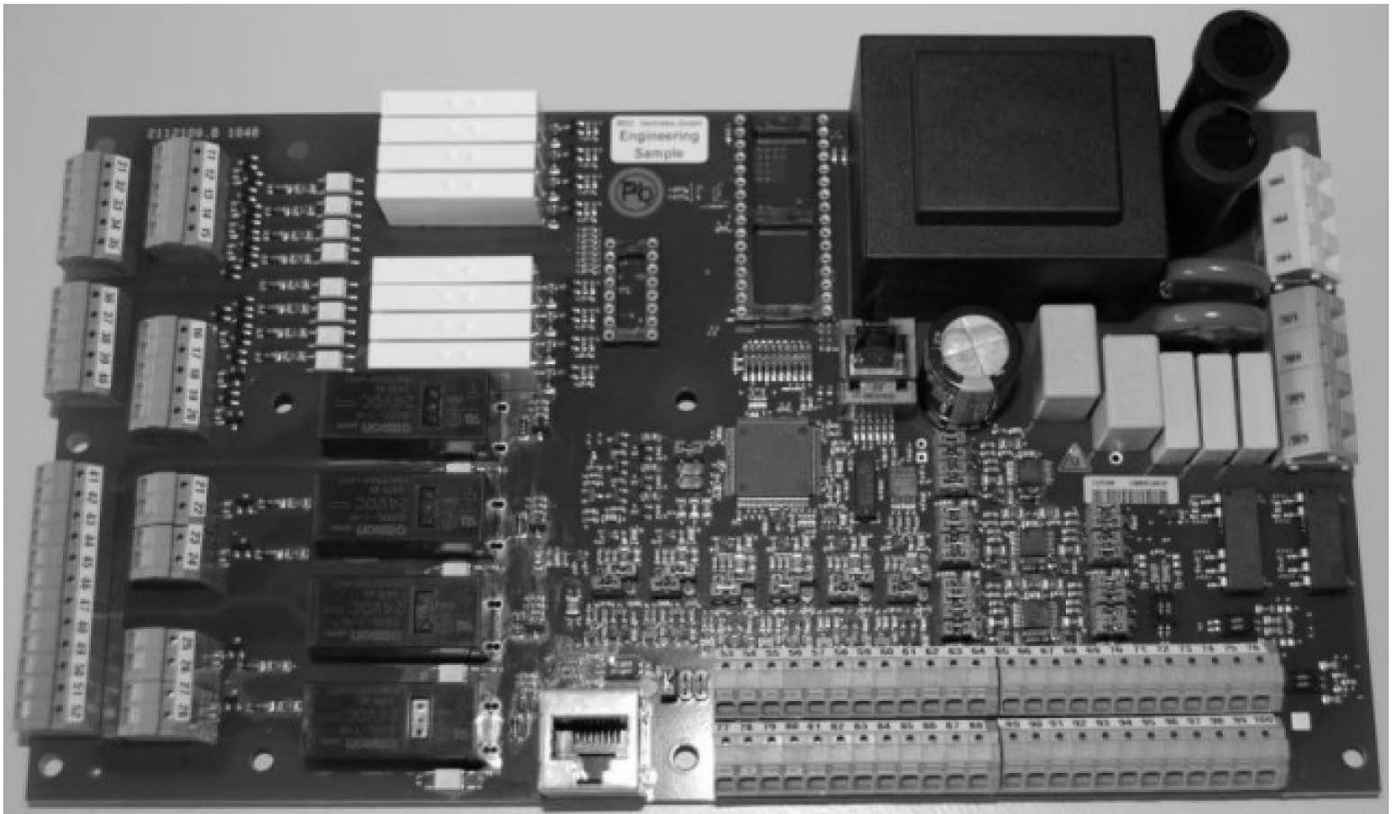

## Specification SC-Commande Electric

PCB 2U1 (Master)			PCB 2U2 (Slave)		
<b>X900</b>		<b>Used for:</b>	<b>X900</b>		<b>Used for:</b>
C		Selection by means of a shunt of the connection voltage (400 V only)	C		Selection by means of a shunt of the connection voltage (400 V only)
230 V			230 V		
400 V			400 V		
<b>X901</b>		<b>Used for:</b>	<b>X901</b>		<b>Used for:</b>
PE		Connection voltage (400 V only)	PE		Connection voltage (400 V only)
L3			L3		
L1(L)			L1(L)		
L2(N)			L2(N)		
<b>X100</b>		<b>Used for:</b>	<b>X100</b>		<b>Used for:</b>
53	Temp In 1		53	Temp In 1	
54	CAN_H		54	CAN_H	
55	CAN_L		55	CAN_L	
56	Analog In 0	Voltage measurement U1-U2	56	Analog In 0	
57	Analog In 1	Voltage measurement U1-U3	57	Analog In 1	
58	Analog In 2	Voltage measurement U2-U3	58	Analog In 2	
59	Analog In 3	Current measurement I1	59	Analog In 3	
60	Analog In 4	Current measurement I2	60	Analog In 4	
61	Analog In 5	Current measurement I3	61	Analog In 5	
62	Analog Out 0		62	Analog Out 0	
63	Analog Out 1		63	Analog Out 1	
64	Analog Out 2		64	Analog Out 2	
<b>X101</b>		<b>Used for:</b>	<b>X101</b>		<b>Used for:</b>
65	Analog Out 3		65	Analog Out 3	
66	Analog Out 4		66	Analog Out 4	
67	RS485_A_L		67	RS485_A_L	
68	RS485_B_L		68	RS485_B_L	
69	RS485_A_R	RS485: Output Modbus or Bacnet	69	RS485_A_R	
70	RS485_B_R	RS485: Output Modbus or Bacnet	70	RS485_B_R	
71	CAN_ISO_H	CAN: towards slave PCB (2U2)	71	CAN_ISO_H	CAN: towards LED/button PCB and towards master PCB (2U1)
72	CAN_ISO_L	CAN: towards slave PCB (2U2)	72	CAN_ISO_L	CAN: towards LED/button PCB and towards master PCB (2U1)
73	Field Bus1		73	Field Bus1	
74	Field Bus2		74	Field Bus2	
75	Field Bus3		75	Field Bus3	
76	Field Bus4		76	Field Bus4	
<b>X102</b>		<b>Used for:</b>	<b>X102</b>		<b>Used for:</b>
77	Temp In 2		77	Temp In 2	
78	GND	GND for digital outputs	78	GND	GND for digital outputs
79	GND	GND of the PCB 2U1	79	GND	GND of the PCB 2U2

80	VCC24V	Power supply 24 V DC for digital outputs	80	VCC24V	Power supply 24 V DC for digital outputs
81	VCC24V	Power supply 24 V DC of PCB	81	VCC24V	
82	VCC24V		82	VCC24V	
83	VCC24V		83	VCC24V	
84	VCC24V		84	VCC24V	
85	GND		85	GND	GND of transformer of LED
86	GND	GND towards PCB 2U2	86	GND	
87	GND		87	GND	
88	GND		88	GND	
<b>X103</b>		<b>Used for:</b>	<b>X103</b>		<b>Used for:</b>
89	GND		89	GND	
90	GND		90	GND	
91	GND		91	GND	Power supply of CAN: towards LED/button PCB
92	VCC24V	Power supply of CAN: towards LED/button PCB	92	VCC24V	Power supply of CAN: towards LED/button PCB
93	GND		93	GND	
94	GND		94	GND	
95	GND		95	GND	
96	GND		96	GND	CAN shielding: towards LED/button PCB
97	Field Bus5		97	Field Bus5	
98	Field Bus6		98	Field Bus6	
99	Field Bus7		99	Field Bus7	
100	Field Bus8		100	Field Bus8	
<b>X600</b>		<b>Used for:</b>	<b>X600</b>		<b>Used for:</b>
21	Digital In 0	Pressure switch 1	21	Digital In 0	Signalling trip circuit malfunction
22	COM 0	GND	22	COM 0	GND
<b>X601</b>		<b>Used for:</b>	<b>X601</b>		<b>Used for:</b>
23	Digital In 1	Pressure switch 2	23	Digital In 1	Trip circuit operation malfunction
24	COM 1	GND	24	COM 1	GND
<b>X602</b>		<b>Used for:</b>	<b>X602</b>		<b>Used for:</b>
25	Digital In 2	Float switch of the start-up tank – Low level	25	Digital In 2	Pump fuse malfunction
26	COM 2	GND	26	COM 2	GND
<b>X603</b>		<b>Used for:</b>	<b>X603</b>		<b>Used for:</b>
27	Digital In 3	Main water tank – Low level	27	Digital In 3	Pump in operation
28	COM 3	GND	28	COM 3	GND
<b>X604</b>		<b>Used for:</b>	<b>X604</b>		<b>Used for:</b>
11	Digital In 4	Pressure switch "pump in demand"	11	Digital In 4	Monitoring availability of the connection voltage 400 V
12	Digital In 5	Motor protection switch pump	12	Digital In 5	Free error message
13	Digital In 6	Key switch level 2	13	Digital In 6	
14	Digital In 7	Float switch – Lack of glycol	14	Digital In 7	
15	COM 4-7	GND	15	COM 4-7	GND
<b>X605</b>		<b>Used for:</b>	<b>X605</b>		<b>Used for:</b>

16	Digital In 8	Key switch no. 1 in Manual position	16	Digital In 8	
17	Digital In 9	Key switch no. 1 in Auto position	17	Digital In 9	
18	Digital In 10	Key switch no. 2 in Manual position	18	Digital In 10	Empty
19	Digital In 11	Key switch no. 2 in Auto position	19	Digital In 11	
20	COM 8-11	GND	20	COM 8-11	GND
<b>X700</b>		<b>Used for:</b>	<b>X700</b>		<b>Used for:</b>
41	Relay 0 NO	Activation failed	41	Relay 0 NO	Key switch in non-auto mode 1
42	Relay 0 NC		42	Relay 0 NC	
43	Relay 0 COM	COM (voltage EXT.)	43	Relay 0 COM	230 V AC
44	Relay 1 NO	Communication bus malfunction	44	Relay 1 NO	Key switch in non-auto mode 2
45	Relay 1 NC		45	Relay 1 NC	
46	Relay 1 COM	COM (voltage EXT.)	46	Relay 1 COM	230 V AC
47	Relay 2 NO		47	Relay 2 NO	
48	Relay 2 NC		48	Relay 2 NC	Buzzer
49	Relay 2 COM		49	Relay 2 COM	230 V AC
50	Relay 3 NO	Connection voltage availability malfunction	50	Relay 3 NO	Connection voltage malfunction
51	Relay 3 NC		51	Relay 3 NC	
52	Relay 3 COM	COM (voltage EXT.)	52	Relay 3 COM	230 V AC
<b>X702</b>		<b>Used for:</b>	<b>X702</b>		<b>Used for:</b>
31	Relay 4 NO	Main contactor	31	Relay 4 NO	General malfunction
32	Relay 5 NO	Delta contactor	32	Relay 5 NO	Pump in operation
33	Relay 4-7 COM	230 V AC	33	Relay 4-7 COM	230 V AC
34	Relay 6 NO	Star contactor	34	Relay 6 NO	
35	Relay 7 NO		35	Relay 7 NO	
<b>X703</b>		<b>Used for:</b>	<b>X703</b>		<b>Used for:</b>
36	Relay 8 NO		36	Relay 8 NO	Low level start-up tank
37	Relay 9 NO		37	Relay 9 NO	Low level main water tank
38	Relay 8-11 COM		38	Relay 8-11 COM	230 V AC
39	Relay 10 NO		39	Relay 10 NO	Low level glycol tank source A
40	Relay 11 NO		40	Relay 11 NO	Free error message









# wilo



Local contact at  
[www.wilo.com/contact](http://www.wilo.com/contact)

Pioneering for You

WILO SE  
Wilopark 1  
D-44263 Dortmund  
Germany  
T +49(0)231 4102-0  
F +49(0)231 4102-7363  
[wilo@wilo.com](mailto:wilo@wilo.com)  
[www.wilo.com](http://www.wilo.com)