

Submittal Data Sheet

Wilco CO-Helix - NSF 61/372 Pressure Boosting System

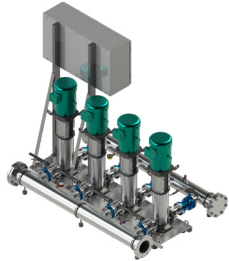

CO-4 HELIX V80-02-1/3/VCE



Project:	
Engineer:	
Contractor:	
Submitted By:	Date:
Approved By:	Date:

Tag #	Model #	Flow	BOOST PSI	Min. Inlet PSI	HP/Pump	Phase	Voltage	RPM
	CO-4 HELIX V80-02-1/3/VCE				3			3600

Article Number: 3313464 / 3313368 / 3313374 / 3313380

Applications

- Water Supply
- Pressure Boosting
- Agriculture
- Cooling Circuits
- Washing / Sprinkling Systems
- Condensate Return

Materials of Construction

Pump Volute	AISI304 stainless steel with ANSI flanges
Impeller	3D Laser welded AISI 304 Stainless Steel
Shaft	AISI304, AISI318 LN, or AISI431 Stainless Steel
Elastomers	EPDM
Isolation Valves	Cast Iron Wafer Butterfly, All Stainless Steel Wetted Components
Manifolds	304 SS with 150 Class ANSI Flanges
Check Valves	Cast Iron Body with All Stainless Steel Wetted Components, Spring-loaded non-slam
Mechanical Seal	Cartridge Seal: Sleeve AISI316L / Spring Clips AISI304
Pressure Transducers	316 Stainless Steel
Pressure Gauges	304 Stainless Steel Housing with 316 Stainless Steel wetted parts
System Base	Steel (S235JR)
Vibration Isolators	Neoprene, Height Adjustable

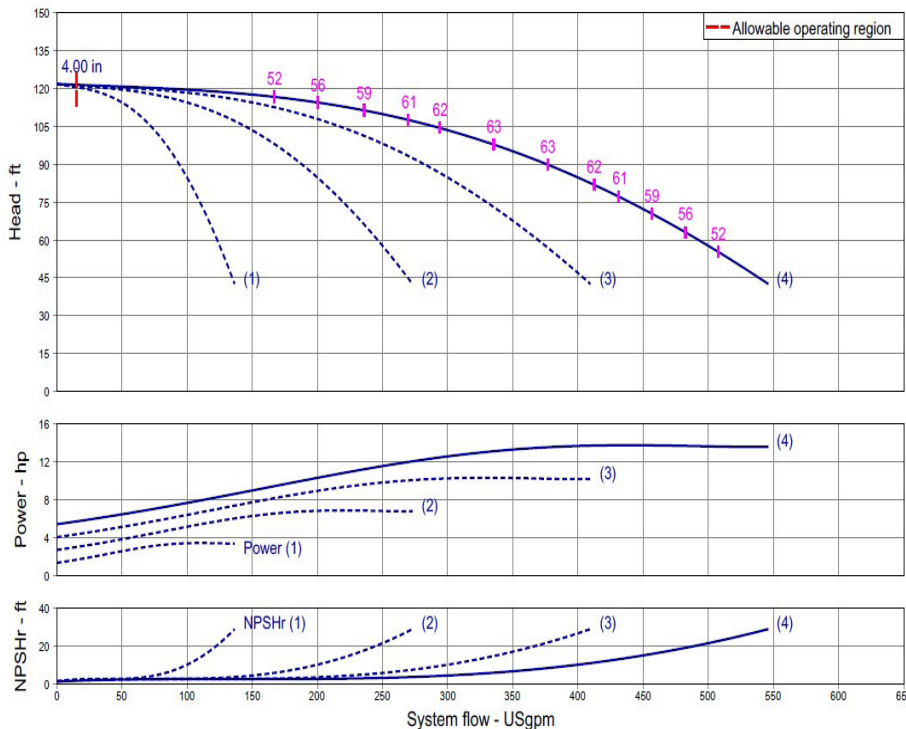

Technical Data - Operational Ranges

Liquid Temp Range	-4°F to +180°F (Min. 32 °F for Domestic Water)
Ambient Temp Range	+32°F to +104 °F
Max System Pressure	232 PSI

Technical Data - Panel

Power Supply	208-230/460-3 or 575-3
Enclosure	NEMA 12 (3R Available Upon Request)
Standard	Meets UL 508A
Variable Frequency Drives	Danfoss FC-51: • 1 to 5 HP for 208-230/460v~3 Danfoss FC-101: • 7.5 to 20HP 208-230V~3 • 1 to 10HP 208-230-1 IN / 208-230-3 OUT • 15 to 20HP 460V~3 • 1 to 20HP 575V~3

Technical Data - PLC

User Interface	7" Diagonal Color LCD Touchscreen
Display Resolution	800 x 480 Pixels
Supply Voltage	24VDC
Max. Current Consumption	320mA@24V
Number of Analog Inputs	9
Number of Analog Outputs	2
Number of Digital Inputs	18
Number of Digital Outputs	17
Onboard Communications	Modbus Protocol (Optional Gateways for BACnet, LonWorks, and CANbus)
Ethernet Port	RJ45 port capable of transmitting data 10/100Mbps
Additional Ports	2.0 USB Port; Micro-SD Port

Motor Data

Power Supply	208-230, 460, 575-3
Motor Enclosure	Totally Enclosed Fan Cooled (TEFC)
Motor Efficiency	Nema Premium Efficiency - Meets NEMA 12-12 Rule
Enclosure Construction	Rolled Steel / Cast Iron
Motor Protection Index	IP54
Insulation Class	F

Approval Stamp

Submittal Data Sheet

Wilo CO-Helix – NSF 61/372 Pressure Boosting System



CO-4 HELIX V80-02-1/3/VCE

208-230 V ~1in/~3out

208-230 V~3/460 V~3

575 V~3

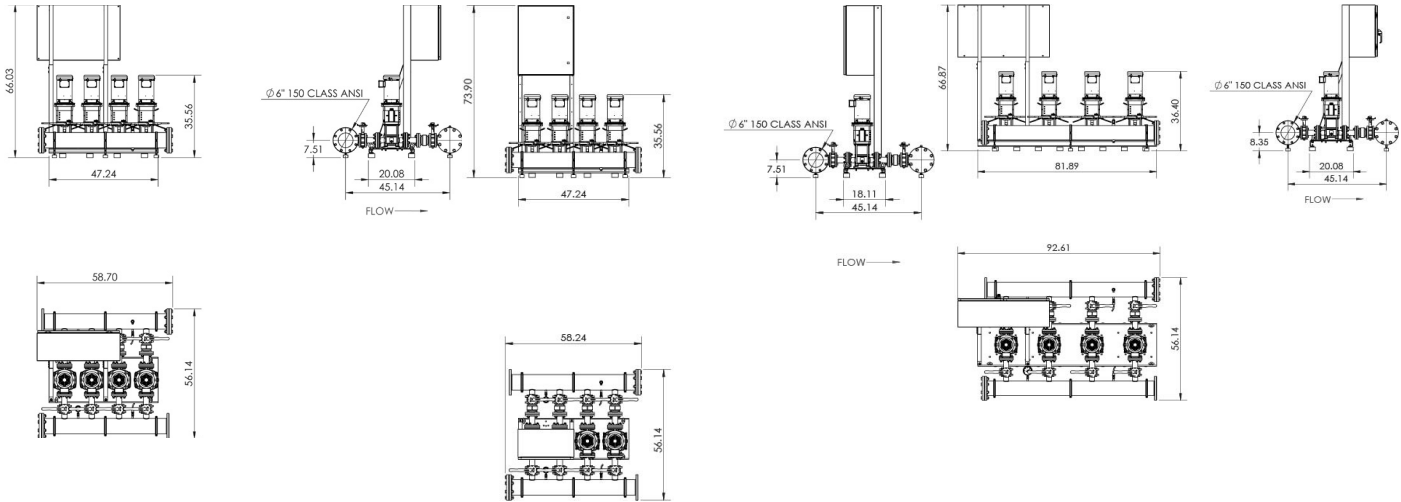

Special Note: All weights and dimensions are approximate and should not be used as exact rough-in dimensions

Dimensions and Weights

Model	Voltage (V)	H (in)	W (in)	L (in)	Dimensions-inches					Individual Pump Weight	Package Weight
					System Header Size	Suction / Discharge Pump Size (300 Class ANSI)	Gauge Tap Size	Transducer Tap Size	Hydronumatic Tank Valve on Manifold (Plugged)	Pump Weight (lbs)	Package Weight (lbs)
CO-4 HELIX V80-02-1/3/VCE	208-230V-1 IN/ 208-230V-3OUT	66	58-3/4	56-1/5	6" 150 ANSI Class	2"	1/4" FNPT	1/4" FNPT	3/4" MNPT x 3/4" FNPT	93	1,282
	208-230/460 V	74	58-1/4	56-1/5							
	575 V	66-7/8	92-3/5	56-1/5							

TEFC Motor Data (per motor)

Model	P2 (HP)	Phase (-)	Voltage (V)	Motor FLA (per pump) (A)	System FLA	Pmax (PSI)
CO-4 HELIX V80-02-1/3/VCE	3	1	208-230V-1 IN/ 208-230V-3OUT	12-11.8	61.8	232
		3	208-230/460/575	12-11.8/5.9/4.7	39.4/20.2/15	

Submittal Data Sheet

Wilo CO-Helix – NSF 61/372 Pressure Boosting System



CO-4 HELIX V80-02-1/5/VCE

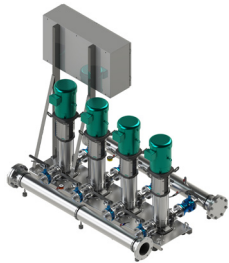

Project:	
Engineer:	
Contractor:	
Submitted By:	Date:
Approved By:	Date:

Tag #	Model #	Flow	BOOST PSI	Min. Inlet PSI	HP/Pump	Phase	Voltage	RPM
	CO-4 HELIX V80-02-1/5/VCE				5			3600

Article Number: 3313466 / 3313369 / 3313375 / 3313381

Applications

- Water Supply
- Pressure Boosting
- Agriculture
- Cooling Circuits
- Washing / Sprinkling Systems
- Condensate Return

Materials of Construction

Pump Volute	AISI304 stainless steel with ANSI flanges
Impeller	3D Laser welded AISI 304 Stainless Steel
Shaft	AISI304, AISI318 LN, or AISI431 Stainless Steel
Elastomers	EPDM
Isolation Valves	Cast Iron Wafer Butterfly, All Stainless Steel Wetted Components
Manifolds	304 SS with 150 Class ANSI Flanges
Check Valves	Cast Iron Body with All Stainless Steel Wetted Components, Spring-loaded non-slam
Mechanical Seal	Cartridge Seal: Sleeve AISI316L / Spring Clips AISI304
Pressure Transducers	316 Stainless Steel
Pressure Gauges	304 Stainless Steel Housing with 316 Stainless Steel wetted parts
System Base	Steel (S235JR)
Vibration Isolators	Neoprene, Height Adjustable

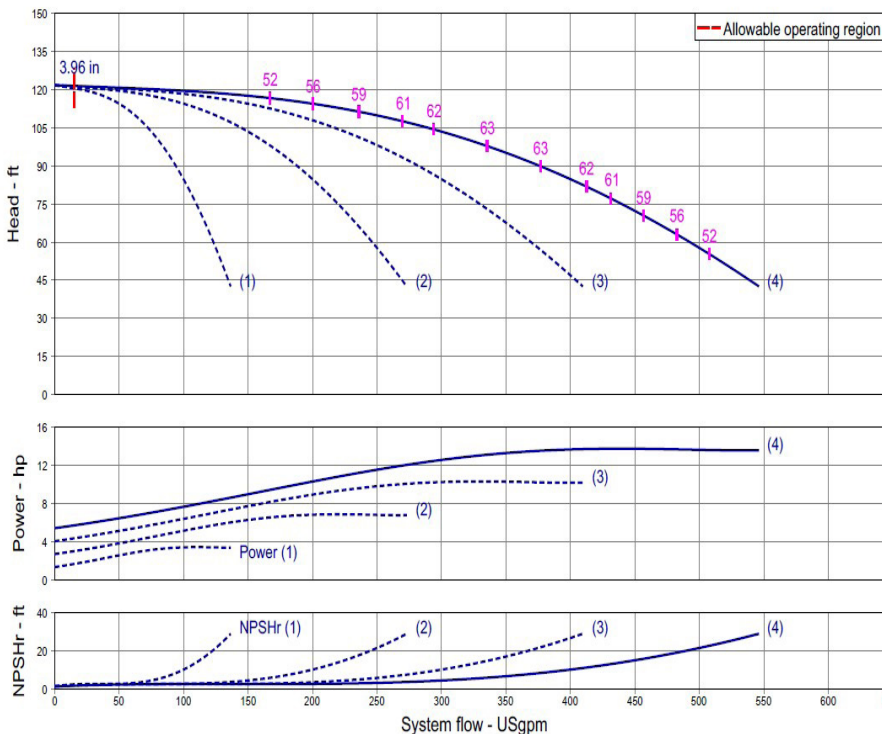

Technical Data – Operational Ranges

Liquid Temp Range	-4°F to +180°F (Min. 32 °F for Domestic Water)
Ambient Temp Range	+32°F to +104 °F
Max System Pressure	232 PSI

Technical Data – Panel

Power Supply	208–230/460~3 or 575~3
Enclosure	NEMA 12 (3R Available Upon Request)
Standard	Meets UL 508A
Variable Frequency Drives	Danfoss FC-51: • 1 to 5 HP for 208-230/460v~3 Danfoss FC-101: • 7.5 to 20HP 208-230V~3 • 1 to 10HP 208-230~1 IN / 208-230~3 OUT • 15 to 20HP 460V~3 • 1 to 20HP 575V~3

Technical Data – PLC

User Interface	7" Diagonal Color LCD Touchscreen
Display Resolution	800 x 480 Pixels
Supply Voltage	24VDC
Max. Current Consumption	320mA@24V
Number of Analog Inputs	9
Number of Analog Outputs	2
Number of Digital Inputs	18
Number of Digital Outputs	17
Onboard Communications	Modbus Protocol (Optional Gateways for BACnet, LonWorks, and CANbus)
Ethernet Port	RJ45 port capable of transmitting data 10/100Mbps
Additional Ports	2.0 USB Port; Micro-SD Port

Motor Data

Power Supply	208–230, 460, 575~3
Motor Enclosure	Totally Enclosed Fan Cooled (TEFC)
Motor Efficiency	Nema Premium Efficiency – Meets NEMA 12-12 Rule
Enclosure Construction	Rolled Steel / Cast Iron
Motor Protection Index	IP54
Insulation Class	F

Approval Stamp

Submittal Data Sheet

Wilo CO-Helix - NSF 61/372 Pressure Boosting System



CO-4 HELIX V80-02-1/5/VCE

208-230 V ~1in/~3out

208-230 V~3

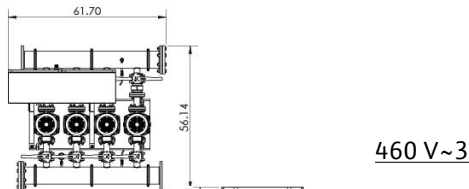
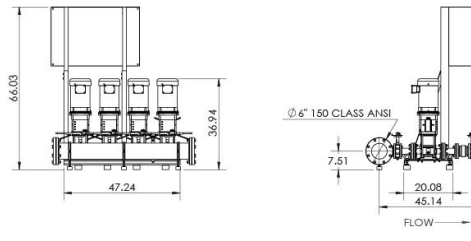
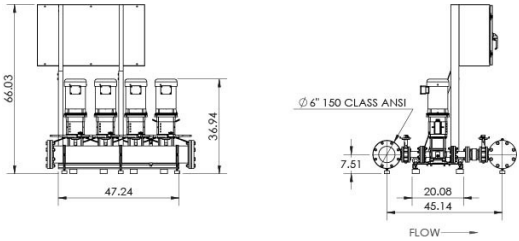

460 V~3

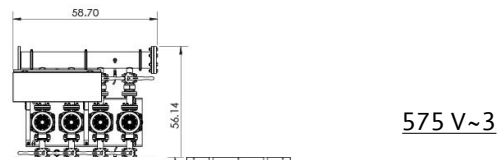

575 V~3

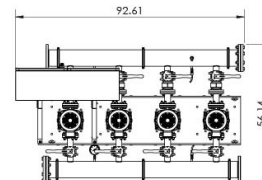
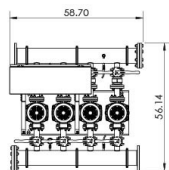
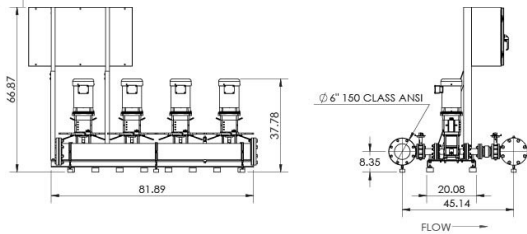
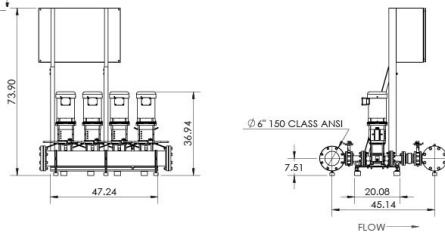

Special Note: All weights and dimensions are approximate and should not be used as exact rough-in dimensions

Dimensions and Weights

Model	Voltage (V)	Dimensions-inches				System Header Size	Suction / Discharge Pump Size (300 Class ANSI)	Gauge Tap Size	Transducer Tap Size	Hydronumatic Tank Valve on Manifold (Plugged)	Individual Pump Weight	Package Weight
		H (in)	W (in)	L (in)	Pump Weight (lbs)						Package Weight (lbs)	
CO-3 HELIX V80-02-1/5/VCE	208-230 V ~1IN/ 208-230 V~3OUT	66	61-3/4	56-1/5	6" 150 ANSI Class	2"	1/4" FNPT	1/4" FNPT	3/4" MNPT x 3/4" FNPT	93	1,282	
	208-230 V	66	58-3/4	56-1/5								
	460 V	74	58-3/4	56-1/5								
	575 V	66-7/8	92-3/5	56-1/5								

TEFC Motor Data (per motor)

Model	P2 (HP)	Phase (-)	Voltage (V)	Motor FLA (per pump) (A)	System FLA	Pmax (PSI)
CO-4 HELIX V80-02-1/5/VCE	5	1	208-230V-1 IN/ 208-230V-3OUT	12-11.8	97	232
		3	208-230/460/575	12-11.8/5.9/4.7	61.8/33.8/23.4	

WILO USA LLC +1 262 204-6600
www.wilo-usa.com
info@wilo-usa.com

WILO Canada Inc. +1 403 276-9456
www.wilo-canada.com
info@wilo-canada.com

Submittal Data Sheet

Wilo CO-Helix – NSF 61/372 Pressure Boosting System



CO-4 HELIX V80-03-1/5/VCE



Project:	
Engineer:	
Contractor:	
Submitted By:	Date:
Approved By:	Date:

Tag #	Model #	Flow	BOOST PSI	Min. Inlet PSI	HP/Pump	Phase	Voltage	RPM
	CO-4 HELIX V80-03-1/5/VCE				5			3600

Article Number: 3313467 / 3313370 / 3313376 / 3313382

Applications

- Water Supply
- Pressure Boosting
- Agriculture
- Cooling Circuits
- Washing / Sprinkling Systems
- Condensate Return

Materials of Construction

Pump Volute	AISI304 stainless steel with ANSI flanges
Impeller	3D Laser welded AISI 304 Stainless Steel
Shaft	AISI304, AISI318 LN, or AISI431 Stainless Steel
Elastomers	EPDM
Isolation Valves	Cast Iron Wafer Butterfly, All Stainless Steel Wetted Components
Manifolds	304 SS with 150 Class ANSI Flanges
Check Valves	Cast Iron Body with All Stainless Steel Wetted Components, Spring-loaded non-slam
Mechanical Seal	Cartridge Seal: Sleeve AISI316L / Spring Clips AISI304
Pressure Transducers	316 Stainless Steel
Pressure Gauges	304 Stainless Steel Housing with 316 Stainless Steel wetted parts
System Base	Steel (S235JR)
Vibration Isolators	Neoprene, Height Adjustable

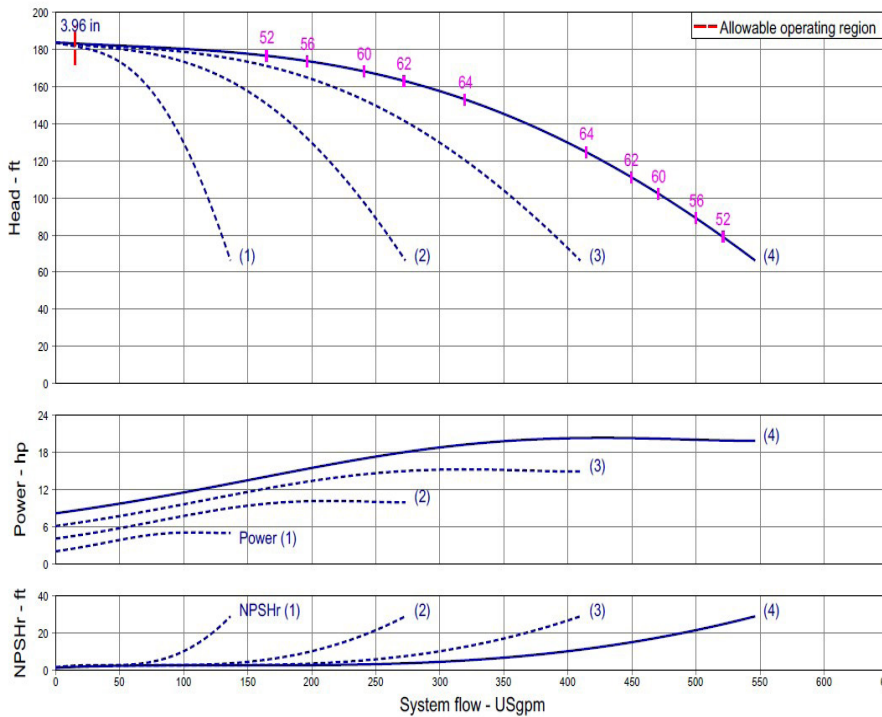

Technical Data – Operational Ranges

Liquid Temp Range	-4°F to +180°F (Min. 32 °F for Domestic Water)
Ambient Temp Range	+32°F to +104 °F
Max System Pressure	232 PSI

Technical Data – Panel

Power Supply	208–230/460~3 or 575~3
Enclosure	NEMA 12 (3R Available Upon Request)
Standard	Meets UL 508A
Variable Frequency Drives	Danfoss FC-51: • 1 to 5 HP for 208-230/460v~3 Danfoss FC-101: • 7.5 to 20HP 208-230V~3 • 1 to 10HP 208-230~1 IN/208-230~3 OUT • 15 to 20HP 460V~3 • 1 to 20HP 575V~3

Technical Data – PLC

User Interface	7" Diagonal Color LCD Touchscreen
Display Resolution	800 x 480 Pixels
Supply Voltage	24VDC
Max. Current Consumption	320mA@24V
Number of Analog Inputs	9
Number of Analog Outputs	2
Number of Digital Inputs	18
Number of Digital Outputs	17
Onboard Communications	Modbus Protocol (Optional Gateways for BACnet, LonWorks, and CANbus)
Ethernet Port	RJ45 port capable of transmitting data 10/100Mbps
Additional Ports	2.0 USB Port; Micro-SD Port

Motor Data

Power Supply	208-230, 460, 575-3
Motor Enclosure	Totally Enclosed Fan Cooled (TEFC)
Motor Efficiency	Nema Premium Efficiency – Meets NEMA 12-12 Rule
Enclosure Construction	Rolled Steel / Cast Iron
Motor Protection Index	IP54
Insulation Class	F

Approval Stamp

Submittal Data Sheet

Wilo CO-Helix – NSF 61/372 Pressure Boosting System



CO-4 HELIX V80-03-1/5/VCE

208-230 V ~1in/~3out

208-230/460 V~3

575 V~3

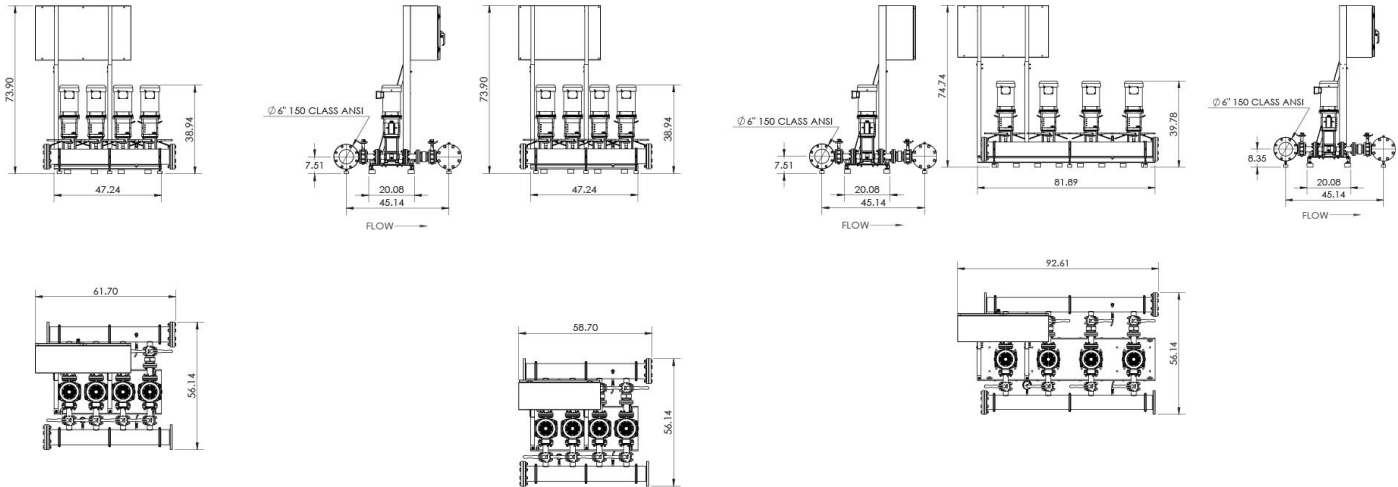

Special Note: All weights and dimensions are approximate and should not be used as exact rough-in dimensions

Dimensions and Weights

Model	Voltage (V)	Dimensions-inches								Individual Pump Weight	Package Weight
		H (in)	W (in)	L (in)	System Header Size	Suction / Discharge Pump Size (300 Class ANSI)	Gauge Tap Size	Transducer Tap Size	Hydronomous Tank Valve on Manifold (Plugged)	Pump Weight (lbs)	Package Weight (lbs)
CO-4 HELIX V80-03-1/5/VCE	208-230V-1 IN/208-230V-3OUT	74	61-3/4	56-1/5	6" 150 ANSI Class	2"	1/4" FNPT	1/4" FNPT	3/4" MNPT x 3/4" FNPT	101	1,294
	208-230/460 V	74	58-1/4	56-1/5							
	575 V	74	92-2/3	56-1/5							

TEFC Motor Data (per motor)

Model	P2 (HP)	Phase (-)	Voltage (V)	Motor FLA (per pump) (A)	System FLA	Pmax (PSI)
CO-4 HELIX V80-03-1/5/VCE	5	1	208-230V-1 IN/208-230V-3OUT	12-11.8	97	232
		3	208-230/460/575	12-11.8/5.9/4.7	61.8/33.8/23.4	

Submittal Data Sheet

Wilco CO-Helix - NSF 61/372 Pressure Boosting System



CO-4 HELIX V80-04-1/7.5/VCE

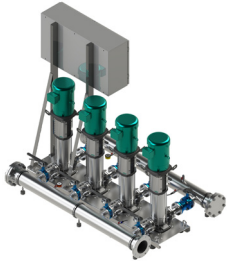

Project:	
Engineer:	
Contractor:	
Submitted By:	Date:
Approved By:	Date:

Tag #	Model #	Flow	BOOST PSI	Min. Inlet PSI	HP/Pump	Phase	Voltage	RPM
	CO-4 HELIX V80-04-1/7.5/VCE				7.5			3600

Article Number: 3313371 / 3313377 / 3313383

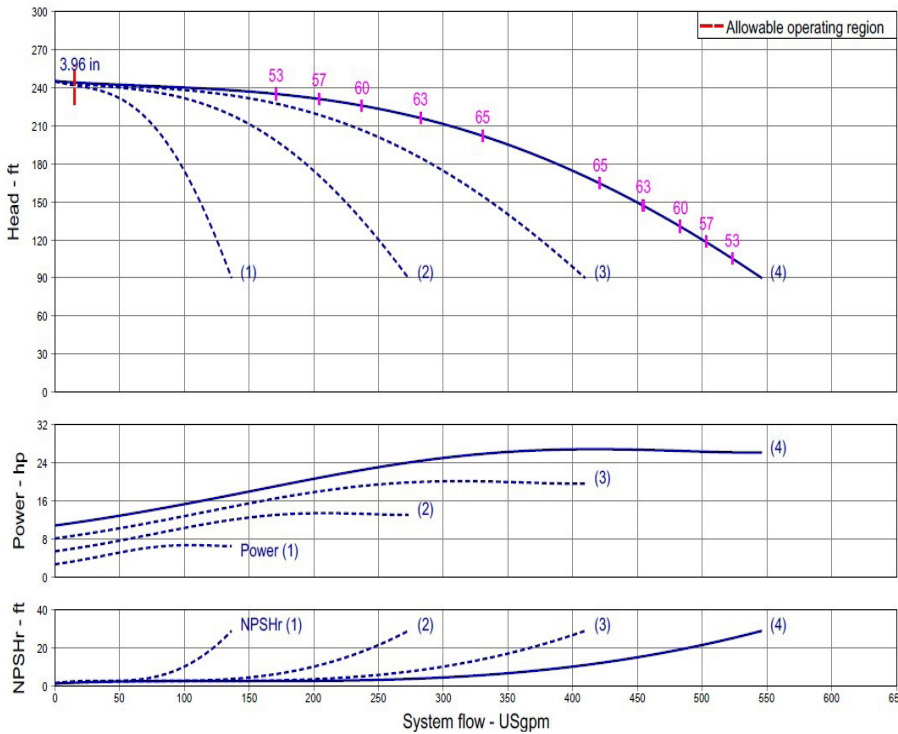

Applications

- Water Supply
- Pressure Boosting
- Agriculture
- Cooling Circuits
- Washing / Sprinkling Systems
- Condensate Return

Materials of Construction

Pump Volute	AISI304 stainless steel with ANSI flanges
Impeller	3D Laser welded AISI 304 Stainless Steel
Shaft	AISI304, AISI318 LN, or AISI431 Stainless Steel
Elastomers	EPDM
Isolation Valves	Cast Iron Wafer Butterfly, All Stainless Steel Wetted Components
Manifolds	304 SS with 150 Class ANSI Flanges
Check Valves	Cast Iron Body with All Stainless Steel Wetted Components, Spring-loaded non-slam
Mechanical Seal	Cartridge Seal: Sleeve AISI316L / Spring Clips AISI304
Pressure Transducers	316 Stainless Steel
Pressure Gauges	304 Stainless Steel Housing with 316 Stainless Steel wetted parts
System Base	Steel (S235JR)
Vibration Isolators	Neoprene, Height Adjustable

Technical Data - Operational Ranges

Liquid Temp Range	-4°F to +180°F (Min. 32 °F for Domestic Water)
Ambient Temp Range	+32°F to +104 °F
Max System Pressure	232 PSI

Technical Data - Panel

Power Supply	208-230/460-3 or 575-3
Enclosure	NEMA 12 (3R Available Upon Request)
Standard	Meets UL 508A
Variable Frequency Drives	Danfoss FC-51: • 1 to 5 HP for 208-230/460v~3 Danfoss FC-101: • 7.5 to 20HP 208-230V~3 • 1 to 10HP 208-230-1 IN / 208-230-3 OUT • 15 to 20HP 460V~3 • 1 to 20HP 575V~3

Technical Data - PLC

User Interface	7" Diagonal Color LCD Touchscreen
Display Resolution	800 x 480 Pixels
Supply Voltage	24VDC
Max. Current Consumption	320mA@24V
Number of Analog Inputs	9
Number of Analog Outputs	2
Number of Digital Inputs	18
Number of Digital Outputs	17
Onboard Communications	Modbus Protocol (Optional Gateways for BACnet, LonWorks, and CANbus)
Ethernet Port	RJ45 port capable of transmitting data 10/100Mbps
Additional Ports	2.0 USB Port; Micro-SD Port

Motor Data

Power Supply	208-230, 460, 575-3
Motor Enclosure	Totally Enclosed Fan Cooled (TEFC)
Motor Efficiency	Nema Premium Efficiency - Meets NEMA 12-12 Rule
Enclosure Construction	Rolled Steel / Cast Iron
Motor Protection Index	IP54
Insulation Class	F

Approval Stamp

Submittal Data Sheet

Wilo CO-Helix - NSF 61/372 Pressure Boosting System



CO-4 HELIX V80-04-1/7.5/VCE

208-230 V~3

460 V~3

575 V~3

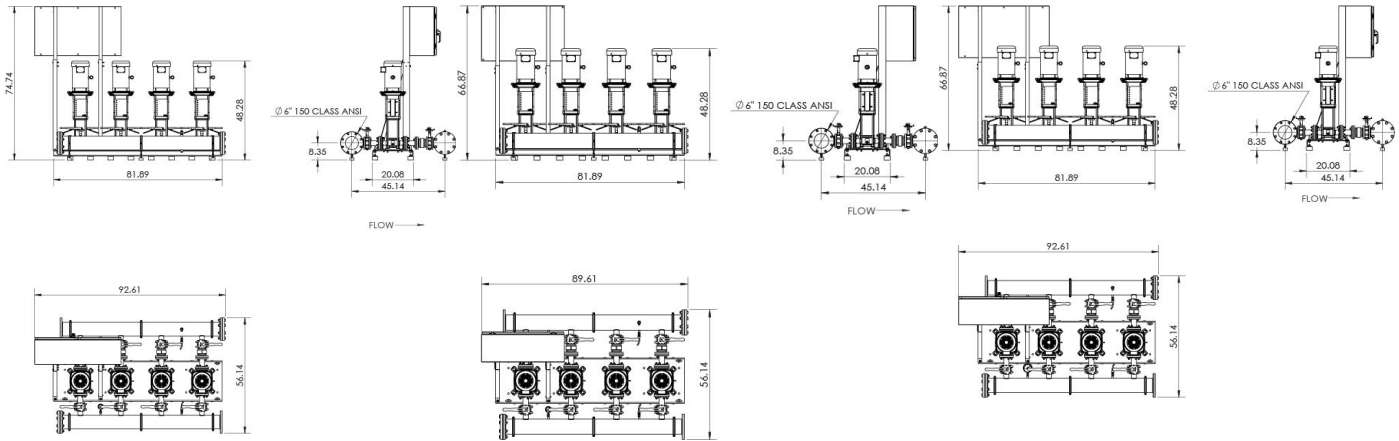

Special Note: All weights and dimensions are approximate and should not be used as exact rough-in dimensions

Dimensions and Weights

Model	Voltage (V)	H (in)	W (in)	L (in)	System Header Size	Dimensions-inches				Individual Pump Weight	Package Weight
						Suction / Discharge Pump Size (300 Class ANSI)	Gauge Tap Size	Transducer Tap Size	Hydrunomatic Tank Valve on Manifold (Plugged)	Pump Weight (lbs)	Package Weight (lbs)
CO-4 HELIX V80-04-1/7.5/VCE	208-230 V	74-3/4	92-2/3	56-1/5	6" 150 ANSI Class	2"	1/4" FNPT	1/4" FNPT	3/4" MNPT x 3/4" FNPT	133	1,600
	460 V	66-7/8	89-2/3	56-1/5							
	575 V	66-7/8	92-2/3	56-1/5							

TEFC Motor Data

Model	P2 (HP)	Phase (-)	Voltage (V)	FLA (per pump) (A)	System FLA	Pmax (PSI)
CO-4 HELIX V80-04-1/7.5/VCE	7.5	3	208-230/460/575	17.2-16.2/8.1/6.8	85-73/45/34.2	232

Submittal Data Sheet

Wilco CO-Helix - NSF 61/372 Pressure Boosting System



CO-4 HELIX V80-05-1/10/VCE

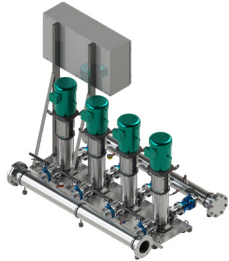

Project:	
Engineer:	
Contractor:	
Submitted By:	Date:
Approved By:	Date:

Tag #	Model #	Flow	BOOST PSI	Min. Inlet PSI	HP/Pump	Phase	Voltage	RPM
	CO-4 HELIX V80-05-1/10/VCE				10			3600

Article Number: 3313372 / 3313378 / 3313384

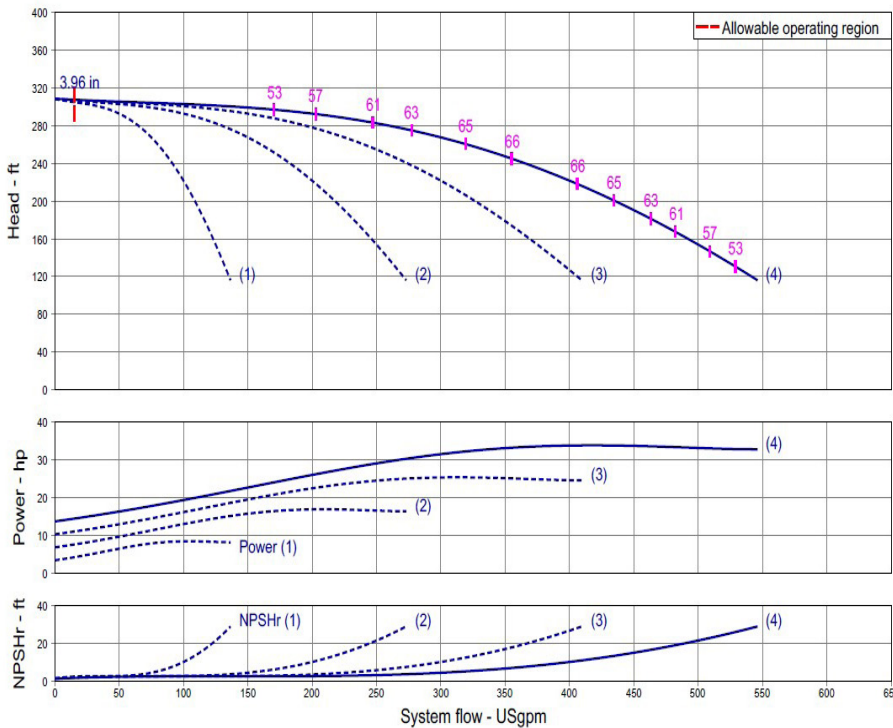

Applications

- Water Supply
- Pressure Boosting
- Agriculture
- Cooling Circuits
- Washing / Sprinkling Systems
- Condensate Return

Materials of Construction

Pump Volute	AISI304 stainless steel with ANSI flanges
Impeller	3D Laser welded AISI 304 Stainless Steel
Shaft	AISI304, AISI318 LN, or AISI431 Stainless Steel
Elastomers	EPDM
Isolation Valves	Cast Iron Wafer Butterfly, All Stainless Steel Wetted Components
Manifolds	304 SS with 150 Class ANSI Flanges
Check Valves	Cast Iron Body with All Stainless Steel Wetted Components, Spring-loaded non-slam
Mechanical Seal	Cartridge Seal: Sleeve AISI316L / Spring Clips AISI304
Pressure Transducers	316 Stainless Steel
Pressure Gauges	304 Stainless Steel Housing with 316 Stainless Steel wetted parts
System Base	Steel (S235JR)
Vibration Isolators	Neoprene, Height Adjustable

Technical Data - Operational Ranges

Liquid Temp Range	-4°F to +180°F (Min. 32 °F for Domestic Water)
Ambient Temp Range	+32°F to +104 °F
Max System Pressure	232 PSI

Technical Data - Panel

Power Supply	208-230/460-3 or 575-3
Enclosure	NEMA 12 (3R Available Upon Request)
Standard	Meets UL 508A
Variable Frequency Drives	Danfoss FC-51: • 1 to 5 HP for 208-230/460v-3 Danfoss FC-101: • 7.5 to 20HP 208-230V-3 • 1 to 10HP 208-230-1 IN / 208-230-3 OUT • 15 to 20HP 460V-3 • 1 to 20HP 575V-3

Technical Data - PLC

User Interface	7" Diagonal Color LCD Touchscreen
Display Resolution	800 x 480 Pixels
Supply Voltage	24VDC
Max. Current Consumption	320mA@24V
Number of Analog Inputs	9
Number of Analog Outputs	2
Number of Digital Inputs	18
Number of Digital Outputs	17
Onboard Communications	Modbus Protocol (Optional Gateways for BACnet, LonWorks, and CANbus)
Ethernet Port	RJ45 port capable of transmitting data 10/100Mbps
Additional Ports	2.0 USB Port; Micro-SD Port

Motor Data

Power Supply	208-230, 460, 575-3
Motor Enclosure	Totally Enclosed Fan Cooled (TEFC)
Motor Efficiency	Nema Premium Efficiency - Meets NEMA 12-12 Rule
Enclosure Construction	Rolled Steel / Cast Iron
Motor Protection Index	IP54
Insulation Class	F

Approval Stamp

Submittal Data Sheet

Wilo CO-Helix - NSF 61/372 Pressure Boosting System



CO-4 HELIX V80-05-1/10/VCE

208-230 V~3

460 V~3

575 V~3

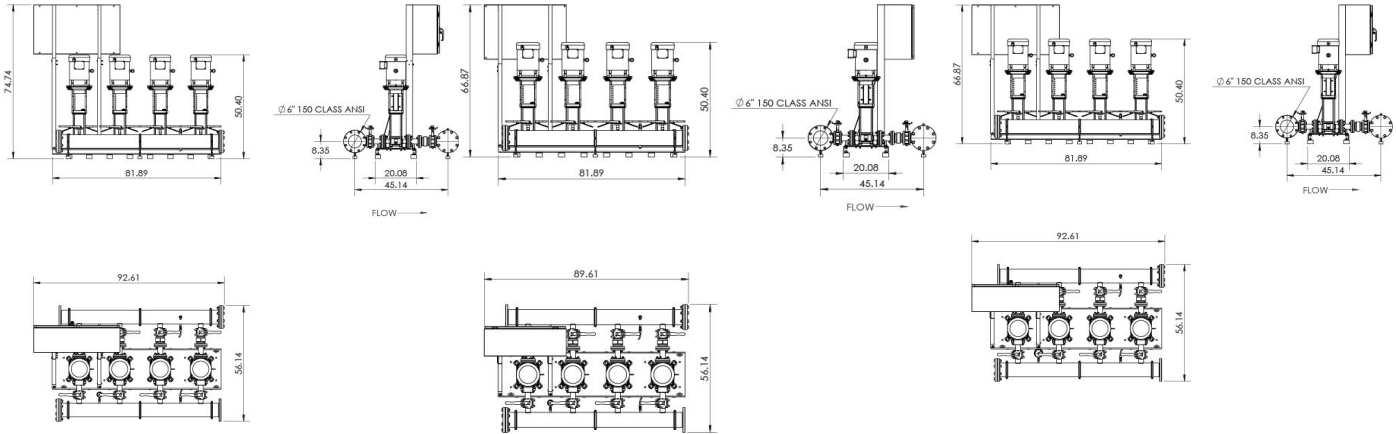

Special Note: All weights and dimensions are approximate and should not be used as exact rough-in dimensions

Dimensions and Weights

Model	Voltage (V)	H (in)	W (in)	L (in)	System Header Size	Dimensions-inches				Individual Pump Weight	Package Weight
						Suction / Discharge Pump Size (300 Class ANSI)	Gauge Tap Size	Transducer Tap Size	Hydronumatic Tank Valve on Manifold (Plugged)	Pump Weight (lbs)	Package Weight (lbs)
CO-4 HELIX V80-05-1/10/VCE	208-230 V	74-3/4	92-2/3	56-1/5	6" 150 ANSI Class	2"	1/4" FNPT	1/4" FNPT	3/4" MNPT x 3/4" FNPT	142	1,724
	460 V	66-7/8	89-2/3	56-1/5							
	575 V	66-7/8	92-2/3	56-1/5							

TEFC Motor Data

Model	P2 (HP)	Phase (-)	Voltage (V)	FLA (per pump) (A)	System FLA	Pmax (PSI)
CO-4 HELIX V80-05-1/10/VCE	10	3	208-230/460/575	24.8-24.2/12.1/9.5	114.2-97/57/46.6	232

Submittal Data Sheet

Wilco CO-Helix - NSF 61/372 Pressure Boosting System



CO-4 HELIX V80-06-1/10/VCE

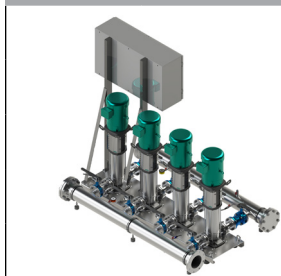

Project:	
Engineer:	
Contractor:	
Submitted By:	Date:
Approved By:	Date:

Tag #	Model #	Flow	BOOST PSI	Min. Inlet PSI	HP/Pump	Phase	Voltage	RPM
	CO-4 HELIX V80-06-1/10/VCE				10			3600

Article Number: 3313373 / 3313379 / 3313385

Applications

- Water Supply
- Pressure Boosting
- Agriculture
- Cooling Circuits
- Washing / Sprinkling Systems
- Condensate Return

Materials of Construction

Pump Volute	AISI304 stainless steel with ANSI flanges
Impeller	3D Laser welded AISI 304 Stainless Steel
Shaft	AISI304, AISI318 LN, or AISI431 Stainless Steel
Elastomers	EPDM
Isolation Valves	Cast Iron Wafer Butterfly, All Stainless Steel Wetted Components
Manifolds	304 SS with 150 Class ANSI Flanges
Check Valves	Cast Iron Body with All Stainless Steel Wetted Components, Spring-loaded non-slam
Mechanical Seal	Cartridge Seal: Sleeve AISI316L / Spring Clips AISI304
Pressure Transducers	316 Stainless Steel
Pressure Gauges	304 Stainless Steel Housing with 316 Stainless Steel wetted parts
System Base	Steel (S235JR)
Vibration Isolators	Neoprene, Height Adjustable

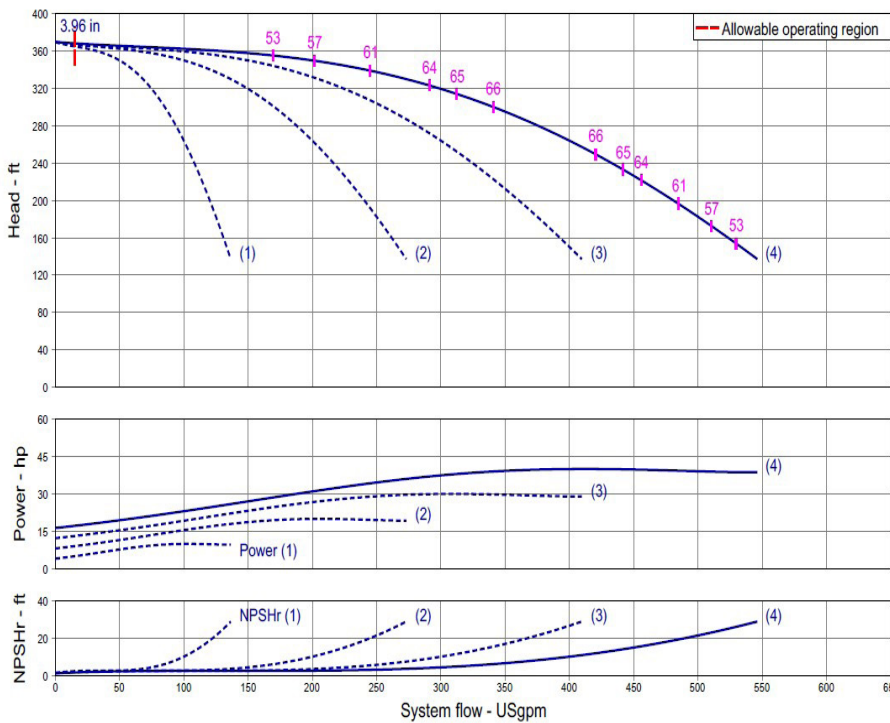

Technical Data - Operational Ranges

Liquid Temp Range	-4°F to +180°F (Min. 32 °F for Domestic Water)
Ambient Temp Range	+32°F to +104 °F
Max System Pressure	232 PSI

Technical Data - Panel

Power Supply	208-230/460-3 or 575-3
Enclosure	NEMA 12 (3R Available Upon Request)
Standard	Meets UL 508A
Variable Frequency Drives	Danfoss FC-51: • 1 to 5 HP for 208-230/460v-3 Danfoss FC-101: • 7.5 to 20HP 208-230V-3 • 1 to 10HP 208-230-1 IN / 208-230-3 OUT • 15 to 20HP 460V-3 • 1 to 20HP 575V-3

Technical Data - PLC

User Interface	7" Diagonal Color LCD Touchscreen
Display Resolution	800 x 480 Pixels
Supply Voltage	24VDC
Max. Current Consumption	320mA@24V
Number of Analog Inputs	9
Number of Analog Outputs	2
Number of Digital Inputs	18
Number of Digital Outputs	17
Onboard Communications	Modbus Protocol (Optional Gateways for BACnet, LonWorks, and CANbus)
Ethernet Port	RJ45 port capable of transmitting data 10/100Mbps
Additional Ports	2.0 USB Port; Micro-SD Port

Motor Data

Power Supply	208-230, 460, 575-3
Motor Enclosure	Totally Enclosed Fan Cooled (TEFC)
Motor Efficiency	Nema Premium Efficiency - Meets NEMA 12-12 Rule
Enclosure Construction	Rolled Steel / Cast Iron
Motor Protection Index	IP54
Insulation Class	F

Approval Stamp

Submittal Data Sheet

Wilo CO-Helix - NSF 61/372 Pressure Boosting System



CO-4 HELIX V80-06-1/10/VCE

208-230 V~3

460 V~3

575 V~3

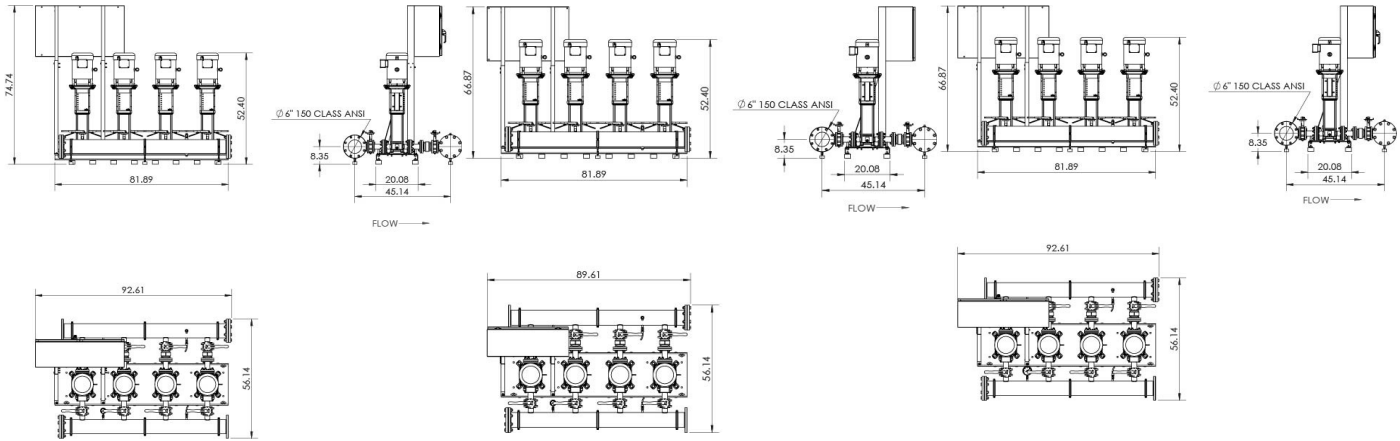

Special Note: All weights and dimensions are approximate and should not be used as exact rough-in dimensions

Dimensions and Weights

Model	Voltage (V)	H (in)	W (in)	L (in)	System Header Size	Dimensions-inches				Individual Pump Weight	Package Weight
						Suction / Discharge Pump Size (300 Class ANSI)	Gauge Tap Size	Transducer Tap Size	Hydronumatic Tank Valve on Manifold (Plugged)	Pump Weight (lbs)	Package Weight (lbs)
CO-4 HELIX V80-06-1/10/VCE	208-230 V	74-3/4	92-2/3	56-1/5	6" 150 ANSI Class	2"	1/4" FNPT	1/4" FNPT	3/4" MNPT x 3/4" FNPT	144	1,732
	460 V	66-7/8	89-2/3	56-1/5							
	575 V	66-7/8	92-2/3	56-1/5							

TEFC Motor Data

Model	P2	Phase	Voltage	FLA (per pump)	System FLA	Pmax
	(HP)	(-)	(V)	(A)		(PSI)
CO-4 HELIX V80-06-1/10/VCE	10	3	208-230/460/575	24.8-24.2/12.1/9.5	114.2-97/57/46.6	232