

Pioneering for You

Recirculation pump

EMU RZP 50-3.48-4/24 S25

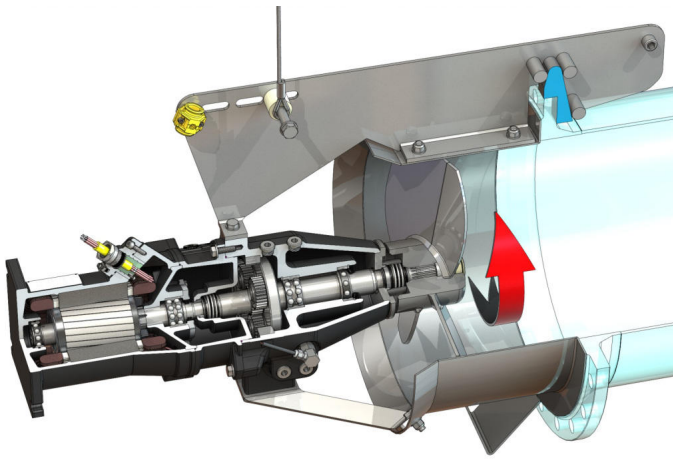

Unit

Max. weight* <i>m</i>	363.8 lb
Explosion protection ATEX ATEX	optional
Explosion protection FM FM	optional
Protection class motor	IP68

Propeller

Propeller model	3-blade propeller with self-cleaning hub; clogging- and entwining-free
Nominal propeller diameter <i>D_{nom}</i>	18.9 in (*)
Propeller speed <i>n</i>	480 RPM
Transmission ratio	3.600

Filling quantities and types

Filling prechamber	Gear oil CLP220
Filling volume prechamber <i>V</i>	0.3 US gal
Filling gear chamber	Gear oil CLP220
Fill volume gear chamber <i>V</i>	0.1 US gal
Filling sealing chamber	White oil
Fill volume sealing chamber <i>V</i>	0.3 US gal

Motor/electronics

Motor type	T 17-4/24R (Ex)
Motor design	Submersible motor – surface-cooled
Mains connection	3~460 V, 60 Hz
Rated current <i>I_N</i>	21.00 A
Starting current – direct <i>I_A</i>	110.00 A
Starting current – star-delta <i>I_A</i>	37.00 A
Power consumption <i>P_{1 max}</i>	18.9 hp
Rated power <i>P₂</i>	15.4 hp
Speed original <i>n</i>	1700 RPM
Motor efficiency class	–
Efficiency η_M	82.0 %
Power factor <i>cos φ</i>	0.85
Min. fluid temperature <i>T_{min}</i>	37 °F
Max. fluid temperature <i>T_{max}</i>	104 °F
Max. immersion depth	66 ft
Insulation class	H
Max. switching frequency <i>t</i>	15 rph
min. switching break <i>t</i>	3 min
Starting torque <i>M</i>	110.6 lbf ft
Moment of inertia	0.32 lb ft ²
Motor bearings	1 grooved ball bearing, 1 two-row inclined ball bearing

Materials

Motor housing	ASTM A48, Class No. 35
Static gaskets	FKM Fluoro rubber
Motor shaft	AISI 420
Seal, gear/sealing chamber	SiC/SiC, Q1Q1VGG
Gear housing	ASTM A48, Class No. 35
Planetary gear	AISI 5115
Hollow gear	Grade 60
Sun gear	AISI 5115
Output shaft	AISI 329
Seal, gear chamber/prechamber	FKM Fluoro rubber
Sealing chamber	ASTM A48, Class No. 35
Seal bushing	AISI 316Ti
Propeller hub	AISI 316Ti
Propeller	AISI 316Ti
Flow housing	AISI 316Ti

Gear

Gear construction type	m 2.0 as per DIN 780-1:1977-05 /P10 (ISO54-1996-12); sun and planetary gears case hardened and sanded, internal gear butt-jointed
Gear bearings	Three needle roller bearing (planetary), one two-row inclined ball bearing and one grooved ball bearing (output shaft)
Service life <i>L_{h10}</i>	100,000 operating hours, ISO 281:2007-02

*maximum weight including accessories