

Pioneering for You

wilo

Recirculation Pump

EMU RZP 80-2.18-6/22 S27

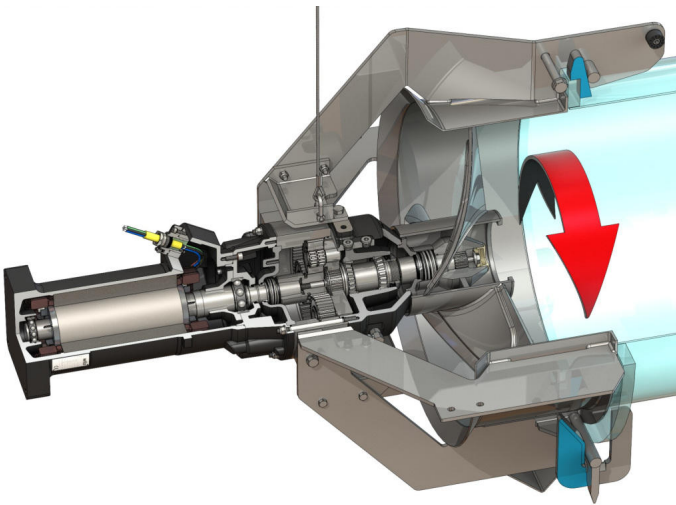

Unit

Max. weight* <i>m</i>	415 kg
Explosion protection <i>ATEX</i>	optional
Explosion protection <i>FM</i>	optional
Protection class motor	IP68

Propeller

Propeller model	4-blade propeller with self-cleaning hub; backward-curved as a result clogging- and entwining-free
Nominal propeller diameter	785 mm
Propeller speed <i>n</i>	180 1/min
Transmission ratio	5.286

Filling quantities and types

Filling prechamber	Gear oil CLP220
Filling volume prechamber <i>V</i>	2.00 l
Filling gear chamber	Gear oil CLP220
Fill volume gear chamber <i>V</i>	1.10 l
Filling sealing chamber	White oil
Fill volume sealing chamber <i>V</i>	2.00 l

Motor/electronics

Motor type	T 20-6/22R (Ex)
Motor design	Submersible motor acc. IEC 60034-1
Mains connection	3~400 V, 50 Hz
Rated current <i>I_N</i>	19.40 A
Starting current - direct <i>I_A</i>	97.00 A
Starting current - star-delta <i>I_A</i>	33.00 A
Power consumption <i>P_{1 max}</i>	11.20 kW
Rated power <i>P₂</i>	9.00 kW
Speed original <i>n</i>	930 1/min
Motor efficiency class	-
Efficiency η_M	81.0 %
Power factor <i>cos φ</i>	0.83
Min. fluid temperature <i>T</i>	3 °C
Max. fluid temperature <i>T</i>	40 °C
Max. immersion depth	20 m
Insulation class	H
Max. switching frequency <i>t</i>	15 1/h
min. switching break <i>t</i>	3 min
Starting torque <i>M</i>	175 Nm
Moment of inertia	0.05870 kg/m ²
Motor bearings	1 grooved ball bearing, 1 two-row inclined ball bearing

Materials

Motor housing	5.1301, EN-GJL-250
Static gaskets	FKM
Motor shaft	1.4021, X20Cr13
Seal on motor side	NBR Nitrile rubber
Seal, gear/sealing chamber	SiC/SiC, Q1Q1VGG
Gear housing	5.1301, EN-GJL-250
Planetary gear	1.7131, 16MnCr5
Hollow gear	1.5216, 17MnV6
Sun gear	1.7131, 16MnCr5
Output shaft	1.4462, X2CrNiMoN22-5-3
Seal, gear chamber/prechamber	FKM
Sealing chamber	5.1301, EN-GJL-250
Seal on the fluid side	SiC/SiC, Q1Q1VGG
Seal bushing	1.4571, X6CrNiMoTi17-12-2
Propeller hub	1.4571, X6CrNiMoTi17-12-2
Propeller	1.4571, X6CrNiMoTi17-12-2
Flow housing	1.4571, X6CrNiMoTi17-12-2

Gear

Gear construction type	m 3.0 as per DIN 780-1:1977-05 /P10 (ISO54: 1996-12); sun and planetary gears case hardened and sanded, internal gear butt-jointed
Gear bearings	3x2 needle roller bearing (planetary), two roller bearings (output shaft)
Service life <i>L_{h10}</i>	100,000 operating hours, ISO 281:2007-02

*maximum weight including accessories

Subject to change without prior notice