

Pioneering for You

wilo

## Recirculation Pump

EMU RZP 25-2.95-6/8 K2

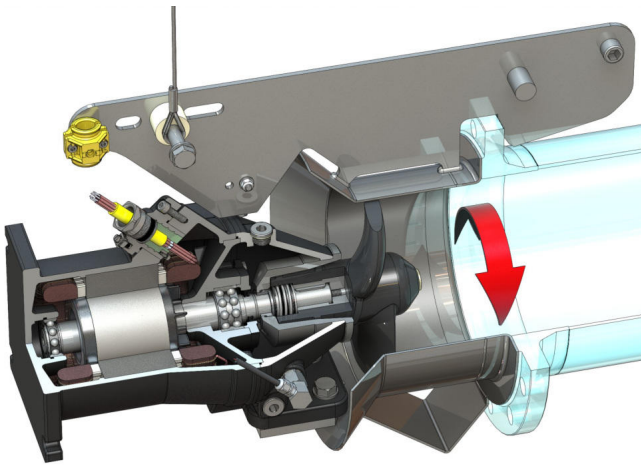

### Materials

Motor housing	5.1301, EN-GJL-250
Static gaskets	FKM
Motor shaft	1.4021, X20Cr13
Seal on motor side	FKM
Sealing chamber	5.1301, EN-GJL-250
Seal on the fluid side	SiC/SiC, Q1Q1VGG
Propeller hub	1.4571, X6CrNiMoTi17-12-2
Propeller	PUR Polyurethane
Flow housing	1.4571, X6CrNiMoTi17-12-2

### Unit

Max. weight* <i>m</i>	81 kg
Explosion protection ATEX	optional
Explosion protection FM	optional
Protection class motor	IP68

### Propeller

Propeller model	2-blade propeller with self-cleaning hub; backward-curved as a result clogging- and entwining-free
Nominal propeller diameter	250 mm
Propeller speed <i>n</i>	915 1/min
Transmission ratio	1.000

### Filling quantities and types

Filling sealing chamber	White oil
Fill volume sealing chamber <i>V</i>	1.10 l

### Motor/electronics

Motor type	T 17-6/8R (Ex)
Motor design	Submersible motor acc. IEC 60034-1
Mains connection	3~400 V, 50 Hz
Rated current $I_N$	4.45 A
Starting current - direct $I_A$	17.00 A
Starting current - star-delta $I_A$	6.00 A
Power consumption $P_{1 max}$	2.50 kW
Rated power $P_2$	1.75 kW
Speed original <i>n</i>	915 1/min
Motor efficiency class	-
Efficiency $\eta_M$	70.0 %
Power factor $\cos \varphi$	0.82
Min. fluid temperature <i>T</i>	3 °C
Max. fluid temperature <i>T</i>	40 °C
Max. immersion depth	20 m
Insulation class	H
Max. switching frequency <i>t</i>	15 1/h
min. switching break <i>t</i>	3 min
Starting torque <i>M</i>	37 Nm
Moment of inertia	0.01120 kg/m <sup>2</sup>
Motor bearings	1 grooved ball bearing, 1 two-row inclined ball bearing

\*maximum weight including accessories