

Pioneering for You

wilo

Recirculation Pump

EMU RZP 20.145-4/6 S5

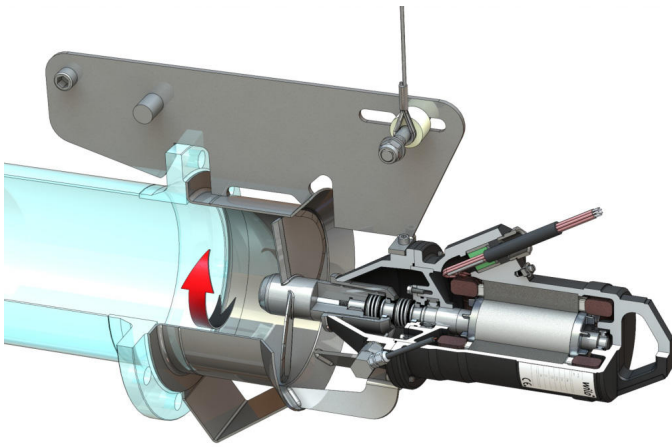

Materials

Motor housing	5.1301, EN-GJL-250
Static gaskets	FKM
Motor shaft	1.4021, X20Cr13
Seal on motor side	SiC/SiC, Q1Q1VGG
Sealing chamber	5.1301, EN-GJL-250
Seal on the fluid side	SiC/SiC, Q1Q1VGG
Propeller hub	1.4571, X6CrNiMoTi17-12-2
Propeller	1.4571, X6CrNiMoTi17-12-2
Flow housing	1.4571, X6CrNiMoTi17-12-2

Unit

Max. weight* <i>m</i>	37 kg
Explosion protection ATEX	optional
Explosion protection FM	optional
Protection class motor	IP68

Propeller

Propeller model	2-blade propeller with self-cleaning hub; backward-curved as a result clogging- and entwining-free
Nominal propeller diameter	200 mm
Propeller speed <i>n</i>	1336 1/min
Transmission ratio	1.000

Filling quantities and types

Filling sealing chamber	White oil
Fill volume sealing chamber <i>V</i>	0.35 l

Motor/electronics

Motor type	T 12-4/6G (Ex)
Motor design	Submersible motor acc. IEC 60034-1
Mains connection	3~400 V, 50 Hz
Rated current I_N	1.42 A
Starting current - direct I_A	6.00 A
Starting current - star-delta I_A	2.00 A
Power consumption $P_{1 max}$	0.73 kW
Rated power P_2	0.50 kW
Speed original <i>n</i>	1336 1/min
Motor efficiency class	-
Efficiency η_M	69.0 %
Power factor $\cos \varphi$	0.74
Min. fluid temperature <i>T</i>	3 °C
Max. fluid temperature <i>T</i>	40 °C
Max. immersion depth	20 m
Insulation class	H
Max. switching frequency <i>t</i>	15 1/h
min. switching break <i>t</i>	3 min
Starting torque <i>M</i>	3.5 Nm
Moment of inertia	0.01140 kg/m ²
Motor bearings	2 grooved ball bearing

*maximum weight including accessories