

## Wilo-Control EC-L



en Installation and operating instructions



Control EC-L  
<https://qr.wilo.com/1401>

## Table of contents

<b>1 General information</b> .....	<b>4</b>	8.5 Start initial configuration.....	32
1.1 About these instructions.....	4	8.6 Start automatic mode.....	45
1.2 Copyright.....	4	8.7 During operation.....	46
1.3 Subject to change.....	4	<b>9 Shut-down</b> .....	<b>47</b>
1.4 Exclusion from warranty and liability.....	4	9.1 Personnel qualifications.....	47
<b>2 Safety</b> .....	<b>4</b>	9.2 Operator responsibilities.....	47
2.1 Identification of safety instructions.....	4	9.3 Shut-down.....	48
2.2 Personnel qualifications.....	5	9.4 Removal.....	48
2.3 Electrical work.....	6	<b>10 Maintenance and repair</b> .....	<b>48</b>
2.4 Monitoring devices.....	6	10.1 Maintenance intervals.....	49
2.5 Installing/dismantling.....	6	10.2 Maintenance tasks.....	49
2.6 During operation.....	6	10.3 Maintenance interval display.....	49
2.7 Maintenance tasks.....	6	<b>11 Faults, causes and remedies</b> .....	<b>50</b>
2.8 Operator responsibilities.....	7	11.1 Operator responsibilities.....	50
<b>3 Application/use</b> .....	<b>7</b>	11.2 Fault indication.....	50
3.1 Intended use.....	7	11.3 Fault acknowledgement.....	50
3.2 Improper use.....	7	11.4 Fault memory.....	51
<b>4 Product description</b> .....	<b>7</b>	11.5 Error codes.....	51
4.1 Structure.....	7	11.6 Further steps for troubleshooting.....	52
4.2 How it works.....	7	<b>12 Disposal</b> .....	<b>52</b>
4.3 Operating modes.....	7	12.1 Rechargeable battery.....	52
4.4 Technical data.....	8	12.2 Information on the collection of used electrical and electronic products.....	53
4.5 Inputs and outputs.....	8	<b>13 Appendix</b> .....	<b>53</b>
4.6 Type key.....	9	13.1 Potentially explosive atmospheres: Connection of signal transmitters and pumps.....	53
4.7 Operation on electronic start-up controllers.....	9	13.2 System impedances.....	55
4.8 Installation in potentially explosive atmospheres.....	9	13.3 Overview of the symbols.....	55
4.9 Scope of delivery.....	9	13.4 Terminal diagram overview.....	56
4.10 Accessories.....	9	13.5 ModBus: Data types.....	57
<b>5 Transportation and storage</b> .....	<b>9</b>	13.6 ModBus: Parameter overview.....	57
5.1 Delivery.....	9		
5.2 Transport.....	10		
5.3 Storage.....	10		
<b>6 Installation</b> .....	<b>10</b>		
6.1 Personnel qualifications.....	10		
6.2 Installation types.....	10		
6.3 Operator responsibilities.....	10		
6.4 Installation.....	10		
6.5 Electrical connection.....	13		
<b>7 Operation</b> .....	<b>25</b>		
7.1 How it works.....	25		
7.2 Operating modes.....	27		
7.3 Menu control.....	29		
7.4 Menu type: Main menu or Easy Actions menu.....	29		
7.5 Call up the menu.....	29		
7.6 Quick access to “Easy Actions”.....	29		
7.7 Factory settings.....	30		
<b>8 Commissioning</b> .....	<b>30</b>		
8.1 Operator responsibilities.....	30		
8.2 Commissioning in explosive atmospheres.....	30		
8.3 Connection of signal transmitters and pumps within potentially explosive atmospheres.....	31		
8.4 Activating the device.....	31		

## 1 General information

### 1.1 About these instructions

These instructions form part of the product. Compliance with the instructions is essential for correct handling and use:

- Read the instructions carefully before all activities.
- Keep the instructions in an accessible place at all times.
- Observe all product specifications.
- Observe the markings on the product.

The language of the original operating instructions is German. All other languages of these instructions are translations of the original operating instructions.

### 1.2 Copyright

WILO SE © 2022

The reproduction, distribution and utilization of this document as well as the communication of its contents to others without express authorization is prohibited. Offenders will be held liable for the payment of damages. All rights reserved.

### 1.3 Subject to change

Wilo shall reserve the right to change the listed data without notice and shall not be liable for technical inaccuracies and/or omissions. The illustrations used may differ from the original and are intended as an example representation of the device.

### 1.4 Exclusion from warranty and liability

Wilo shall specifically not assume any warranty or liability in the following cases:

- Inadequate configuration due to inadequate or incorrect instructions by the operator or the client
- Non-compliance with these instructions
- Improper use
- Incorrect storage or transport
- Incorrect installation or dismantling
- Insufficient maintenance
- Unauthorised repairs
- Inadequate construction site
- Chemical, electrical or electrochemical influences
- Wear

## 2 Safety

This chapter contains basic information for the individual phases of the life cycle. Failure to observe this information carries the following risks:

- Risk of personal injury from electrical, electromagnetic or mechanical influences
- Environmental damage from discharge of hazardous substances
- Damage to property
- Failure of important functions

Failure to observe the information contained herein will result in the loss of claims for damages.

**The instructions and safety instructions in the other chapters must also be observed!**

### 2.1 Identification of safety instructions

These installation and operating instructions set out safety instructions for preventing personal injury and damage to property, which are displayed in different ways:

- Safety instructions relating to personal injury start with a signal word and are **preceded by a corresponding symbol**.



## DANGER

### Type and source of the danger!

Consequences of the danger and instructions for avoidance.

- Safety instructions relating to property damage start with a signal word and are displayed **without** a symbol.

---

## CAUTION

### Type and source of the danger!

Consequences or information.

---

### Signal words

- **Danger!**  
Failure to observe safety instructions will result in serious injury or death!
- **Warning!**  
Failure to follow instructions can lead to (serious) injury!
- **Caution!**  
Failure to follow instructions can lead to property damage and possible total loss.
- **Notice!**  
Useful information on handling the product

### Markups

- ✓ Prerequisite
- 1. Work step/list
  - ⇒ Notice/instructions
  - ▶ Result

### Symbols

These instructions use the following symbols:



Danger of electric voltage



Danger – explosive atmosphere



Useful information

## 2.2 Personnel qualifications

- Personnel have been instructed on locally applicable regulations governing accident prevention.
- Personnel have read and understood the installation and operating instructions.
- Electrical work: qualified electrician  
Person with appropriate technical training, knowledge and experience who can identify and prevent electrical hazards.
- Installation/dismantling work: qualified electrician  
Knowledge regarding tools and fixation material for various structures

## 2.3 Electrical work

- Operation/control: Operating personnel, instructed in the functioning of the complete system
- Electrical work must be carried out by a qualified electrician.
- Before commencing work, disconnect the product from the mains and safeguard it from being switched on again.
- Observe applicable local regulations when connecting to the mains power supply.
- Adhere to the requirements of the local energy supply company.
- Earth the product.
- Observe technical information.
- Replace a defective connection cable immediately.

## 2.4 Monitoring devices

### Circuit breaker

The size and switching characteristics of the circuit breakers must conform to the rated current of the connected consumer. Observe local regulations.

## 2.5 Installing/dismantling

- Locally applicable laws and regulations on work safety and accident prevention must be complied with.
- Disconnect the product from the mains and secure it against being switched on again.
- Suitable fixation material must be used for the existing bearing surface.
- The product is not watertight. Select an appropriate installation site!
- Do not deform the housing during installation. Seals could leak and affect the stated IP protection class.
- The product may **not** be installed in potentially explosive areas.

## 2.6 During operation

- The product is not watertight. Comply with protection class IP54.
- Ambient temperature: -30 ... +50 °C.
- Maximum humidity: 90 %, non-condensing.
- Do not open the switchgear.
- The user must notify the person in charge of every fault or irregularity immediately.
- In case of damage to the product or connection cable, switch off the product immediately.

## 2.7 Maintenance tasks

- Do not use any aggressive cleaners or scouring agents or fluids.
- The product is not watertight. Do not submerge the product in fluids.
- Only carry out maintenance tasks mentioned in these installation and operating instructions.

## 2.8 Operator responsibilities

- Only original parts from the manufacturer may be used for maintenance and repairs. Use of parts other than the original parts releases the manufacturer from any liability.
- Provide installation and operating instructions in a language which the personnel can understand.
- Make sure that the personnel has had the corresponding training for the specified work.
- Safety and information signs mounted on the device must always be legible.
- Train the personnel on how the system operates.
- Eliminate risk from electrical current.
- To ensure safe working practice, define personnel responsibilities.

Children and persons younger than 16 years or with reduced physical, sensory or mental capacities or limited experience are prohibited from handling the product! A technician must supervise persons younger than 18 years!

## 3 Application/use

### 3.1 Intended use

The switchgear is designed for level-dependent control of up to three pumps.

Intended use also includes compliance with this manual. Any other use is regarded as non-compliant with the intended use.

### 3.2 Improper use

- Installation in potentially explosive atmospheres
- Overflow of the switchgear

## 4 Product description

### 4.1 Structure

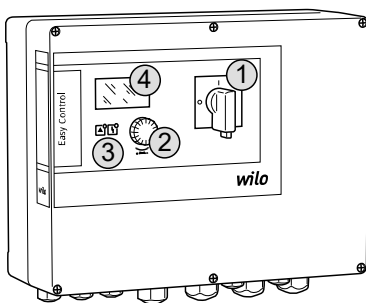

Fig. 1: Switchgear front

1	Main switch
2	Operating button
3	LED indicators
4	LCD display

The front of the switchgear comprises the following main components:

- Main switch for switching the switchgear on/off (not the “EMS” version)
- Operating button for menu selection and parameter input
- LEDs for displaying the current operating state
- LCD display for showing the current operating data and individual menu items

### 4.2 How it works

Level measurement is via a two-position control for each pump. The pumps are individually switched on/off automatically, depending on the fill level. An optical signal is given upon reaching the dry run or high water level. All pumps are also switched on or off by force. Faults are stored in the fault memory.

The current operating data and operating conditions are shown on the LCD display and indicated by LEDs. Operation and input of operating parameters is carried out using a rotary knob.

**NOTICE! Control EC-L3 ...: A max. of 2 pumps can be actuated with level measurement using a float switch!**

### 4.3 Operating modes

The switchgear has two different operating modes:

- drain (drain)
- fill (fill)

Selection is via the menu.

#### “Drain” operating mode

The reservoir or pump chamber is drained. The connected pumps are activated when the level rises and switched off when the level falls.

#### “Fill” operating mode

The reservoir is filled. The connected pumps are activated when the level falls and switched off when the level rises.

## 4.4 Technical data

Date of manufacture*	See rating plate
Mains connection	1~220/230 V, 3~380/400 V
Mains frequency	50/60 Hz
Max. current consumption per pump	12 A
Max. rated power per pump	4 kW
Pump activation type	Direct on line
Ambient/operating temperature	-30 ... +50 °C
Storage temperature	-30 ... +60 °C
Max. relative humidity	90 %, non-condensing
Protection class	IP54
Electrical safety	Pollution degree II
Control voltage	24 V =/~
Housing material	UV-resistant polycarbonate

Details about the Hardware version (HW) and Software version (SW) can be found on the rating plate!

\*The date of manufacture is stated in accordance with ISO 8601: JJJJWww

- JJJJ = year
- W = abbreviation for week
- ww = calendar week

## 4.5 Inputs and outputs

Inputs	Hardware version	Number of inputs		
		EC-L1 ...	EC-L2 ...	EC-L3 ...
<b>Level measurement</b>				
Level sensor	all	1	1	1
Float switch	all	2	3	3
Electrode	From HW 2	2	3	–
Dynamic pressure bell	all	1	1	1
<b>High water level</b>				
Float switch	all	1	1	1
Electrode	From HW 2	1	1	–
<b>Dry run/low water level</b>				
Float switch	all	1	1	1
Electrode	From HW 2	1	1	–
<b>Pump monitoring</b>				
Thermal winding monitor (bimetal)	all	1	2	3
Thermal winding monitor (PTC)	all	–	–	–
(Electrode) leakage detection	all	1	2	3
<b>Other inputs</b>				
Extern OFF: for remote switch off of all pumps In “fill” operating mode, dry-running protection is realised via this input.	all	1	1	1



Outputs	Hardware version	Number of inputs		
		EC-L1 ...	EC-L2 ...	EC-L3 ...
<b>Potential-free contacts</b>				
Collective fault signal (changeover contact)	all	1	1	1
Collective run signal (changeover contact)	all	1	1	1
Individual fault signal (closed contact (NC))	all	1	2	3
Individual run signal (open contact (NO))	all	1	2	3
<b>Other outputs</b>				
Service output (connection value: 24 V~, max. 4 VA) E.g. output for connecting an external alarm signal (lamp or horn)	all	1	1	1
Display of the current level value (0 ... 10 V=)	all	1	1	1

#### 4.6 Type key

##### Example: Wilo-Control EC-L 2x12A-MT34-DOL-WM-X

EC	Easy Control switchgear for fixed-speed pumps
L	"Lift" version for water lifting applications
2x	Max. number of pumps that can be connected
12A	Max. rated current per pump in amperes
MT34	Mains connection: <ul style="list-style-type: none"> <li>M = single-phase current (1~220/230 V)</li> <li>T34 = three-phase current (3~380/400 V)</li> </ul>
DOL	Pump activation type: Direct
WM	Wall fixation
X	Versions: <ul style="list-style-type: none"> <li>EMS = without main switch (mains isolator must be provided by the customer!)</li> <li>IPS = with integrated pressure transducer for direct connection of a dynamic pressure bell</li> </ul>

#### 4.7 Operation on electronic start-up controllers

Connect the switchgear directly to the pump and the mains. Intermediate switching of additional electronic start-up controllers, e.g. a frequency converter, is not permitted!

#### 4.8 Installation in potentially explosive atmospheres

The switchgear does not have its own explosion protection class. **Do not** install the switchgear in potentially explosive areas!

#### 4.9 Scope of delivery

- Switchgear
- Installation and operating instructions

#### 4.10 Accessories

- Float switch for drainage and sewage
- Level sensor 4 ... 20 mA
- Level monitor
- Dynamic pressure bell and bubbling-through system
- Signal lamp 24 V DC
- Flash light 230 V~
- Horn 230 V~
- Rechargeable battery for mains-independent alarm
- Ex cut-off relay
- Zener barrier

## 5 Transportation and storage

### 5.1 Delivery

After receiving the shipment, check it immediately for defects (damage, completeness). The transport company or the manufacturer must be notified of any defects the day the shipment is received, and the damage noted on the freight documentation. Claims cannot be asserted if the notification of defects takes place at a later date.

## 5.2 Transport

### CAUTION

#### Soaked packaging may tear!

The product may fall on the ground if unprotected and may be damaged. Lift wet packaging carefully and replace it immediately!

## 5.3 Storage

- Clean switchgear.
- Close housing apertures, ensuring they are sealed watertight.
- Impact-resistant and watertight packaging.
- Pack the switchgear in dustproof and watertight packaging.
- Storage temperature: -30 ... +60 °C, max. relative humidity: 90 %, non-condensing.
- Frost-proof storage at a temperature of 10 °C to 25 °C with relative humidity of 40 ... 50 % is recommended.
- Avoid the formation of condensation at all times!
- All open threaded cable glands must be sealed to prevent water ingress into the housing.
- Attached cables should be protected against kinking, damage, and ingress of moisture.
- To prevent damage to the components, protect the switchgear from direct sunlight and heat.
- Clean the switchgear after storage.
- If there has been water ingress or condensation has formed, have all the electronic components tested for correct function. Contact customer service!

## 6 Installation

### 6.1 Personnel qualifications

- Check the switchgear for damage caused during transport. Do **not** install defective switchgears!
- Observe the local guidelines for the design and operation of electronic controls.
- Electrical work: qualified electrician  
Person with appropriate technical training, knowledge and experience who can identify and prevent electrical hazards.
- Installation/dismantling work: qualified electrician  
Knowledge regarding tools and fixation material for various structures

### 6.2 Installation types

- Wall fixation

### 6.3 Operator responsibilities

- The installation location is clean, dry and free of vibration.
- The installation location is overflow-proof.
- The switchgear is not exposed to direct sunlight.
- Installation location outside of potentially explosive atmospheres.

### 6.4 Installation



#### DANGER

#### Risk of explosion if the switchgear is installed in potentially explosive areas!

The switchgear does not have its own explosion protection class and must always be installed outside of potentially explosive areas! The connection must be made by a qualified electrician.

- Level sensor and connection cable provided by the customer.
- While laying the cables, ensure that there is no tension, no kinking and no pinching that could damage the cable.
- Check the cable cross-section and length for the routing type chosen.
- Seal unused threaded cable glands.
- Ensure that the following ambient conditions are adhered to:
  - Ambient/operating temperature: -30 ... +50 °C
  - Relative humidity: 40 ... 50 %
  - Max. relative humidity: 90 %, non-condensing

#### 6.4.1 Basic advice on fixing the switchgear in place

Various structures can be used for installation (concrete wall, mounting rail, etc.). For this reason, the fixation material for the relevant construction must be provided by the customer and the following information must be observed:

- To prevent cracks in the masonry and chipping of the construction material, ensure sufficient clearance to the edge of the structure.
- The depth of the borehole depends on the length of the screws. Drill the borehole approx. 5 mm deeper than the screw length.
- Drilling dust impairs retention force. Always blow the borehole clean or vacuum it out.
- Do not damage the housing during installation.

#### 6.4.2 Installation of switchgear

Attach the switchgear to the wall with the four screws and wall plugs.

- Max. screw diameter:
    - Control EC-L 1x.../EC-L 2x...: 4 mm
    - Control EC-L 3x...: 6 mm
  - Max. screw head diameter:
    - Control EC-L 1x.../EC-L 2x...: 7 mm
    - Control EC-L 3x...: 11 mm
  - ✓ Switchgear is disconnected from the mains and voltage-free.
1. Align the drill template at the installation location and attach.
  2. Drill and clean the mounting holes in accordance with the specifications of the fixation material.
  3. Remove the drill template.
  4. Loosen the screws on the cover and remove the cover to the side.
  5. Attach the lower part to the wall with the fixation material.  
Check the lower part for deformations! Realign deformed housing covers (e.g. by placing alignment plates below them) to ensure the housing cover closes precisely. **NO-TICE! If the cover does not close correctly, the protection class is compromised!**
  6. Close the cover and fasten it with the screws.
    - ▶ The switchgear is installed. Now connect the mains, pumps and signal transmitter.

#### 6.4.3 Level control

For automatic control of the pumps, a level control device must be installed. To this end, the following signal transmitters can be connected:

- Level sensor  
Change the switching points via the menu.
- Dynamic pressure bell  
**Only "IPS" version!** Change the switching points via the menu.
- Float switch
- Electrode
  - **Only** Control EC-L1 ... and EC-L2 ...
  - Hardware version 2 **or higher**
- Level monitor

The signal transmitters must be installed according to the system's installation plan. Please observe the following points:

- Float switch: Float switches must be able to move freely in the operating space (pump chamber, tank)!
- Dynamic pressure bell: Install a bubbling-through system to optimally vent the dynamic pressure bell.
- Do **not undercut** the minimum water level of the pumps!
- Do **not exceed** the switching frequency of the pumps!

#### 6.4.4 Dry-running protection

The level can be measured via the following signal transmitters:

- Level sensor  
Set the switching point in the menu.
- Dynamic pressure bell  
**Only "IPS" version!** Set the switching point in the menu.
- Separate float switch
- Separate electrode
  - **Only** Control EC-L1 ... and EC-L2 ...
  - Hardware version 2 **or higher**

A **forced switch-off** of all pumps always takes place in the event of an alarm, irrespective of the selected signal transmitter!

The signal transmitters must be installed according to the system's installation plan. Please observe the following points:

- Float switch: Float switches must be able to move freely in the operating space (pump chamber, tank)!
- Dynamic pressure bell: Install a bubbling-through system to optimally vent the dynamic pressure bell.

**The following applies to the “fill” operating mode:**

- Implement dry-running protection in all cases via the “Extern OFF” input!
- Install the signal transmitter in the supplying tank (e.g. well).

#### 6.4.5 Water shortage (for “fill” operating mode only)

The level can be measured via the following signal transmitters:

- Level sensor  
Set the switching point in the menu.
- Dynamic pressure bell  
**Only “IPS” version!** Set the switching point in the menu.
- Separate float switch
- Separate electrode
  - **Only** Control EC-L1 ... and EC-L2 ...
  - Hardware version 2 **or higher**

A **forced switch-on** of all pumps always takes place in the event of an alarm, irrespective of the selected signal transmitter!

The signal transmitters must be installed according to the system's installation plan. Please observe the following points:

- Float switch: Float switches must be able to move freely in the operating space (pump chamber, tank)!
- Dynamic pressure bell: Install a bubbling-through system to optimally vent the dynamic pressure bell.

#### 6.4.6 High water alarm

The level can be measured via the following signal transmitters:

- Level sensor  
Set the switching point in the menu.
- Dynamic pressure bell  
**Only “IPS” version!** Set the switching point in the menu.
- Separate float switch
- Separate electrode
  - **Only** Control EC-L1 ... and EC-L2 ...
  - Hardware version 2 **or higher**

The signal transmitters must be installed according to the system's installation plan. Please observe the following points:

- Float switch: Float switches must be able to move freely in the operating space (pump chamber, tank)!
- Dynamic pressure bell: Install a bubbling-through system to optimally vent the dynamic pressure bell.

**What to do in the event of an alarm**

- **Operating mode “drain”:** A **forced switch-on** of all pumps always takes place in the event of an alarm, irrespective of the selected signal transmitter!
- **Operating mode “fill”:** A **forced switch-off** of all pumps always takes place in the event of an alarm, irrespective of the selected signal transmitter!

The pumps must be activated for the **forced switch-on**:

- Menu 3.01: Pumps are enabled.
- Extern OFF: Function is inactive.

**DANGER****Risk of fatal injury due to electrical current!**

Improper conduct when carrying out electrical work can lead to death due to electric shock!

- Electrical work must be carried out by a qualified electrician!
- Observe local regulations!

**NOTICE**

- Depending on the system impedance and the maximum connections/hour of the connected consumers, voltage fluctuations and/or drops may occur.
- When using shielded cables, attach the shielding to the earth rail on one side of the switchgear!
- Always have connection carried out by a qualified electrician!
- Observe the installation and operating instructions for the connected pumps and signal transmitters.

- The mains connection current and voltage must be as stated on the rating plate.
- Execute fuse protection on the mains side in accordance with the local guidelines.
- If circuit breakers are used, the switching characteristics should be selected according to the connected pump.
- Follow local guidelines if residual-current devices (RCD, type A, sinusoidal current, universal-current-sensitive) are installed.
- Route connection cable in accordance with the local guidelines.
- Do not damage the connection cable during routing or installation.
- Earth the switchgear and all electrical consumers.

## 6.5.1 Overview of components

## Overview Control EC-L 1 ... /EC-L 2 ...

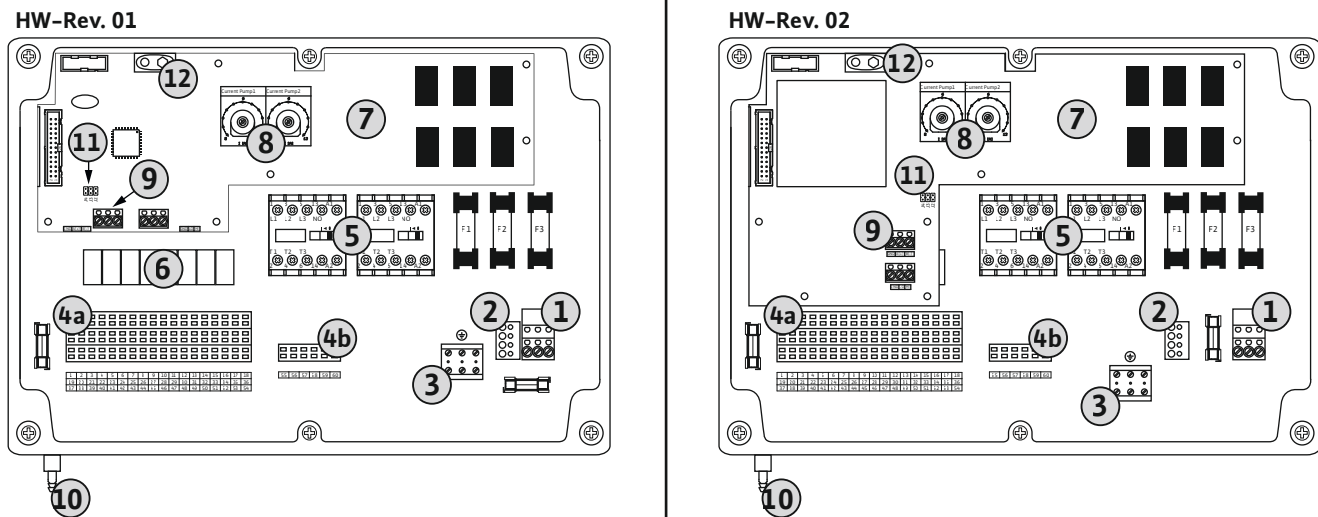

Fig. 2: Control EC-L 1 ... /EC-L 2 ...

1	Terminal strip: Mains connection
2	Mains voltage adjustment
3	Terminal strip: Earth (PE)
4a	Terminal strip: Sensors
4b	Terminal strip: Sensors for active ex-mode
5	Contactors combinations
6	Output relay
7	Control board
8	Potentiometer for motor current monitoring
9	ModBus RTU: RS485 interface
10	Dynamic pressure bell pressure connection ("IPS" version only)
11	ModBus RTU: Jumper for termination/polarisation
12	Slot 9 V rechargeable battery

## Overview Control /EC-L 3 ...

HW-Rev. 01 &amp; 02

■ = HW-Rev. 01

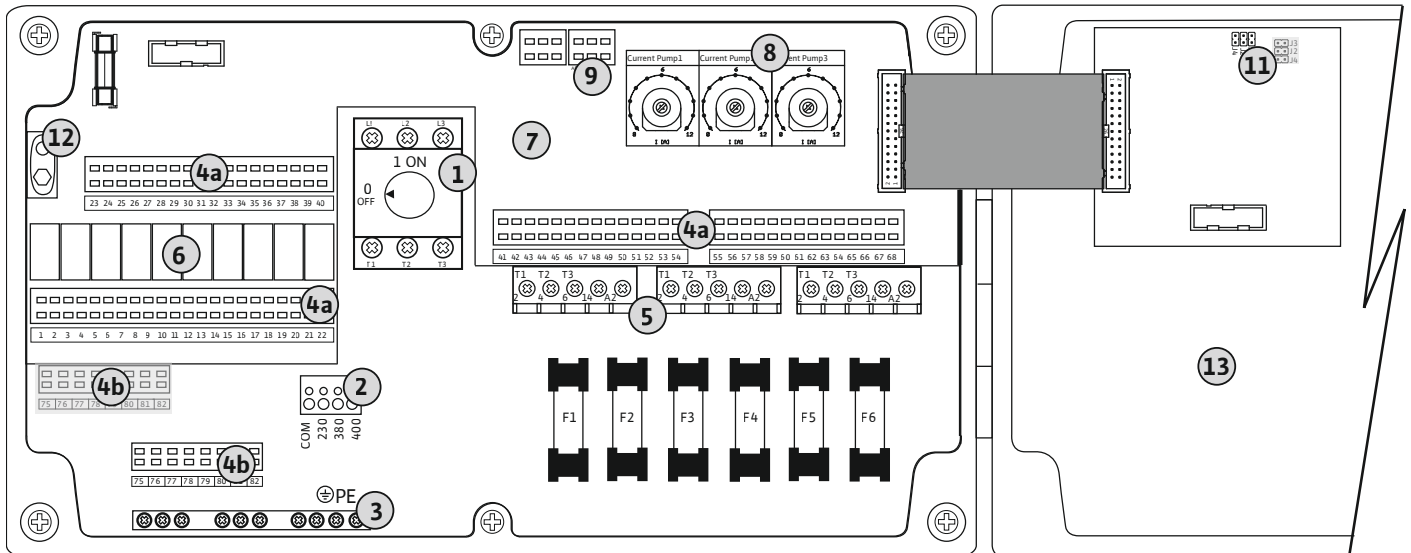

Fig. 3: Control EC-L 3 ...

1	Main switch/mains connection
2	Mains voltage adjustment
3	Terminal strip: Earth (PE)
4a	Terminal strip: Sensors
4b	Terminal strip: Sensors for active ex-mode
5	Contactor combinations
6	Output relay
7	Control board
8	Potentiometer for motor current monitoring
9	ModBus RTU: RS485 interface
11	ModBus RTU: Jumper for termination/polarisation
12	Slot 9 V rechargeable battery
13	Housing cover

## 6.5.2 Switchgear mains connection

**CAUTION****Material damage due to incorrectly set mains voltage!**

The switchgear can be operated at different mains voltages. The mains voltage is set to 400 V at the factory. To use another mains voltage, change the position of the cable jumper before connection. If the wrong mains voltage is set, the switchgear will be destroyed!

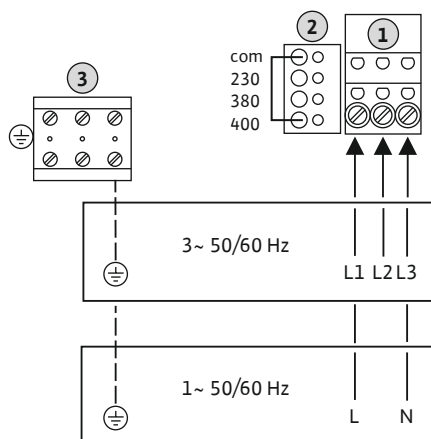

Fig. 4: Mains connection, Wilo-Control EC-L 1 ... /EC-L 2 ...

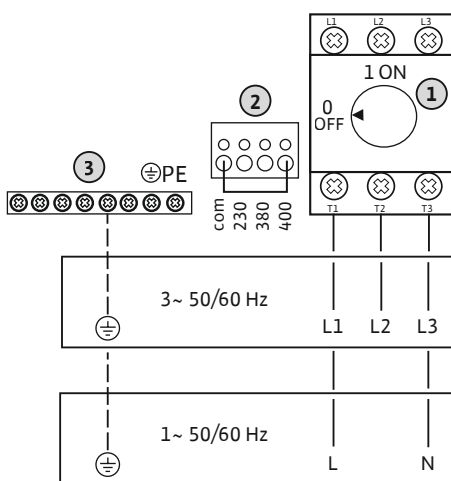

Fig. 5: Mains connection, Wilo-Control EC-L 3 ...

### 6.5.3 Mains connection, pump

#### Mains connection, Wilo-Control EC-L 1 ... /EC-L 2 ...

Insert the connection cables laid by the customer through the threaded cable glands and secure. Connect the wires to the terminal strip according to the connection diagram.

1	Terminal strip: Mains connection
2	Mains voltage adjustment
3	Terminal strip: Earth (PE)

##### Mains connection 1~230 V:

- Cable: 3-core
- Wire: L, N, PE
- Mains voltage adjustment: Converter bridge 230/COM

##### Mains connection 3~380 V:

- Cable: 4-core
- Wire: L1, L2, L3, PE
- Mains voltage adjustment: Converter bridge 380/COM

##### Mains connection 3~400 V:

- Cable: 4-core
- Wire: L1, L2, L3, PE
- Mains voltage adjustment: Converter bridge 400/COM (**factory setting**)

#### Mains connection, Wilo-Control EC-L 3 ...

Insert the connection cables laid by the customer through the threaded cable glands and secure. Connect the wires to the main switch as per the connection diagram.

1	Main switch
2	Mains voltage adjustment
3	Terminal strip: Earth (PE)

##### Mains connection 1~230 V:

- Cable: 3-core
- Wire: L, N, PE
- Mains voltage adjustment: Converter bridge 230/COM

##### Mains connection 3~380 V:

- Cable: 4-core
- Wire: L1, L2, L3, PE
- Mains voltage adjustment: Converter bridge 380/COM

##### Mains connection 3~400 V:

- Cable: 4-core
- Wire: L1, L2, L3, PE
- Mains voltage adjustment: Converter bridge 400/COM (**factory setting**)



#### NOTICE

##### Rotating field, power supply and pump connection

The rotating field is routed from the mains connection directly to the pump connection. Check the required rotating field of the pumps to be connected (clockwise or counter-clockwise)! Observe the installation and operating instructions of the pumps.



### 6.5.3.1 Connect pump(s)

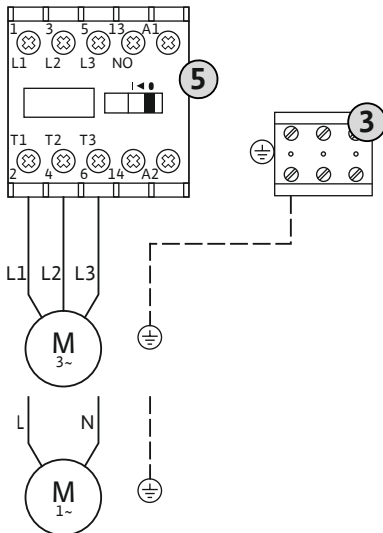

Fig. 6: Pump connection

### 6.5.3.2 Adjust motor current monitoring

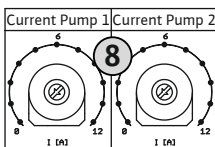

Fig. 7: Adjust motor current monitoring

### 6.5.4 Connection, thermal motor monitoring



#### DANGER

##### Risk of explosion due to incorrect connection!

If the connected pump is installed in an explosive atmosphere, there is a risk of explosion due to incorrect connection:

- Switch on ex-mode (menu 5.64)!
- Observe the section on explosive atmospheres in the appendix.
- Connection must be carried out by a qualified electrician.

3 Terminal strip: Earth (PE)

5 Contactor

Insert the connection cable laid by the customer through the threaded cable glands and secure. Connect the wires to the contactor as per the connection diagram.

**NOTICE! After all pumps have been connected, set the motor current monitoring!**

Set the permissible rated current after connecting the pump.

8 Potentiometer for motor current monitoring

Set the motor current on the respective potentiometer with a screwdriver:

- At full load, set the rated current in accordance with the rating plate.
- At partial load, set the rated current 5 % above the current measured at the duty point.

The motor current monitoring can be fine tuned during commissioning. The actual motor current can be displayed during commissioning:

- Currently **set** rated current of the motor monitoring (menu 4.25 ... 4.27)
- Currently **measured** operating current of the pump (menu 4.29 ... 4.31)



#### DANGER

##### Risk of explosion due to incorrect connection!

If the connected pump is installed in an explosive atmosphere, there is a risk of explosion due to incorrect connection:

- Switch on ex-mode (menu 5.64)!
- Observe the section on explosive atmospheres in the appendix.
- Connection must be carried out by a qualified electrician.

#### CAUTION

##### Do not apply external voltage!

An external voltage which is applied destroys the component.

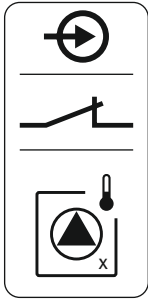

Fig. 8: Connection overview symbol

### 6.5.5 Leakage detection connection

One thermal motor monitoring device with bimetallic strips can be connected per pump. Do not connect a PTC sensor!

Insert the connection cables laid by the customer through the threaded cable glands and secure. Connect the wires to the terminal strip according to the connection diagram. **Use the terminal number shown in the connection overview on the cover.** The number shown in location “x” on the symbol indicates which pump it refers to:

- 1 = pump 1
- 2 = pump 2
- 3 = pump 3



#### DANGER

##### Risk of explosion due to incorrect connection!

If the connected pump is installed in an explosive atmosphere, there is a risk of explosion due to incorrect connection:

- Switch on ex-mode (menu 5.64)!
- Observe the section on explosive atmospheres in the appendix.
- Connection must be carried out by a qualified electrician.

#### CAUTION

##### Do not apply external voltage!

An external voltage which is applied destroys the component.

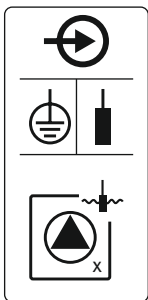

Fig. 9: Connection overview symbol

### 6.5.6 Connection of signal transmitter for level control device

Leakage detection that uses a moisture probe can be connected for each pump. The threshold (< 30 kOhm) for a deactivation is permanently stored in the switchgear. Do not connect a float switch!

Insert the connection cables laid by the customer through the threaded cable glands and secure. Connect the wires to the terminal strip according to the connection diagram. **Use the terminal number shown in the connection overview on the cover.** The number shown in location “x” on the symbol indicates which pump it refers to:

- 1 = pump 1
- 2 = pump 2
- 3 = pump 3



#### DANGER

##### Risk of explosion due to incorrect connection!

If the connected signal transmitter is installed in an explosive atmosphere (Ex zone), there is a risk of explosion due to incorrect connection:

- **Do not** connect electrode in an explosive atmosphere (Ex zone)!
- Connect the float switch using an Ex cut-off relay!
- Connect level sensor via a Zener barrier!
- Observe the section on explosive atmospheres in the appendix.
- Connection must be carried out by a qualified electrician.

#### CAUTION

##### Do not apply external voltage!

An external voltage which is applied destroys the component.

The level can be measured via the following signal transmitters:

- Level sensor

- Dynamic pressure bell
  - **Only “IPS” version!**
- Float switch
- Electrode
  - **Only** Control EC-L1 ... and EC-L2 ...
  - Hardware version 2 **or higher**
  - Connection is protected against reverse polarity!
- Level monitor

Insert the connection cables laid by the customer through the threaded cable glands and secure. Connect the wires to the terminal strip according to the connection diagram. **Use the terminal number shown in the connection overview on the cover.**

**Float switch or electrode**

**NOTICE! A max. of two pumps can be controlled if float switches or electrodes are used.**

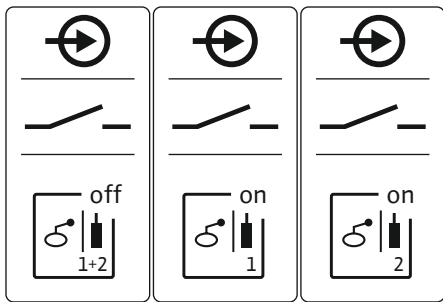

Fig. 10: Connection overview symbol

	Level, “All pumps Off”
	Level, “Pump 1 On”
	Level, “Pump 2 On”

**Level sensor**

- Connection load: 4 ... 20 mA
- **Do not** connect active level sensors.
- **NOTICE! Observe the correct polarity when connecting!**

**Dynamic pressure bell**

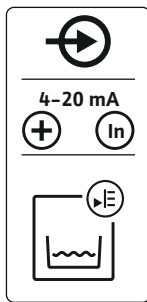

Fig. 11: Connection overview symbol

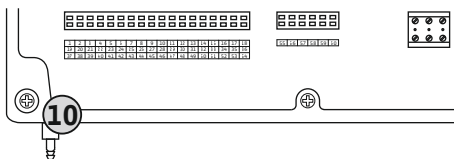

Fig. 12: Discharge connection

10	Dynamic pressure bell, pressure connection
----	--

- Connection load: 0 ... 250 mbar
  - Vent the dynamic pressure bell after each drainage process. If the dynamic pressure bell cannot be readily ventilated, vent the dynamic pressure bell with a compressor (bubbling-through system). Venting can take place continuously or periodically.
1. Loosen and unscrew the union nut from the discharge connection.
  2. Insert a union nut on the pressure hose of the dynamic pressure bell
  3. Push the pressure hose onto the pressure connection as far as it will go.
  4. Screw the union nut back onto the pressure connection and tighten it to fasten the pressure hose.

**6.5.7 Connection of the NW16 level monitor**



**DANGER**

**Risk of explosion if the level monitor is installed in potentially explosive areas!**

The NW16 level monitor does not have its own explosive protection class.

- The NW16 level monitor may only be installed outside potentially explosive atmospheres!

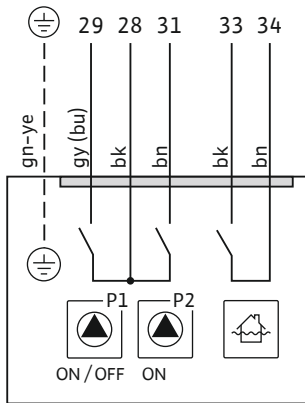

Fig. 13: Connection diagram NW16 at the control EC-L 2x...

#### 6.5.8 Connection dry-running protection/min. Water level with separate float switch



Fig. 14: Connection overview symbol

## CAUTION

### Do not apply external voltage!

An external voltage which is applied destroys the component.

The level detection for **two** pumps can be performed using the NW16 level monitor. The level monitor has the following switching points:

- Pump 1 On/Off
- Pump 2 On/Off
- High water alarm

The level control corresponds to operation with separate float switches. The internal structure of the level monitor ensures hysteresis between the activation/deactivation level of the relevant pump.

Insert the connection cables laid by the customer through the threaded cable glands and secure. Connect the wires to the terminal strip according to the connection diagram.



## DANGER

### Risk of explosion due to incorrect connection!

If the connected signal transmitter is installed in an explosive atmosphere (Ex zone), there is a risk of explosion due to incorrect connection:

- **Do not** connect electrode in an explosive atmosphere (Ex zone)!
- Connect the float switch using an Ex cut-off relay!
- Connect level sensor via a Zener barrier!
- Observe the section on explosive atmospheres in the appendix.
- Connection must be carried out by a qualified electrician.

## CAUTION

### Do not apply external voltage!

An external voltage which is applied destroys the component.

#### Dry-running protection ("drain" operating mode)

The dry-running level can also be monitored by the following signal transmitters:

- Float switch
- Electrode
  - **Only** Control EC-L1 ... and EC-L2 ...
  - Hardware version 2 **or higher**
  - Connection is protected against reverse polarity!

The input acts as a normally open contact (NO):

- Float switch open/electrode not immersed: Dry run
- Float switch closed/electrode immersed: No dry run

The terminals are fitted with a converter bridge at the factory.

**NOTICE! A separate dry-running protection system is recommended as an additional system safety measure.**

Insert the connection cables laid by the customer through the threaded cable glands and secure. Remove the converter bridge and connect the wires to the terminal strip according to the connection diagram. **Use the terminal number shown in the connection overview on the cover.**

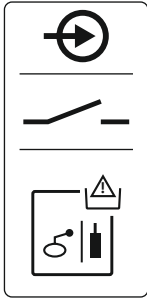

Fig. 15: Connection overview symbol

### 6.5.9 High water alarm connection with separate float switch

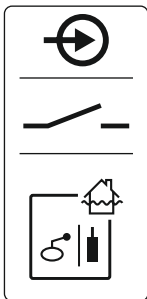

Fig. 16: Connection overview symbol

### 6.5.10 "Extern OFF" connection: Remote deactivation

#### Min. water level (operating mode "fill")

The min. water level can also be monitored by the following signal transmitters:

- Float switch
- Electrode
  - **Only** Control EC-L1 ... and EC-L2 ...
  - Hardware version 2 **or higher**
  - Connection is protected against reverse polarity!

The input acts as a normally open contact (NO):

- Float switch open/electrode not immersed: Min. water level
- Float switch closed/electrode immersed: water level sufficient

The terminals are fitted with a converter bridge at the factory.

Insert the connection cable laid by the customer through the threaded cable glands and secure. Remove the converter bridge and connect the wires to the terminal strip according to the connection diagram. **Use the terminal number shown in the connection overview on the cover.**



#### DANGER

##### Risk of explosion due to incorrect connection!

If the connected signal transmitter is installed in an explosive atmosphere (Ex zone), there is a risk of explosion due to incorrect connection:

- **Do not** connect electrode in an explosive atmosphere (Ex zone)!
- Connect the float switch using an Ex cut-off relay!
- Connect level sensor via a Zener barrier!
- Observe the section on explosive atmospheres in the appendix.
- Connection must be carried out by a qualified electrician.

#### CAUTION

##### Do not apply external voltage!

An external voltage which is applied destroys the component.

The high-water level can also be monitored by the following signal transmitters:

- Float switch
- Electrode
  - **Only** Control EC-L1 ... and EC-L2 ...
  - Hardware version 2 **or higher**
  - Connection is protected against reverse polarity!

The input acts as a normally open contact (NO):

- Float switch open/electrode not immersed: No high water alarm
- Float switch closed/electrode immersed: High water alarm

**NOTICE! A separate signal transmitter for the high water level is recommended as an additional system safety measure.**

Insert the connection cables laid by the customer through the threaded cable glands and secure. Connect the wires to the terminal strip according to the connection diagram. **Use the terminal number shown in the connection overview on the cover.**

#### CAUTION

##### Do not apply external voltage!

An external voltage which is applied destroys the component.

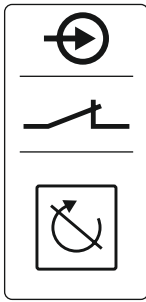

Fig. 17: Connection overview symbol

#### 6.5.11 Connection of a level actual value display

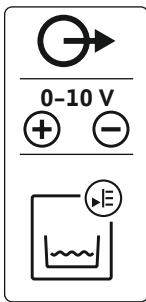

Fig. 18: Connection overview symbol

#### 6.5.12 Collective run signal (SBM) connection

Remote deactivation of all pumps can be performed using a separate signal transmitter:

- Float switch
- Electrode
  - **Only** Control EC-L1 ... and EC-L2 ...
  - Hardware version 2 **or higher**
  - Connection is protected against reverse polarity!

The input acts as a normally closed contact (NC):

- Float switch closed/electrode immersed: Pumps enabled
- Float switch open/electrode not immersed: all pumps deactivated – the display shows the “Extern OFF” symbol.

If the alarm is activated in menu 5.39, in the “fill” operating mode, an audible alarm sounds in addition to the symbol appearing.

The terminals are fitted with a converter bridge at the factory.

**NOTICE! Remote deactivation is prioritised. All pumps are deactivated independently of the level measurement. Manual mode and forced switch-on of the pumps is not possible!**

Insert the connection cables laid by the customer through the threaded cable glands and secure. Remove the converter bridge and connect the wires to the terminal strip according to the connection diagram. **Use the terminal number shown in the connection overview on the cover.**

### CAUTION

#### Do not apply external voltage!

An external voltage which is applied destroys the component.

The actual level value is exported via a separate output. A voltage of 0 ... 10 V= is provided for this at the output:

- 0 V = level sensor value “0”
  - 10 V = level sensor upper limit
- Example:
- Level sensor measurement range: 0 ... 2.5 m
  - Display range: 0 ... 2.5 m
  - Setting: 1 V = 0.25 m

Insert the connection cables laid by the customer through the threaded cable glands and secure. Connect the wires to the terminal strip according to the connection diagram. **Use the terminal number shown in the connection overview on the cover.**

Activate the function in menu 5.07 to output the actual level value.



### DANGER

#### Risk of fatal injury due to an external electrical power supply!

The external electrical power supply is also present at the terminals when the main switch is switched off! There is a risk of fatal injury!

- Disconnect external power supply before any work!
- Electrical work must be carried out by a qualified electrician!
- Observe local regulations!

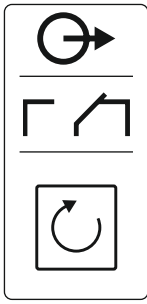

Fig. 19: Connection overview symbol

### 6.5.13 Collective fault signal connection (SSM)

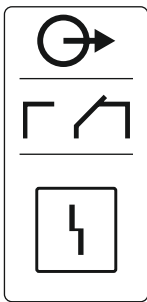

Fig. 20: Connection overview symbol

### 6.5.14 Individual run signal (EBM) connection

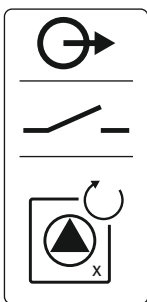

Fig. 21: Connection overview symbol

A run signal is issued for all pumps (SBM) via a separate output:

- Contact type: potential-free changeover contact
- Contact load:
  - Minimum: 12 V $\bar{=}$ , 10 mA
  - Maximum: 250 V $\sim$ , 1 A

Insert the connection cables laid by the customer through the threaded cable glands and secure. Connect the wires to the terminal strip according to the connection diagram. **Use the terminal number shown in the connection overview on the cover.**



## DANGER

### Risk of fatal injury due to an external electrical power supply!

The external electrical power supply is also present at the terminals when the main switch is switched off! There is a risk of fatal injury!

- Disconnect external power supply before any work!
- Electrical work must be carried out by a qualified electrician!
- Observe local regulations!

A fault message is output for all pumps (SSM) via a separate output:

- Contact type: potential-free changeover contact
- Contact load:
  - Minimum: 12 V $\bar{=}$ , 10 mA
  - Maximum: 250 V $\sim$  1 A

Insert the connection cables laid by the customer through the threaded cable glands and secure. Connect the wires to the terminal strip according to the connection diagram. **Use the terminal number shown in the connection overview on the cover.**



## DANGER

### Risk of fatal injury due to an external electrical power supply!

The external electrical power supply is also present at the terminals when the main switch is switched off! There is a risk of fatal injury!

- Disconnect external power supply before any work!
- Electrical work must be carried out by a qualified electrician!
- Observe local regulations!

A run signal is output for each pump (EBM) via a separate output:

- Contact type: potential-free NO contact
- Contact load:
  - Minimum: 12 V $\bar{=}$ , 10 mA
  - Maximum: 250 V $\sim$ , 1 A

Insert the connection cables laid by the customer through the threaded cable glands and secure. Connect the wires to the terminal strip according to the connection diagram. **Use the terminal number shown in the connection overview on the cover.** The number shown in location "x" on the symbol indicates which pump it refers to:

- 1 = pump 1
- 2 = pump 2
- 3 = pump 3

### 6.5.15 Individual fault signal (ESM) connection

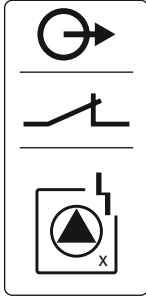

Fig. 22: Connection overview symbol

### 6.5.16 Connecting an external alarm signal

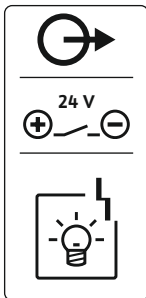

Fig. 23: Connection overview symbol

### 6.5.17 Installing the rechargeable battery



#### DANGER

##### Risk of fatal injury due to an external electrical power supply!

The external electrical power supply is also present at the terminals when the main switch is switched off! There is a risk of fatal injury!

- Disconnect external power supply before any work!
- Electrical work must be carried out by a qualified electrician!
- Observe local regulations!

A fault message is output for each pump (ESM) via a separate output:

- Contact type: potential-free NC contact
- Contact load:
  - Minimum: 12 V<sub>DC</sub>, 10 mA
  - Maximum: 250 V<sub>AC</sub>, 1 A

Insert the connection cables laid by the customer through the threaded cable glands and secure. Connect the wires to the terminal strip according to the connection diagram. **Use the terminal number shown in the connection overview on the cover.** The number shown in location “x” on the symbol indicates which pump it refers to:

- 1 = pump 1
- 2 = pump 2
- 3 = pump 3

#### CAUTION

##### Do not apply external voltage!

An external voltage which is applied destroys the component.

An external alarm signal (horn, flashing light, etc.) can be connected. The output is switched in parallel to the collective fault signal (SSM).

- Alarm signal suitable for DC voltage.
- Connection load: 24 V<sub>DC</sub>, max. 4 VA
- **NOTICE! Observe the correct polarity when connecting!**
- Activate output in menu 5.67.

Insert the connection cables laid by the customer through the threaded cable glands and secure. Connect the wires to the terminal strip according to the connection diagram. **Use the terminal number shown in the connection overview on the cover.**



#### DANGER

##### Risk of fatal injury due to electrical current!

There is a risk of fatal injury when performing work on the open switchgear! The components carry current!

- Have work carried out by a qualified electrician.
- Avoid contact with earthed metal parts (pipes, frames etc.).



#### NOTICE

##### Mains-independent alarm

The alarm sounds as soon as the rechargeable battery is inserted. The alarm can only be switched off by removing the rechargeable battery again or by connecting the power supply.



By inserting a rechargeable battery, a mains-independent alarm signal can be issued in the case of a power failure. An audible, constant tone is emitted as an alarm. Observe the following points:

- Rechargeable battery type: E-Block, 9 V, Ni-MH
  - In order to ensure trouble-free operation, charge the rechargeable battery prior to insertion or charge it for 24 h in the switchgear.
  - The capacity of the rechargeable battery will fall if the ambient temperature drops. The alarm running time is reduced.
- ✓ Power supply connected.
  - ✓ Main switch in the "0/OFF" position!
- NOTICE! Switchgear without main switch: Disconnect power supply with mains isolator!**
1. Insert the rechargeable battery into the designated holder, see "Overview of components".  
**WARNING! Do not insert any batteries! There is a risk of explosion!**  
**CAUTION! Observe the correct polarity!**
  2. Plug in the connection cable.  
⇒ Alarm sounds!
  3. Turn the main switch to the "1/ON" position.  
**NOTICE! Switchgear without main switch: Establish power supply by means of mains isolator!**  
⇒ Alarm off!  
▶ Rechargeable battery installed.

## 6.5.18 Connection ModBus RTU

### CAUTION

#### Do not apply external voltage!

An external voltage which is applied destroys the component.

See Overview of components [▶ 14] for position numbers

9	ModBus: RS485 interface
11	ModBus: Jumper for termination/polarisation

The ModBus protocol is available for connection to a building management system. Insert the connection cable laid by the customer through the threaded cable glands and secure. Connect the wires to the terminal strip according to the connection diagram.

Observe the following points:

- Interface: RS485
- Field bus protocol settings: Menu 2.01 to 2.05.
- Terminate switchgear: Plug in jumper J2.
- If the ModBus requires a polarisation, plug in jumpers "J3" and "J4".

## 7 Operation



### DANGER

#### Risk of fatal injury due to electrical current!

Only operate the switchgear when closed. There is a risk of fatal injury from open switchgear! Electrical work on the internal components must be carried out by a qualified electrician.

### 7.1 How it works

In automatic mode, the pumps are switched on and off depending on the water level. Once the first activation point has been reached, pump 1 switches on. Once the second activation point has been reached, pump 2 switches on after the activation delay has elapsed. During operation, a visual indicator appears on the LCD display and the green LED lights up. Once the deactivation point has been reached, both pumps are switched off after the deactivation delay has elapsed. To optimise pump running times, pump cycling is carried out every time the pump is switched off.

An alarm signal is shown on the LCD display in case of a fault. If more than one pump is connected, automatic changeover to a fully-functional pump occurs. Additionally, the internal buzzer can emit an audible alarm signal. Furthermore, the outputs for the collective fault signal (SSM) and individual fault signal (ESM) are activated.

Upon reaching the dry run or high water level, the following occurs depending on the operating mode:

- Forced **shutdown** of all pumps.
- Forced **activation** of all pumps.

An alarm signal is also shown on the LCD display. Additionally, the internal buzzer can emit an audible alarm signal. Furthermore, the output for the collective fault signal (SSM) is activated.

#### 7.1.1 Priority when dry run and high water signals are present simultaneously

If the system malfunctions, it may happen that both signals are present at the same time. In this case, the priority is dependent upon the selected operating mode and thus the reaction of the switchgear:

- Operating mode “drain”
  1. Dry-running protection
  2. High water
- “Fill” operating mode
  1. Dry-running protection/low water (via “Extern OFF” input)
  2. High water
  3. Min. water level

#### 7.1.2 Pump cycling

To prevent irregular running times of the individual pumps, general pump cycling takes place. This means that all pumps work alternately.

#### 7.1.3 Forced switching of the pumps in case of dry run, min. water level or high water

Forced switching depends on the selected operating mode:

- High water level
 

**Operating mode “drain”:** A **forced switch-on\*** of all pumps always occurs, irrespective of the signal transmitter used.

**Operating mode “fill”:** A **forced switch-off** of all pumps always occurs, irrespective of the signal transmitter used.
- Dry-running level
 

**Operating mode “drain”:** A forced switch-off of all pumps always occurs, irrespective of the signal transmitter used.

**Operating mode “fill”:** Realise dry-running protection via the “Extern OFF” input.
- Min. water level
 

**Operating mode “fill”:** A **forced switch-on\*** of all pumps always occurs, irrespective of the signal transmitter used.

#### **NOTICE! Forced switch-on**

The following preconditions must be fulfilled so that a forced switch-on can be performed:

- Pumps are enabled (menu 3.01 to 3.04).
- The “Extern OFF” input is not active.

#### 7.1.4 Operation with a defective level sensor

If the level sensor does not transfer a measured value (e.g. due to wire break, defective sensor), all pumps are switched off. Furthermore, the fault signal LED lights up and the collective fault signal is activated.

#### **Emergency operation**

- Operating mode “drain”: High water level
 

If the high water level is performed by a separate float switch, the system can continue running in emergency operation. The activation and deactivation points are defined by the hysteresis of the float switch.
- Operating mode “fill”: Min. water level
 

If the min. water level is monitored by a separate float switch, the system can continue running in emergency operation. The activation and deactivation points are defined by the hysteresis of the float switch.

## 7.2 Operating modes



### NOTICE

#### Changing the operating mode

To change the operating mode, deactivate all pumps: in Menu 3.01, select the value „OFF“.



### NOTICE

#### Operating mode after power failure

Following a power failure, the switchgear will automatically start up in the last operating mode set.

### 7.2.1 “Drain” operating mode

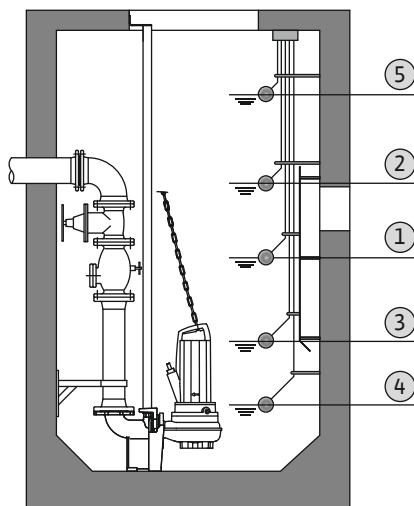

Fig. 24: Illustration of the switching points with a float switch or electrode in the “drain” operating mode using the example of two pumps

The following operating modes are possible:

- drain
- fill

The reservoir or pump chamber is drained. The pumps are activated when the level rises and switched off when the level falls. This control is mainly used for **water drainage**.

#### Level control for float switch or electrodes

1	Pump 1 On
2	Pump 2 On
3	Pump 1 and 2 Off
4	Dry-running level
5	High water level

Up to a maximum of five float switches or electrodes can be connected. This can be used to control two pumps:

- Pump 1 On
- Pump 2 On
- Pump 1 and 2 Off
- Dry-running level
- High water level

The float switch should be equipped with a NO contact: Once the switching point has been reached, the contact is closed.

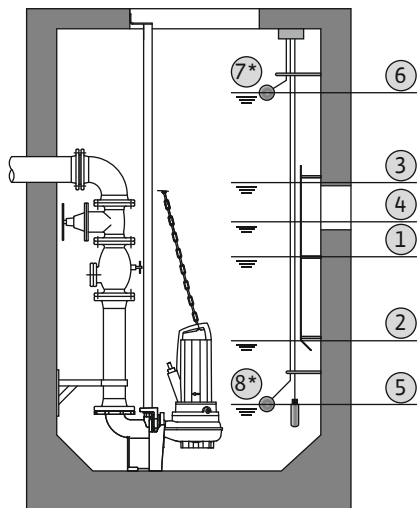

Fig. 25: Illustration of the switching points with a level sensor in the "drain" operating mode using the example of two pumps

### 7.2.2 "Fill" operating mode

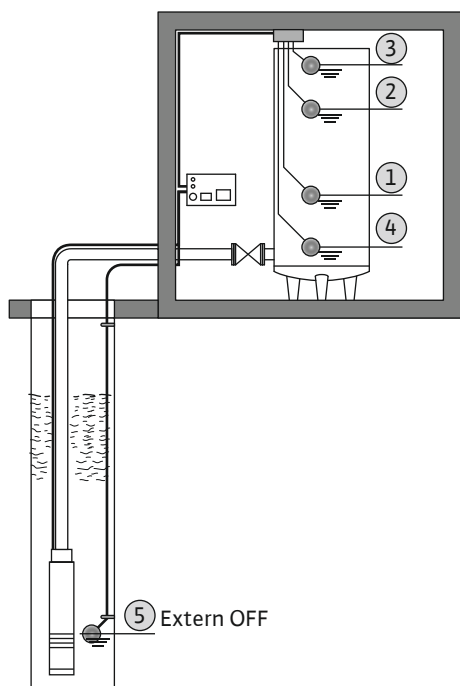

Fig. 26: Illustration of the switching points with a float switch or electrodes in the "fill" operating mode using the example of one pump

### Level measurement with level sensor or dynamic pressure bell

1	Pump 1 On
2	Pump 1 Off
3	Pump 2 On
4	Pump 2 Off
5	Dry-running level
6	High water level
7	High water level*
8	Dry-running level*

\* Also implemented via a separate float switch for increased operational reliability.

A level sensor or dynamic pressure bell can be connected. This can be used to control three pumps:

- Pump 1 On/Off
- Pump 2 On/Off
- Pump 3 On/Off
- Dry-running level
- High water level

The reservoir is filled up, for instance, to pump water into a rainwater storage tank. The pumps are activated when the level falls and switched off when the level rises. This control is mainly used for **water supply**.

### Level control for float switch or electrodes

1	Pump On
2	Pump OFF
3	High water level
4	Min. water level
5	Dry-running level in the well

Up to a maximum of six float switches or electrodes can be connected. This can be used to control two pumps:

- Pump 1 On
- Pump 2 On
- Pump 1 and 2 Off
- Min. water level in the tank to be filled
- High water level
- Dry-running level in the well (separate float switch at the "Extern OFF" input)

The float switch should be equipped with a NO contact: Once the switching point has been reached, the contact is closed.

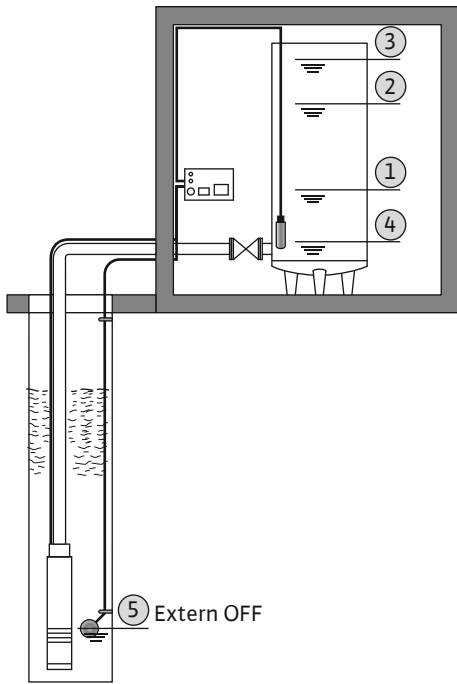

Fig. 27: Illustration of the switching points with a level sensor in the “fill” operating mode using the example of one pump

### 7.3 Menu control

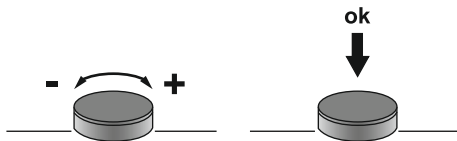

Fig. 28: Operating button function

### 7.4 Menu type: Main menu or Easy Actions menu

The menu is controlled via the operating button:

- **Turn:** Menu selection or settings values.
- **Press:** Change menu level, confirm error number or value.

There are two different menus.

- Main menu: Access to all settings for a complete configuration.
  - Easy Actions menu: Quick access to certain functions.
- Observe the following points when using the Easy Actions menu:

- The Easy Actions menu only offers access to the selected functions. It is not possible to perform a complete configuration with this.
- Perform an initial configuration to use the Easy Actions menu.
- The Easy Actions menu is enabled at the factory. Note, the Easy Actions menu can be **disabled in menu 7.06**.

### 7.5 Call up the menu

#### Call up the main menu

1. Press operating button for 3 seconds.
  - ▶ Menu item 1.00 appears.

#### Call up the Easy Actions menu

1. Turn operating button 180°.
  - ⇒ The “Resetting error messages” or “Manual operation pump 1” function appears
2. Turn operating button an additional 180°.
  - ▶ The other functions are shown. The main screen appears at the end.









### 7.6 Quick access to “Easy Actions”

The following functions can be called up using the Easy Actions menu:



Reset the current error message

**NOTICE! Menu point is only shown when an error is present!**

	<b>Manual operation pump 1</b> If the operating button is pressed, pump 1 runs. If the operating button is released, the pump switches off. The last set operating mode is active again.
	<b>Manual operation pump 2</b> If the operating button is pressed, pump 2 runs. If the operating button is released, the pump switches off. The last set operating mode is active again.
	<b>Manual operation pump 3</b> If the operating button is pressed, pump 3 runs. If the operating button is released, the pump switches off. The last set operating mode is active again.
	<b>Pump 1 switch off.</b> Corresponds to the "off" value in menu 3.02.
	<b>Pump 2 switch off.</b> Corresponds to the "off" value in menu 3.03.
	<b>Pump 3 switch off.</b> Corresponds to the "off" value in menu 3.04.
	<b>Automatic mode, pump 1</b> Corresponds to the "Auto" value in menu 3.02.
	<b>Automatic mode, pump 2</b> Corresponds to the "Auto" value in menu 3.03.
	<b>Automatic mode, pump 3</b> Corresponds to the "Auto" value in menu 3.04.

## 7.7 Factory settings

To reset the switchgear to the factory settings, contact customer service.

## 8 Commissioning

### 8.1 Operator responsibilities

- Provide installation and operating instructions at the switchgear or at a place specially reserved for it.
- Make the installation and operating instructions available in a language the personnel can understand.
- Make sure that the installation and operating instructions are read and understood by all personnel.
- The installation site of the switchgear is overflow-proof.
- The switchgear must be properly fused and earthed.
- The signal transmitter must be installed and set in accordance with the system documentation.
- Observe the minimum water submersion of the connected pumps.
- Safety devices (incl. emergency off) of the entire system are switched on and checked for trouble-free operation.
- The switchgear is suitable for use under the specified operating conditions.

### 8.2 Commissioning in explosive atmospheres

The switchgear may **not** be put into operation in potentially explosive atmospheres!



#### DANGER

#### Risk of explosion if the switchgear is installed in potentially explosive areas!

The switchgear does not have its own explosion protection class and must always be installed outside of potentially explosive areas! The connection must be made by a qualified electrician.

### 8.3 Connection of signal transmitters and pumps within potentially explosive atmospheres



#### DANGER

##### Risk of explosion due to incorrect connection!

If the connected pump and signal transmitter is installed in an explosive atmosphere (Ex zone), there is a risk of explosion due to incorrect connection:

- **Do not** connect electrode in an explosive atmosphere (Ex zone)!
- Connect the float switch using an Ex cut-off relay!
- Connect level sensor via a Zener barrier!
- Switch on ex-mode (menu 5.64)!
- Observe the section on explosive atmospheres in the appendix.
- Connection must be carried out by a qualified electrician.

### 8.4 Activating the device

#### 8.4.1 Possible error message during activation

Depending on the mains connection and the basic settings, the following error message may occur during activation. The error codes listed and their description apply to commissioning. A complete overview can be found in Chapter "Error codes [► 51]".

Code*	Fault	Software version	Cause	Remedies
E006	Rotating field error	all	<ul style="list-style-type: none"> <li>• Incorrect rotating field</li> <li>• Operation with single-phase AC current connection.</li> </ul>	<ul style="list-style-type: none"> <li>• Establish a clockwise rotating field at the mains connection.</li> <li>• Deactivate rotating field monitoring (menu 5.68)!</li> </ul>
E080.x	Pump fault	<b>Up to 2.01.x</b>	Operation with single-phase AC current connection.	Deactivate motor current monitoring (menu 5.69)!
E080.x	Pump fault	<b>From 2.02.x</b>	<ul style="list-style-type: none"> <li>• No pump connected.</li> <li>• Motor current monitoring not set.</li> </ul>	<ul style="list-style-type: none"> <li>• Connect pump or deactivate minimum current monitoring (menu 5.69)!</li> <li>• Set the motor current monitoring to the pump's rated current.</li> </ul>

#### Key:

\*\*"x" = represents the pump to which the fault shown applies!

#### 8.4.2 Activating the device



#### NOTICE

##### Observe the error code on the display

If the red fault LED lights up or flashes, observe the error code on the display! If the error has been confirmed, the previous error will be stored in menu 6.02.



#### NOTICE

##### Operating mode after power failure

Following a power failure, the switchgear will automatically start up in the last operating mode set.

- ✓ Switchgear is closed.
  - ✓ Installation has been performed correctly.
  - ✓ All signal transmitters and consumers are connected and installed in the operating space.
  - ✓ If float switches are used, set the switching points correctly.
  - ✓ Motor protection is preset according to the pump data.
1. Turn the main switch to the "ON" position.
  2. Switchgear starts.  
All LEDs light up for 2 s.

- The display illuminates and the start screen appears.
- The standby symbol appears in the display.
- ▶ The switchgear is ready for operation. Start the initial configuration or automatic mode.

#### Display with level sensor or dynamic pressure bell

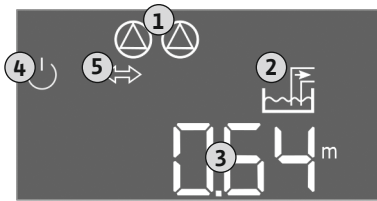

Fig. 29: Start screen: Level sensor/dynamic pressure bell

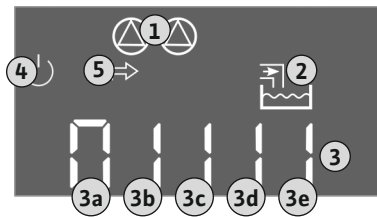

Fig. 30: Start screen: Float switch/electrode

1	Current pump status: – Number of registered pumps – Pump activated/deactivated – Pumps On/Off
2	Set operating mode (e.g. drain)
3	Current water level in m
4	Standby: Switchgear is ready for operation.
5	Field bus active

#### Display with float switch or electrodes

1	Current pump status: – Number of registered pumps – Pump activated/deactivated – Pumps On/Off
2	Set operating mode (e.g. fill)
3	Switching status of the float switch/electrode <ul style="list-style-type: none"> <li>• 0 = Float switch open/electrode not immersed</li> <li>• 1 = Float switch closed/electrode immersed</li> </ul>
4	Standby: Switchgear is ready for operation.
5	Field bus active

#### Designation of the float switch/electrode depending on the operating mode

No.	drain	fill
3a	High water level	High water level
3b	Pump 2 On	Pump 1 and 2 Off
3c	Pump 1 On	Pump 1 On
3d	Pump 1 and 2 Off	Pump 2 On
3e	Dry-running level	Min. level (low water)

## 8.5 Start initial configuration

Set the following parameters during initial configuration:

- Enable parameter input.
- Menu 5: Basic settings
- Menu 1: Activation/deactivation values
- Menu 2: Fieldbus connection (if available)
- Menu 3: Enable pumps.
- Set motor current monitoring.
- Check the direction of rotation of the connected pumps.

Observe the following points during the configuration:

- If there is no input or operation for 6 minutes:
  - the display illumination is switched off.
  - the display returns to the main screen.
  - parameter input is locked.
- Some settings can only be adjusted when there is no pump in operation.
- The menu is automatically adapted based on the settings. Example: The Menus 5.41 ... 5.43 are only visible when the “pump kick” function (Menu 5.40) is activated.
- The menu structure is valid for all EC switchgears (e.g. HVAC, Booster, Lift, Fire, etc.). This may lead to gaps in the menu structure.

### 8.5.1 Enable parameter input

As standard, the values are only displayed. To change the values, the parameter input in Menu 7.01 must be enabled:



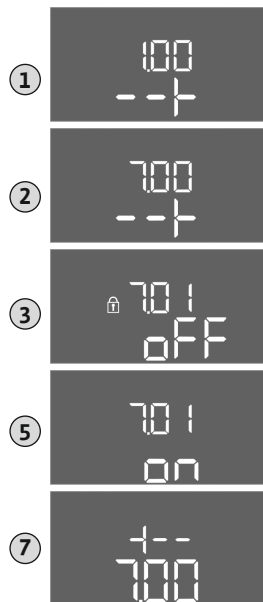

Fig. 31: Enable parameter input

1. Press the operating button for 3 s.  
⇒ Menu item 1.00 appears
2. Turn the operating button until menu 7 appears.
3. Press the operating button.  
⇒ Menu 7.01 appears.
4. Press the operating button.
5. Change the value to “on”: Turn the operating button.
6. Save value: Press the operating button.  
⇒ The menu is enabled and can be changed.
7. Turn the operating button until the end of menu 7 appears.
8. Press the operating button.  
⇒ Back to the main menu level.  
▶ Start initial configuration.

## 8.5.2 Menu 5: Basic settings



Fig. 32: Menu 5.01



Fig. 33: Menu 5.02

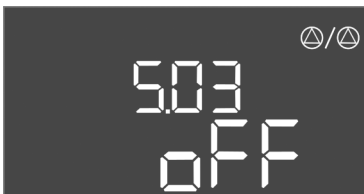

Fig. 34: Menu 5.03



Fig. 35: Menu 5.07

Menu no.	5.01
<b>Software version: All</b>	
Description	Operating mode
Value range	fill, drain
Factory setting	drain
Explanation	<ul style="list-style-type: none"> <li>Operating mode “drain”: The pumps are activated when the level rises and switched off when the level falls.</li> <li>Operating mode fill: The pumps are activated when the level falls and deactivated when the level rises</li> </ul>

Menu no.	5.02
<b>Software version: All</b>	
Description	Number of connected pumps
Value range	1 ... 3
Factory setting	2

Menu no.	5.03
<b>Software version: All</b>	
Description	Standby pump
Value range	on, off
Factory setting	off
Explanation	<p>One pump can be used as a standby pump. This pump is not activated during normal operation. The standby pump is only activated in the event of pump failure due to a fault. The standby pump is subject to standstill monitoring. The standby pump is therefore activated during pump cycling and pump kick.</p> <ul style="list-style-type: none"> <li>on = Standby pump activated</li> <li>off = Standby pump deactivated</li> </ul>

Menu no.	5.07
<b>Software version: Up to 2.01.x</b>	
Description	Signal transmitter for level measurement
Value range	Float, Level, Bell, Opt01
Factory setting	Level
Explanation	<p>Definition of the signal transmitters for level measurement:</p> <ul style="list-style-type: none"> <li>Float = float switch</li> <li>Level = level sensor</li> <li>Bell = dynamic pressure bell</li> <li>Opt01 = NW16 level monitor</li> </ul>

<b>Software version: from 2.02.x and hardware version: 2</b>	
Description	Signal transmitter for level measurement
Value range	Float, Level, Bell, Opt01
Factory setting	Level
Explanation	<p>Definition of the signal transmitters for level measurement:</p> <ul style="list-style-type: none"> <li>Float = float switch/electrode</li> <li>Level = level sensor</li> <li>Bell = dynamic pressure bell</li> <li>Opt01 = NW16 level monitor</li> </ul>



Fig. 36: Menu 5.09



Fig. 37: Menu 5.39

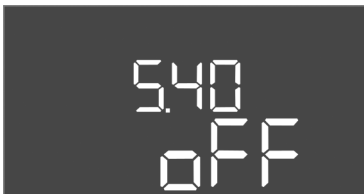

Fig. 38: Menu 5.40

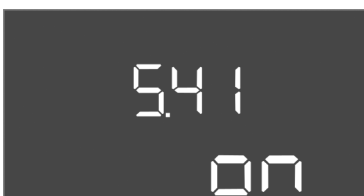

Fig. 39: Menu 5.41

Menu no.	5.09
<b>Software version: All</b>	
Description	Sensor measurement range
Value range	0.25 ... 12.5 m
Factory setting	1.0 m
Explanation	Maximum measured values of the sensor

Menu no.	5.39
<b>Software version: All</b>	
Description	Alarm signal with active "Extern OFF" input
Value range	off, on
Factory setting	off
Explanation	<p>The pumps can be switched off using a separate signal transmitter via the "Extern OFF" input. This function overrides all other switching points and all pumps are switched off.</p> <ul style="list-style-type: none"> <li>In the "fill" operating mode – select how the alarm signal occurs in the event of an active input:           <ul style="list-style-type: none"> <li>"off": the "Extern OFF" symbol appears on the LCD display</li> <li>"on": the "Extern OFF" symbol and the error code "E068" appear on the LCD display.</li> </ul> </li> <li>"Drain" operating mode – factory setting cannot be changed!</li> </ul>

Menu no.	5.40
<b>Software version: All</b>	
Description	Switch "pump kick" function On/Off
Value range	off, on
Factory setting	off
Explanation	<p>To prevent longer standstill times for the connected pumps, a periodical test run can be performed (pump kick function):</p> <ul style="list-style-type: none"> <li>off = pump kick deactivated</li> <li>on = pump kick activated</li> </ul> <p>If the pump kick function is activated, the following menu items can be set:</p> <ul style="list-style-type: none"> <li>Menu 5.41: Allows "pump kick" when status is Extern OFF</li> <li>Menu 5.42: Pump kick interval</li> <li>Menu 5.43: Pump kick duration</li> </ul>

Menu no.	5.41
<b>Software version: All</b>	
Description	Allows "pump kick" when status is Extern OFF
Value range	off, on
Factory setting	on
Explanation	<p>Select whether a pump kick may take place or not if the Extern OFF input is active:</p> <ul style="list-style-type: none"> <li>off = pump kick deactivated if Extern OFF is active.</li> <li>on = pump kick activated if Extern OFF is active.</li> </ul>



Fig. 40: Menu 5.42



Fig. 41: Menu 5.43

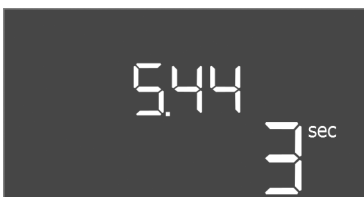

Fig. 42: Menu 5.44



Fig. 43: Menu 5.50



Fig. 44: Menu 5.51

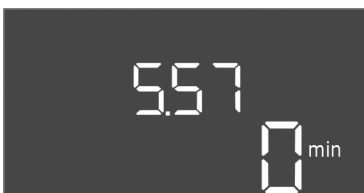

Fig. 45: Menu 5.57

Menu no.	5.42
<b>Software version: All</b>	
Description	"Pump kick interval"
Value range	1 ... 336 h
Factory setting	24 h
Explanation	Time after which a pump kick takes place.

Menu no.	5.43
<b>Software version: All</b>	
Description	"Pump kick duration"
Value range	0 ... 60 s
Factory setting	5 s
Explanation	How long a pump kick runs for a pump.

Menu no.	5.44
<b>Software version: All</b>	
Description	Activation delay after power failure
Value range	0 ... 180 s
Factory setting	3 s
Explanation	Time until the switchgear automatically restarts after a power outage.

Menu no.	5.50
<b>Software version: All</b>	
Description	Dry-running level (drain)/ min. water level (fill)
Value range	0 ... 12.5 m
Factory setting	0.15 m
Explanation	Enter fill level.  If the level is monitored with a separate float switch, <b>deactivate</b> the level sensor: <b>Enter the value "0.00 m"</b> .

Menu no.	5.51
<b>Software version: All</b>	
Description	High water level
Value range	0 ... 12.5 m
Factory setting	0.46 m
Explanation	Enter fill level.

Menu no.	5.57
<b>Software version: All</b>	
Description	Max. running time per pump
Value range	0 ... 60 min
Factory setting	0 min
Explanation	Maximum permissible running time of a pump. Once the time has been exceeded, the system switches to the next pump. After three change cycles, the collective fault signal (SSM) is activated.  The setting "0 min" switches the running time monitoring off.



Fig. 46: Menu 5.58



Fig. 47: Menu 5.59

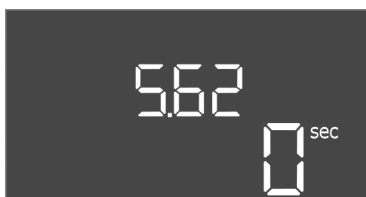

Fig. 48: Menu 5.62

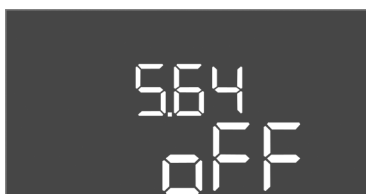

Fig. 49: Menu 5.64

Menu no.	5.58
<b>Software version: All</b>	
Description	Collective run signal (SBM) function
Value range	on, run
Factory setting	run
Explanation	A run signal for the switchgear or attached pump can sent via a separate output: <ul style="list-style-type: none"> <li>• “on”: Switchgear ready for operation</li> <li>• “run”: At least one pump is running.</li> </ul>

Menu no.	5.59
<b>Software version: All</b>	
Description	Collective fault signal (SSM) function
Value range	fall, raise
Factory setting	raise
Explanation	In case of an error, a general fault message can be sent via a separate output: <ul style="list-style-type: none"> <li>• “fall”: The relay drops out. Optionally, this function can be used for controlling the mains voltage supply.</li> <li>• “raise”: The relay picks up.</li> </ul>

Menu no.	5.62
<b>Software version: All</b>	
Description	Dry-running protection delay
Value range	0 ... 180 s
Factory setting	0 s
Explanation	Time until the pump are deactivated after reaching the dry run level.

Menu no.	5.64
<b>Software version: All</b>	
Description	Ex-mode On/Off (only available in the “drain” operating mode!)
Value range	on, off
Factory setting	off
Explanation	The following functions are adjusted when the Ex-mode is activated (on): <ul style="list-style-type: none"> <li>• Follow-up times All follow-up times are ignored and the pumps switched off immediately!</li> <li>• Dry-running level (by level sensor or dynamic pressure bell) The following actions are only possible once the “All pumps off” fill level has been exceeded: <ul style="list-style-type: none"> <li>– Reactivation of the pumps</li> <li>– Resetting the error message</li> </ul> </li> <li>• Alarm dry-running protection (via float switch) Alarm manual reset (anti-reactivation lock)!</li> <li>• Alarm thermal motor monitoring Alarm manual reset (anti-reactivation lock)!</li> </ul> <p>Observe the additional requirements in the chapter on explosive atmospheres in the appendix!</p>



Fig. 50: Menu 5.65



Fig. 51: Menu 5.66

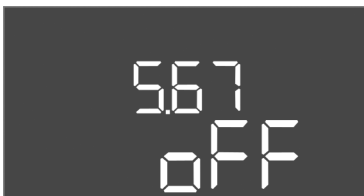

Fig. 52: Menu 5.67

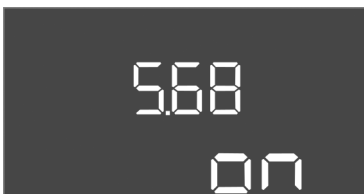

Fig. 53: Menu 5.68

Menu no.	5.65
<b>Software version: All</b>	
Description	Automatic resetting of error "Dry run"
Value range	on, off
Factory setting	on
Explanation	If the fill level is over the dry run level again, the error message "dry run" is automatically reset. <ul style="list-style-type: none"> <li>• on = function activated</li> <li>• off = function deactivated</li> </ul>

Menu no.	5.66
<b>Software version: All</b>	
Description	Integrated buzzer On/Off
Value range	off, error
Factory setting	off
Explanation	Switching the buzzer on or off: <ul style="list-style-type: none"> <li>• off = buzzer off</li> <li>• error = buzzer on</li> </ul> <p><b>NOTICE! Alarm in the event of interrupted power supply: To switch off the internal buzzer if there is a built-in re-chargeable battery, remove the battery!</b></p>

Menu no.	5.67
<b>Software version: All</b>	
Description	Output (24 V=, max. 4 VA) On/Off for an external signalling unit
Value range	off, error
Factory setting	off
Explanation	Separate output to switch an external alarm signal on or off: <ul style="list-style-type: none"> <li>• off = output deactivated</li> <li>• error = output activated</li> </ul>

Menu no.	5.68
<b>Software version: All</b>	
Description	Mains connection rotating field monitoring On/Off
Value range	on, off
Factory setting	on
Explanation	Integrated rotating field monitoring for the mains connection. If no clockwise rotating field is present, an error message occurs. <ul style="list-style-type: none"> <li>• off = rotating field monitoring deactivated</li> <li>• on = rotating field monitoring activated</li> </ul> <p><b>NOTICE! When operating the switchgear via a single-phase current connection, switch off this function!</b></p>



Fig. 54: Menu 5.69

Menu no.	5.69
<b>Software version: Up to 2.01.x</b>	
Description	Motor current monitoring On/Off
Value range	on, off
Factory setting	on
Explanation	<p>The integrated motor current monitoring outputs an error if the set rated current is exceeded.</p> <ul style="list-style-type: none"> <li>• off = motor current monitoring deactivated</li> <li>• on = motor current monitoring activated</li> </ul> <p><b>NOTICE! If the switchgear is connected to a single-phase current, switch off this function!</b></p>

<b>Software version: From 2.02.x</b>	
Description	Motor current monitoring On/Off
Value range	on, off
Factory setting	on
Explanation	<p>The integrated motor current monitoring keeps tabs on the minimum and maximum rated current of the pump:</p> <ul style="list-style-type: none"> <li>• Monitoring the minimum rated current If no current is measured when the pump is switched on, the integrated motor current monitoring outputs an error.</li> <li>• Monitoring the maximum rated current The integrated motor current monitoring outputs an error if the set rated current is exceeded.</li> </ul> <p>This function can be set as follows:</p> <ul style="list-style-type: none"> <li>• on = activate monitoring the minimum rated current.</li> <li>• off = deactivate monitoring the minimum rated current.</li> <li>• Monitoring the maximum rated current <b>cannot</b> be deactivated.</li> </ul>



Fig. 55: Menu 5.70

Menu no.	5.70
<b>Software version: All</b>	
Description	Max. switching frequency per hour, per pump
Value range	0 ... 60
Factory setting	0
Explanation	<p>If the max. number of starts has been exceeded, the collective fault signal (SSM) is activated. To deactivate the function, set the <b>value "0"</b>.</p>

### 8.5.3 Menu 1: Values for switching on and off



Fig. 56: Menu 1.09



Fig. 57: Menu 1.10



Fig. 58: Menu 1.11



Fig. 59: Menu 1.12



Fig. 60: Menu 1.13

Menu no.	1.09
<b>Software version: All</b>	
Description	Base-load pump switch-off delay
Value range	0 ... 60 s
Factory setting	0 s
Explanation	Time until the base-load pump is switched off after the fill levels are reached.

Menu no.	1.10
<b>Software version: All</b>	
Description	Peak-load pump activation delay
Value range	0 ... 30 s
Factory setting	3 s
Explanation	Time until the peak-load pump is switched on after the fill levels are reached.

Menu no.	1.11
<b>Software version: All</b>	
Description	Peak-load pump switch-off delay
Value range	0 ... 30 s
Factory setting	1 s
Explanation	Time until the peak-load pump is switched off after the fill levels are reached.

Menu no.	1.12
<b>Software version: All</b>	
Description	Base-load pump On level
Value range	0.06 ... 12.5 m ( <b>NOTICE! The actual value range is dependent on the setting in menu 5.09.</b> )
Factory setting	0.40 m
Explanation	<p>“Drain” operating mode: Value must be 0.03 m <b>higher</b> than the “Base-load pump Off level” (menu 1.13).</p> <p>“Fill” operating mode: Value must be 0.03 m <b>lower</b> than the “Base-load pump Off level” (menu 1.13).</p> <p><b>NOTICE! The menu item is only visible if the value “Level” or “Bell” have been set in menu 5.07.</b></p>

Menu no.	1.13
<b>Software version: All</b>	
Description	Base-load pump Off level
Value range	0.06 ... 12.5 m ( <b>NOTICE! The actual value range is dependent on the setting in menu 5.09.</b> )
Factory setting	0.23 m
Explanation	<p>“Drain” operating mode: Value must be 0.03 m <b>lower</b> than the “Base-load pump On” level (menu 1.12).</p> <p>“Fill” operating mode: Value must be 0.03 m <b>higher</b> than the “Base-load pump On level” (menu 1.12).</p> <p><b>NOTICE! The menu item is only visible if the value “Level” or “Bell” have been set in menu 5.07.</b></p>





Fig. 61: Menu 1.14



Fig. 62: Menu 1.15



Fig. 63: Menu 1.16

Menu no.	1.14
<b>Software version: All</b>	
Description	Level peak-load pump 1 on
Value range	0.06 ... 12.5 m ( <b>NOTICE! The actual value range is dependent on the setting in menu 5.09.</b> )
Factory setting	0.42 m
Explanation	<p>“Drain” operating mode: The value must be 0.03 m <b>higher</b> than the “Peak-load pump 1 On” level (menu 1.15). The switch-on level must be <b>greater than/equal to</b> the switch-on level of the base-load pump (menu 1.12).</p> <p>“Fill” operating mode: The value must be 0.03 m <b>lower</b> than the “Peak-load pump 1 Off” level (menu 1.15). The switch-on level must be <b>lower than/equal to</b> the switch-on level of the base-load pump (menu 1.12).</p> <p><b>NOTICE! The menu item is only visible if the value “Level” or “Bell” have been set in menu 5.07.</b></p>

Menu no.	1.15
<b>Software version: All</b>	
Description	Peak-load pump 1 Off level
Value range	0.06 ... 12.5 m ( <b>NOTICE! The actual value range is dependent on the setting in menu 5.09.</b> )
Factory setting	0.25 m
Explanation	<p>“Drain” operating mode: The value must be 0.03 m <b>lower</b> than the “Peak-load pump 1 On” level (menu 1.14). The switch-off level must be <b>greater than/equal to</b> the switch-on level of the base-load pump (menu 1.13).</p> <p>“Fill” operating mode: The value must be 0.03 m <b>higher</b> than the “Peak-load pump 1 On” level (menu 1.14). The switch-off level must be <b>lower than/equal to</b> the switch-off level of the base-load pump (menu 1.13).</p> <p><b>NOTICE! The menu item is only visible if the value “Level” or “Bell” have been set in menu 5.07.</b></p>

Menu no.	1.16
<b>Software version: All</b>	
Description	Peak-load pump 2 On level
Value range	0.06 ... 12.5 m ( <b>NOTICE! The actual value range is dependent on the setting in menu 5.09.</b> )
Factory setting	0.42 m
Explanation	<p>“Drain” operating mode: The value must be 0.03 m <b>higher</b> than the “Peak-load pump 2 Off” level (menu 1.17). The switch-on level must be <b>greater than/equal to</b> the switch-on level of the peak-load pump (menu 1.14).</p> <p>“Fill” operating mode: The value must be 0.03 m <b>lower</b> than the “Peak-load pump 2 Off” level (menu 1.17). The switch-on level must be <b>lower than/equal to</b> the switch-on level of the peak-load pump (menu 1.14).</p> <p><b>NOTICE! The menu item is only visible if the value “Level” or “Bell” have been set in menu 5.07.</b></p>



Fig. 64: Menu 1.17

Menu no.	1.17
<b>Software version: All</b>	
Description	Peak-load pump 2 Off level
Value range	0.06 ... 12.5 m ( <b>NOTICE! The actual value range is dependent on the setting in menu 5.09.</b> )
Factory setting	0.25 m
Explanation	<p>“Drain” operating mode: The value must be 0.03 m <b>lower</b> than the “Peak-load pump 2 On” level (menu 1.16). The switch-off level must be <b>greater than/equal to</b> the switch-off level of the peak-load pump (menu 1.15).</p> <p>“Fill” operating mode: The value must be 0.03 m <b>higher</b> than the “Peak-load pump 2 On” level (menu 1.16). The switch-off level must be <b>lower than/equal to</b> the switch-off level of the peak-load pump (menu 1.15).</p> <p><b>NOTICE! The menu item is only visible if the value “Level” or “Bell” have been set in menu 5.07.</b></p>

#### 8.5.4 Menu 2: ModBus RTU connection

The switchgear is equipped with an RS485 interface for connection via ModBus RTU. Different parameters can be read and also changed to some extent via the interface. In this case, the switchgear works as a Modbus slave. An overview of individual parameters and a description of the data types used are shown in the appendix.



Fig. 65: Menu 2.01



Fig. 66: Menu 2.02

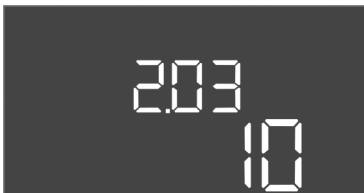

Fig. 67: Menu 2.03

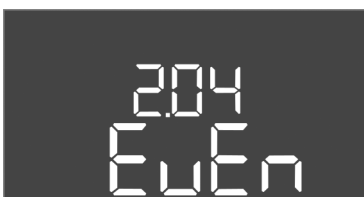

Fig. 68: Menu 2.04

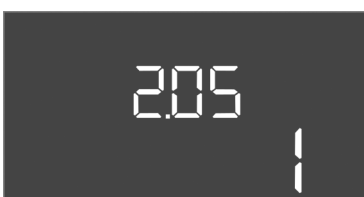

Fig. 69: Menu 2.05

### 8.5.5 Menu 3: Enable pumps



To use the ModBus interface, the settings must be changed in the following menus:

Menu no.	2.01
Description	ModBus RTU interface On/Off
Value range	on, off
Factory setting	off

Menu no.	2.02
Description	Baud rate
Value range	9600; 19200; 38400; 76800
Factory setting	19200

Menu no.	2.03
Description	Slave address
Value range	1 ... 254
Factory setting	10

Menu no.	2.04
Description	Parity
Value range	none, even, odd
Factory setting	even

Menu no.	2.05
Description	Number of stop bits
Value range	1; 2
Factory setting	1

To operate the system, the operating mode must be set for each pump and the pumps enabled:

- Every pump is set to the “auto” operating mode as the factory setting.
- Automatic mode starts after the pumps have been enabled in menu 3.01.

**NOTICE! Required settings for the initial configuration.**

During the initial configuration, a direction of rotation check must be performed on the pumps and the motor current monitoring set exactly. Use the following settings to perform the initial configuration:

- Switch off the pumps: Set menu 3.02 to 3.04 to “off”.



Fig. 70: Menu 3.02



Fig. 71: Menu 3.01

- Enable pumps: Set menu 3.01 to “on”.

Menu no.	3.02 ... 3.04
<b>Software version: All</b>	
Description	Pump 1 ... Pump 3 operating mode
Value range	off, Hand, Auto
Factory setting	Auto
Explanation	<ul style="list-style-type: none"> <li>• off = pump switched off</li> <li>• Hand = manual operation pump, as long as the button is pressed.</li> <li>• Auto = level-control-dependent automatic operation of the pump</li> </ul> <p><b>NOTICE! Change the value to “off” for the initial configuration!</b></p>

Menu no.	3.01
<b>Software version: All</b>	
Description	Enable pumps
Value range	on, off
Factory setting	off
Explanation	<ul style="list-style-type: none"> <li>• off = pumps are locked and cannot be started.</li> </ul> <p><b>NOTICE! Manual operation or forced switch-on are also not possible!</b></p> <ul style="list-style-type: none"> <li>• on = pumps are switched on/off, depending on the operating mode set</li> </ul>

### 8.5.6 Adjust motor current monitoring



#### DANGER

##### Risk of fatal injury due to electrical current!

There is a risk of fatal injury when performing work on the open switchgear! The components carry current!

- Have work carried out by a qualified electrician.
- Avoid contact with earthed metal parts (pipes, frames etc.).

#### Indicate the actual value of the motor current monitoring

1. Press the operating button for 3 s.  
⇒ Menu 1.00 appears.
2. Turn the operating button until menu 4.00 appears.
3. Press the operating button.  
⇒ Menu 4.01 appears.
4. Turn the operating button until menu 4.25 to 4.27 appears.  
⇒ Menu 4.25: Shows the set motor current for pump 1.  
⇒ Menu 4.26: Shows the set motor current for pump 2.  
⇒ Menu 4.27: Shows the set motor current for pump 3.  
▶ Actual value of the motor current monitoring checked.  
Compare the set value with the specification on the rating plate. If the set value differs from the specification on the rating plate, adjust the value.

#### Adjust the motor current monitoring value

- ✓ Motor current monitoring settings checked.
1. Turn the operating button until menu 4.25 to 4.27 appears.  
⇒ Menu 4.25: Shows the set motor current for pump 1.  
⇒ Menu 4.26: Shows the set motor current for pump 2.  
⇒ Menu 4.27: Shows the set motor current for pump 3.

2. Open the switchgear.  
**DANGER! Risk of fatal injury due to electric current! There is a risk of fatal injury when performing work on the open switchgear! This work must be carried out by a qualified electrician!**
3. Correct the motor current on the potentiometer with a screwdriver (see Overview of components [▶ 14]). Read changes directly off the display.
4. Once all of the motor currents have been corrected, close the switchgear.
  - ▶ Motor current monitoring set. Perform direction of rotation check.

### 8.5.7 Check the direction of rotation of the connected pumps



#### NOTICE

##### Rotating field, power supply and pump connection

The rotating field is routed from the mains connection directly to the pump connection. Check the required rotating field of the pumps to be connected (clockwise or counter-clockwise)! Observe the installation and operating instructions of the pumps.

Perform a test run to check the direction of rotation of the pumps. **CAUTION! Damage to property! Perform the test run under the prescribed operating conditions.**

- ✓ The switchgear is closed.
  - ✓ Configuration of menu 5 and menu 1 complete.
  - ✓ All pumps are switched off in menu 3.02 to 3.04: Value is "off".
  - ✓ The pumps are enabled in menu 3.01: Value is "on".
1. Start Easy Actions menu: Turn the operating button 180°.
  2. Select the pump's manual operation mode: turn the operating button until the menu item is displayed:
    - Pump 1: P1 Hand
    - Pump 2: P2 Hand
    - Pump 3: P3 Hand
  3. Start test run: Press the operating button. The pump runs until the operating button is released.
  4. Check direction of rotation.
    - ⇒ **Incorrect direction of rotation:** Exchange the two phases on the pump connection.
    - ▶ Direction of rotation checked and corrected as necessary. The initial configuration is complete.

### 8.6 Start automatic mode

#### Automatic mode after initial configuration

- ✓ The switchgear is closed.
  - ✓ Configuration complete.
  - ✓ Direction of rotation correct.
  - ✓ Motor current monitoring set correctly.
1. Start Easy Actions menu: Turn the operating button 180°.
  2. Select the pump for automatic mode: Turn the operating button until the menu item is displayed:
    - Pump 1: P1 Auto
    - Pump 2: P2 Auto
    - Pump 3: P3 Auto
  3. Press the operating button.
    - ⇒ Automatic mode is set for the selected pump. Alternatively, setting can be performed in Menu 3.02 to 3.04.
    - ▶ Automatic mode switched on.

#### Automatic mode after shutdown

- ✓ The switchgear is closed.
- ✓ Checked configuration.

- ✓ Parameter input enabled: Menu 7.01 shows on.
- 1. Press the operating button for 3 s.  
⇒ Menu 1.00 appears.
- 2. Turn the operating button until menu 3.00 appears
- 3. Press the operating button.  
⇒ Menu 3.01 appears.
- 4. Press the operating button.
- 5. Change value to “on”.
- 6. Press the operating button.  
⇒ Value saved, pump enabled.  
▶ Automatic mode switched on.

## 8.7 During operation

Make sure the following points are observed during operation:





- Keep the switchgear closed and secure it against unauthorised opening.
- Switchgear attached in an overflow-proof manner (protection class IP54).
- Not exposed to direct sunlight.
- Ambient temperature: -30 ... +50 °C.

The following items of information are shown on the main screen:

- Pump status:
  - Number of registered pumps
  - Pump activated/deactivated
  - Pump On/Off
- Operation with standby pump
- Operating mode: fill or drain
- Current water level or switching state of the float switch
- Active field bus operation

Furthermore, the following information is available via menu 4:

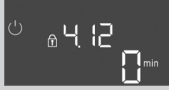
1. Press the operating button for 3 s.  
⇒ Menu 1.00 appears.
2. Turn the operating button until menu 4 appears.
3. Press the operating button.  
▶ Menu 4.xx appears.

	Current water level in m
	Current switching state of the float switch
	Switchgear running time The time* is stated depending on the unit, in minutes (min), hours (h) or days (d).
	Running time: Pump 1 The time is stated in minutes (min), hours (h) or days (d) depending on the unit. The display varies depending on the timespan: <ul style="list-style-type: none"> <li>• 1 hour: Display in 0 ... 59, unit: min</li> <li>• 2 hours to 24 hours: Display in hours and minutes separated by a decimal point, e.g. 10.59, unit: h</li> <li>• 2 days to 999 days: Display in days and hours separated by a decimal point, e.g. 123.7, unit: d</li> <li>• From 1000 days: Display in days, unit: d</li> </ul>
	Running time: Pump 2 The time is stated in minutes (min), hours (h) or days (d) depending on the unit.

	Running time: Pump 3 The time is stated in minutes (min), hours (h) or days (d) depending on the unit.
	Switchgear switching cycles
	Switching cycles: Pump 1
	Switching cycles: Pump 2
	Switching cycles: Pump 3
	Serial number Display switches between the 1st and 2nd four digits.
	Switchgear type
	Software version
	Set value for the motor current monitoring: Pump 1 Max. Rated current in A
	Set value for the motor current monitoring: Pump 2 Max. Rated current in A
	Set value for the motor current monitoring: Pump 3 Max. Rated current in A
	Current rated current of pump 1 in A display changes between L1, L2 and L3 press and hold the operating button. The pump starts after 2 s of pumping operation until the operating button is released.
	Current rated current in A for pump 2 display changes between L1, L2 and L3 press and hold the operating button. The pump starts after 2 s of pumping operation until the operating button is released.
	Current rated current in A for pump 3 display changes between L1, L2 and L3 press and hold the operating button. The pump starts after 2 s of pumping operation until the operating button is released.

## 9 Shut-down

### 9.1 Personnel qualifications

- Electrical work: qualified electrician  
Person with appropriate technical training, knowledge and experience who can identify and prevent electrical hazards.
- Installation/dismantling work: qualified electrician  
Knowledge regarding tools and fixation material for various structures

### 9.2 Operator responsibilities

- Observe locally applicable accident prevention and safety regulations of trade associations.
- Make sure that the personnel has had the corresponding training for the specified work.
- Train the personnel on how the system operates.
- When working in enclosed spaces, a second person must be present for safety reasons.
- Ensure enclosed spaces have sufficient ventilation.

### 9.3 Shut-down

- Take immediate countermeasures if there is a build-up of toxic or suffocating gases!

To decommission the pumps, switch off the pumps and switchgear at the main switch. The settings are stored in non-volatile memory in the switchgear and are not deleted. This ensures that the switchgear is always ready for operation. Adhere to the following points during the standstill period:

- Ambient temperature:  $-30 \dots +50 \text{ }^{\circ}\text{C}$
  - Max. humidity: 90 %, non-condensing
  - ✓ Parameter input enabled: Menu 7.01 shows on.
1. Press the operating button for 3 s.  
⇒ Menu 1.00 appears.
  2. Turn the operating button until menu 3.00 appears
  3. Press the operating button.  
⇒ Menu 3.01 appears.
  4. Press the operating button.
  5. Change value to "off".
  6. Press the operating button.  
⇒ Value saved, pump switched off.
  7. Turn main switch to the "OFF" position.
  8. Secure the main switch against being activated by unauthorised persons (e.g. lock main switch)
    - ▶ Switchgear switched off.

### 9.4 Removal



#### **DANGER**

##### **Risk of fatal injury due to electrical current!**

Improper conduct when carrying out electrical work can lead to death due to electric shock!

- Electrical work must be carried out by a qualified electrician!
- Observe local regulations!

- ✓ Decommissioning performed.
  - ✓ Mains connection is switched so that it is voltage-free and safeguarded against being activated by unauthorised persons.
  - ✓ The power connection for fault and run signals is switched so that it is voltage-free and safeguarded against being activated by unauthorised persons.
1. Open the switchgear.
  2. Disconnect all connection cables and pull them out through the threaded cable connection.
  3. Close off the ends of the connection cables watertight.
  4. Seal threaded cable connections watertight.
  5. Support the switchgear (e.g. get a second person to help).
  6. Loosen the switchgear fastening screws and remove the switchgear from the structure.
    - ▶ Switchgear removed. Observe the following for storage!

## 10 Maintenance and repair



#### **DANGER**

##### **Risk of fatal injury due to electrical current!**

Improper conduct when carrying out electrical work can lead to death due to electric shock!

- Electrical work must be carried out by a qualified electrician!
- Observe local regulations!





## NOTICE

### Unauthorised work or structural changes are prohibited!

Only maintenance and repair work described in this manual may be carried out. All other works and any alterations to the construction may only be carried out by the manufacturer.

## 10.1 Maintenance intervals

## 10.2 Maintenance tasks

## 10.3 Maintenance interval display



Fig. 72: Maintenance interval display

### 10.3.1 Maintenance interval – Activate the interval indicator



Fig. 73: Activating the maintenance interval

### Regular

- Clean switchgear.

### Annually

- Check electro-mechanical components for wear.

### After 10 years

- General overhaul

### Cleaning switchgear

- ✓ Switch off switchgear.

1. Clean switchgear with a damp cotton cloth.

**Do not use any aggressive or scouring cleaners or fluids!**

### Check electrical-mechanical components for wear

Have electrical-mechanical components checked for wear by an electrician. If wear is ascertained, have the affected components replaced by an electrician or by the Wilo Customer Service.

### General overhaul

During a general overhaul, all of the components, wiring and the housing are checked for wear. Defective or worn components are replaced.

The switchgear has an integrated maintenance interval indicator. Once the set interval has expired, “SER” on the main screen blinks. The next interval starts automatically by resetting the current interval. The function is disabled at the factory.

- ✓ Parameter input enabled: Menu 7.01 shows on.
1. Press the operating button for 3 s.  
⇒ Menu 1.00 appears.
  2. Turn the operating button until menu 7 appears
  3. Press operating button.  
⇒ Menu 7.01 appears.
  4. Turn the operating button until menu 7.07 appears.
  5. Press the operating button.
  6. Set desired interval:
    - 0 = interval display off.
    - 0.25 = quarterly
    - 0.5 = six-monthly
    - 1 = annually
    - 2 = every two years
  7. Press the operating button.  
⇒ Value is saved.  
▶ Interval display is activated.

### 10.3.2 Maintenance interval – reset the maintenance interval



Fig. 74: Reset the maintenance interval

- ✓ The “SER” message flashes on the display.
  - ✓ Parameter input enabled: Menu 7.01 shows on.
1. Press the operating button for 3 s.  
⇒ Menu 1.00 appears.
  2. Turn the operating button until menu 7 appears
  3. Press operating button.  
⇒ Menu 7.01 appears.
  4. Turn the operating button until menu 7.08 appears.
  5. Press the operating button.
  6. Change value to “on”.
  7. Press the operating button.  
⇒ Display reset.
- ▶ Current maintenance interval reset, new maintenance interval started.

## 11 Faults, causes and remedies



### DANGER

#### Risk of fatal injury due to electrical current!

Improper conduct when carrying out electrical work can lead to death due to electric shock!

- Electrical work must be carried out by a qualified electrician!
- Observe local regulations!

### 11.1 Operator responsibilities

- Observe locally applicable accident prevention and safety regulations of trade associations.
- Make sure that the personnel has had the corresponding training for the specified work.
- Train the personnel on how the system operates.
- When working in enclosed spaces, a second person must be present for safety reasons.
- Ensure enclosed spaces have sufficient ventilation.
- Take immediate countermeasures if there is a build-up of toxic or suffocating gases!

### 11.2 Fault indication

Possible faults are shown by the fault LEDs and alphanumeric codes on the display. Have system checked according to the displayed fault and have defective components replaced. Faults are displayed in various ways:

- Fault in the control/on the switchgear:
  - The red fault signal LED **lights up**.
  - Display of the error code alternates with the main screen. The error code is stored in the fault memory.
  - The collective fault signal is activated.
  - If the internal buzzer is activated, there is an audible alarm signal.
- Pump fault  
**Status icon** of the respective pump **flashes** on the display.

### 11.3 Fault acknowledgement

Switch off the alarm display by pressing the operating button. Acknowledge the fault via the main menu or Easy Actions menu.

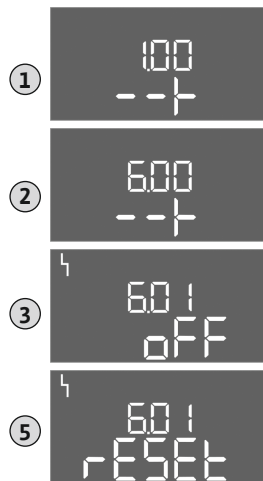

Fig. 75: Acknowledge fault

#### Main menu

- ✓ All faults rectified.
- 1. Press the operating button for 3 s.  
⇒ Menu 1.00 appears.
- 2. Turn the operating button until menu 6 appears.
- 3. Press the operating button.  
⇒ Menu 6.01 appears.
- 4. Press the operating button.
- 5. Change the value to “reset”: Turn the operating button.
- 6. Press the operating button.  
▶ The fault indication is reset.

#### Easy Actions menu

- ✓ All faults rectified.
- 1. Starting the Easy Actions menu: Turn the operating button 180°.
- 2. Select menu item “Err reset”.
- 3. Press the operating button.  
▶ The fault indication is reset.

#### Fault acknowledgement failed

If there are further faults, the faults are displayed as follows:

- The fault LED lights up.
- The error code of the last fault is shown in the display.  
All other faults can be called up from the fault memory.

If all faults have been rectified, acknowledge the faults again.

### 11.4 Fault memory

The switchgear stores the last ten faults in the fault memory. The fault memory works according to the first in/first out principle. The faults are displayed in descending order in the menu items 6.02 to 6.11:

- 6.02: the last/latest fault
- 6.11: the oldest fault

### 11.5 Error codes

The functions may operate differently depending on the software version. That is why a software version is included with every error code.

The details regarding the software version used can be read on the rating plate or displayed via menu 4.24.

Code*	Fault	Software version	Cause	Remedies
E006	Rotating field error	all	<ul style="list-style-type: none"> <li>• Incorrect rotating field</li> <li>• Operation via single-phase current connection</li> </ul>	<ul style="list-style-type: none"> <li>• Establish a clockwise rotating field at the mains connection.</li> <li>• Deactivate rotating field monitoring (menu 5.68)!</li> </ul>
E014.x	Leakage detection	all	The moisture probe of the connected pump was tripped.	See the installation and operating instructions of the connected pump
E040	Fault, level sensor	all	No connection to the sensor	Check the connection cable and sensor. Replace the defective component.
E062	Dry-running protection active** / min. water level active**	all	<ul style="list-style-type: none"> <li>• Operating mode “<b>drain</b>”: Dry-running level reached</li> <li>• Operating mode “<b>fill</b>”: Min. water level, below minimum value</li> </ul>	<ul style="list-style-type: none"> <li>• Check inlet and system parameters.</li> <li>• Check that the float switch is working correctly, replace the defective component.</li> </ul>
E066	High water alarm active	all	High water level reached	<ul style="list-style-type: none"> <li>• Check inlet and system parameters.</li> <li>• Check that the float switch is working correctly, replace the defective component.</li> </ul>

Code*	Fault	Software version	Cause	Remedies
E068	Extern OFF active	all	The "Extern OFF" contact is active; the active contact is defined as alarm	Check the connection of the "Extern OFF" contact as per the current connection diagram.
E080.x	Pump fault**	Up to 2.01.x	<ul style="list-style-type: none"> <li>• Operation via single-phase current connection</li> <li>• No feedback from the corresponding contactor.</li> <li>• Bimetallic strip has been tripped.</li> <li>• Motor current monitoring has been tripped.</li> </ul>	<ul style="list-style-type: none"> <li>• Deactivate motor current monitoring (menu 5.69)!</li> <li>• Check functionality of pump.</li> <li>• Check that the motor has sufficient cooling.</li> <li>• Check the set rated current and correct if necessary.</li> <li>• Contact customer service.</li> </ul>
E080.x	Pump fault**	From 2.02.x	<ul style="list-style-type: none"> <li>• No pump connected.</li> <li>• Motor current monitoring not set (potentiometer is at 0)</li> <li>• No feedback from the corresponding contactor.</li> <li>• Bimetallic strip has been tripped.</li> <li>• Motor current monitoring has been tripped.</li> </ul>	<ul style="list-style-type: none"> <li>• Connect pump or deactivate minimum current monitoring (menu 5.69)!</li> <li>• Set the motor current monitoring to the pump's rated current.</li> <li>• Check functionality of pump.</li> <li>• Check that the motor has sufficient cooling.</li> <li>• Check the set rated current and correct if necessary.</li> <li>• Contact customer service.</li> </ul>
E085.x	Pump running time monitoring***	Up to 1.xx.x	Maximum running time of the pump exceeded	<ul style="list-style-type: none"> <li>• Check the operating parameters (inlet, switching points).</li> <li>• Check that other pumps function.</li> </ul>
E090	Plausibility error	all	Float switches are in incorrect sequence	Check the installation and connections of the float switch.
E140.x	Pump starts exceeded***	all	The max. number of pump starts has been exceeded	<ul style="list-style-type: none"> <li>• Check the operating parameters (inlet, switching points).</li> <li>• Check that other pumps function.</li> </ul>
E141.x	Pump running time monitoring***	From 2.xx.x	Maximum running time of the pump exceeded	<ul style="list-style-type: none"> <li>• Check the operating parameters (inlet, switching points).</li> <li>• Check that other pumps function.</li> </ul>

**Key:**

\*\*"x" = represents the pump to which the fault shown applies!

\*\* Fault must be **manually** acknowledged in ex-mode!

\*\*\* Fault must **generally be manually** acknowledged.

**11.6 Further steps for troubleshooting**

If the points listed here do not rectify the fault, please contact customer service. Costs may be incurred if other services are used. For more details, please contact customer service.

**12 Disposal****12.1 Rechargeable battery**

Do not dispose of rechargeable batteries in domestic waste and remove them before product disposal. End consumers are legally obliged to return all used rechargeable batteries. For this purpose, you can return used rechargeable batteries free of charge at municipal collection points or specialist retailers.

**NOTICE****Disposal in domestic waste is prohibited!**

Affected rechargeable batteries are marked with this symbol. The identifier for the heavy metal they contain is displayed beneath the graphic:

- **Hg** (mercury)
- **Pb** (lead)
- **Cd** (cadmium)

## 12.2 Information on the collection of used electrical and electronic products

Proper disposal and appropriate recycling of this product prevents damage to the environment and putting your personal health at risk.



### NOTICE

#### Disposal in domestic waste is prohibited!

In the European Union this symbol may be included on the product, the packaging or the accompanying documentation. It means that the electrical and electronic products in question must not be disposed of along with domestic waste.

Please note the following points to ensure proper handling, recycling and disposal of the used products in question:

- Hand over these products at designated, certified collection points only.
- Observe the locally applicable regulations!

Please consult your local municipality, the nearest waste disposal site, or the dealer who sold the product to you for information on proper disposal. See [www.wilo-recycling.com](http://www.wilo-recycling.com) for more information about recycling.

#### Subject to change without prior notice!

## 13 Appendix

### 13.1 Potentially explosive atmospheres: Connection of signal transmitters and pumps



#### DANGER

#### Risk of explosion if the switchgear is installed in potentially explosive areas!

The switchgear does not have its own explosion protection class and must always be installed outside of potentially explosive areas! The connection must be made by a qualified electrician.

#### 13.1.1 Ex-zones

The connected pumps and signal transmitters may only be used in the ex-zones 1 and 2.  
**Use in ex-zone 0 is prohibited!**

#### 13.1.2 Pumps

- Pumps comply with the ignition protection class “flameproof enclosure”.
- Connect pumps directly to the switchgear. The use of electronic start-up controllers is prohibited!
- Connect monitoring devices outside of the flameproof enclosure via a cut-off relay (Ex-i, intrinsically safe circuit).

#### 13.1.3 Signal transmitter



#### DANGER

#### Risk of explosion due to incorrect signal transmitter!

Do not connect electrode in an explosive atmosphere (Ex zone)! There is a risk of explosion!  
Always use float switch or level sensor in explosive atmospheres (ex zone).

Connect signal transmitters in explosive atmospheres via an intrinsically safe circuit:

- Connect the float switch using an Ex cut-off relay!
- Connect level sensor via a Zener barrier!

### 13.1.4 Connection, thermal motor monitoring

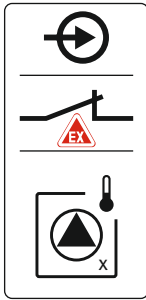

Fig. 76: Overview of connections, terminal layout

### 13.1.5 Dry-running protection connection

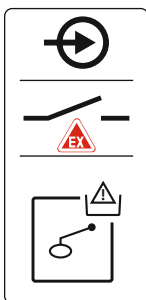

Fig. 77: Overview of connections, terminal layout

### 13.1.6 Switchgear configuration: Switching on ex-mode

Connect the bimetallic strip to the terminal strip for active ex-mode (see Overview of components [▶ 14], item 4b). **Use the terminal number shown in the connection overview on the cover.** The “x” in the symbol states the respective pump.

#### See also

- ▶ Overview of components [▶ 14]

### **DANGER! Risk of explosion due to incorrect execution! Monitoring of the dry-running level must be performed with a separate float switch!**

Connect the float switch to the terminal strip for active ex-mode (see Overview of components [▶ 14], item 4b). **Use the terminal number shown in the connection overview on the cover.**

#### See also

- ▶ Overview of components [▶ 14]

#### Adapted functions

Ex-mode adapts the following functions:

- Follow-up times  
All follow-up times are ignored and the pumps switched off immediately!
- Dry-running level (by level sensor or dynamic pressure bell)  
The following actions are only possible once the “All pumps off” fill level has been exceeded:
  - Reactivation of the pumps
  - Resetting the error message
- Alarm dry-running protection (via float switch)  
Alarm manual reset (anti-reactivation lock)!
- Alarm thermal motor monitoring  
Alarm manual reset (anti-reactivation lock)!

#### Activating ex-mode

1. Press the operating button for 3 s.  
⇒ Menu 1.00 appears.
2. Turn the operating button until menu 5 appears.
3. Press the operating button.  
⇒ Menu 5.01 appears.
4. Turn the operating button until menu 5.64 appears.
5. Press the operating button.
6. Change the value to “on”: Turn the operating button.
7. Press the operating button.  
▶ Ex-mode switched on.

13.2 System impedances



**NOTICE**

**Maximum switching frequency per hour**

The connected motor determines the maximum switching frequency per hour. Note the technical data of the connected motor! The maximum switching frequency of the motor must not be exceeded.



**NOTICE**

- Depending on the system impedance and the maximum connections/hour of the connected consumers, voltage fluctuations and/or drops may occur.
- When using shielded cables, attach the shielding to the earth rail on one side of the switchgear!
- Always have connection carried out by a qualified electrician!
- Observe the installation and operating instructions for the connected pumps and signal transmitters.

3~400 V, 2-pole, direct starting		
Power in kW	System impedance in ohm	Connections/h
2.2	0.257	12
2.2	0.212	18
2.2	0.186	24
2.2	0.167	30
3.0	0.204	6
3.0	0.148	12
3.0	0.122	18
3.0	0.107	24
4.0	0.130	6
4.0	0.094	12
4.0	0.077	18

13.3 Overview of the symbols



Standby:  
Symbol lights up: The switchgear is switched on and ready for operation.  
Symbol flashing: Follow-up time of pump 1 active



Value input not possible:  
1. Input disabled  
2. The accessed menu only displays values.



Pumps ready for operation/deactivated:  
Symbol lights up: Pump is available and ready for operation.  
Symbol flashing: Pump is deactivated.



Pumps working/fault:  
Symbol lights up: Pump is in operation.  
Symbol flashing: Pump fault



A pump has been set as the standby pump.



“Extern OFF” input active: All pumps switched off



Operating mode: “drain”



Operating mode: “fill”



High water level reached



**Operating mode “drain”:** Dry-running level too low



**Operating mode “fill”:** Level for low water too low  
There is at least one current (unacknowledged) error message.



The device communicates using a field bus system.

13.4 Terminal diagram overview

Wiring diagram EC-L1... and EC-L2...

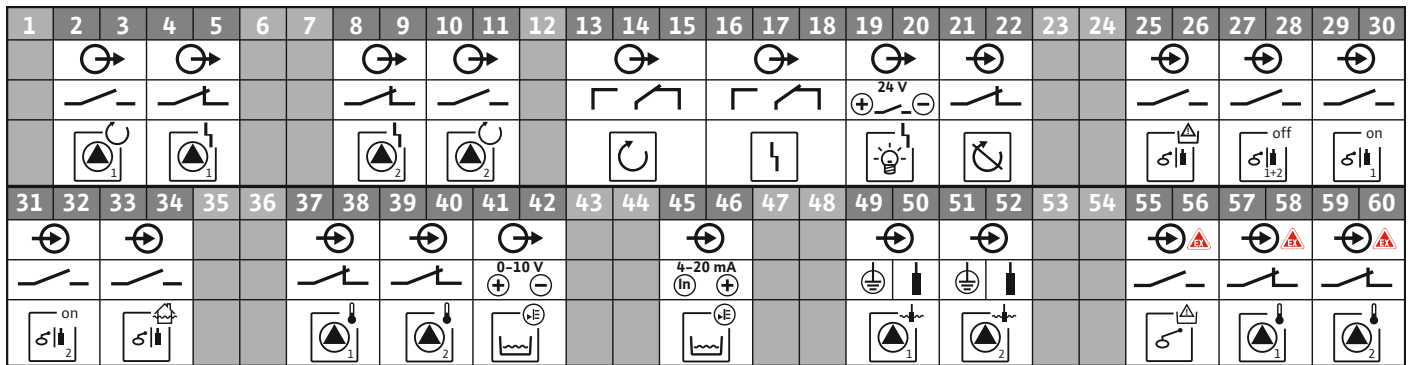

Terminal	Function	Terminal	Function
2/3	Output: Individual run signal pump 1	31/32	Input: Float switch or electrode "pump 2 in"
4/5	Output: Individual fault signal pump 1	33/34	Input: "High water" float switch or electrode
8/9	Output: Individual fault signal pump 2	37/38	Input: Pump 1 thermal winding monitor
10/11	Output: Individual run signal pump 2	39/40	Input: Pump 2 thermal winding monitor
13/14/15	Output: Collective run signal	41/42	Output: Analogue output for displaying the actual level value
16/17/18	Output: Collective fault signal	45/46	Input: Level sensor 4 – 20 mA
19/20	Output: Power output	49/50	Input: Leakage detection pump 1
21/22	Input: Extern OFF	51/52	Input: Leakage detection pump 2
25/26	Input: "Dry-running protection" float switch or electrode	55/56	Input: "Dry-running protection" float switch (ex-mode)
27/28	Input: "All pumps off" float switch or electrode	57/58	Input: Thermal winding monitor pump 1 (ex-mode)
29/30	Input: Float switch or electrode "pump 1 in"	59/60	Input: Thermal winding monitor pump 2 (ex-mode)

Terminal diagram EC-L3...

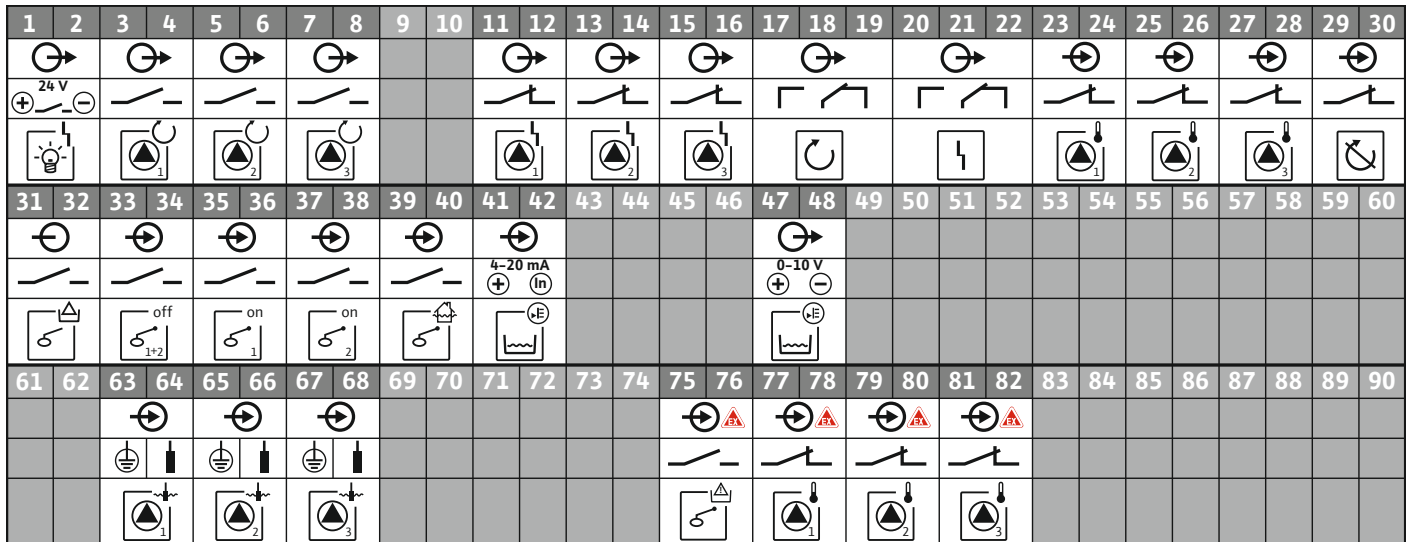

Terminal	Function	Terminal	Function
1/2	Output: Power output	33/34	Input: "All pumps off" float switch
3/4	Output: Individual run signal pump 1	35/36	Input: "Pump 1 on" float switch
5/6	Output: Individual run signal pump 2	37/38	Input: "Pump 2 on" float switch
7/8	Output: Individual run signal pump 3	39/40	Input: "High water" float switch
11/12	Output: Individual fault signal pump 1	41/42	Input: Level sensor 4 – 20 mA
13/14	Output: Individual fault signal pump 2	47/48	Output: Analogue output for displaying the actual level value
15/16	Output: Individual fault signal pump 3	63/64	Input: Leakage detection pump 1
17/18/19	Output: Collective run signal	65/66	Input: Leakage detection pump 2



Terminal	Function	Terminal	Function
20/21/22	Output: Collective fault signal	67/68	Input: Leakage detection pump 3
23/24	Input: Pump 1 thermal winding monitor	75/76	Input: "Dry-running protection" float switch (ex-mode)
25/26	Input: Pump 2 thermal winding monitor	77/78	Input: Thermal winding monitor pump 1 (ex-mode)
27/28	Input: Pump 3 thermal winding monitor	79/80	Input: Thermal winding monitor pump 2 (ex-mode)
29/30	Input: Extern OFF	81/82	Input: Thermal winding monitor pump 3 (ex-mode)
31/32	Input: "Dry-running protection" float switch		

### 13.5 ModBus: Data types

Data type	Description
INT16	Integer in the range from -32768 to 32767. The number range actually used for a data point may vary.
UINT16	Unsigned integers in the range from 0 to 65535. The number range actually used for a data point may vary.
ENUM	Is a list. Only one of the values listed in the parameters can be set.
BOOL	A Boolean value is a parameter with exactly two states (0 – false and 1 – true). Generally, all values greater than zero are classified as true.
BITMAP*	Is an array of 16 Boolean values (bits). Values are indexed from 0 to 15. The number read from or written to the register is the sum of all bits with the value 1 multiplied by 2 to the power of its index. <ul style="list-style-type: none"> <li>• Bit 0: <math>2^0 = 1</math></li> <li>• Bit 1: <math>2^1 = 2</math></li> <li>• Bit 2: <math>2^2 = 4</math></li> <li>• Bit 3: <math>2^3 = 8</math></li> <li>• Bit 4: <math>2^4 = 16</math></li> <li>• Bit 5: <math>2^5 = 32</math></li> <li>• Bit 6: <math>2^6 = 64</math></li> <li>• Bit 7: <math>2^7 = 128</math></li> <li>• Bit 8: <math>2^8 = 256</math></li> <li>• Bit 9: <math>2^9 = 512</math></li> <li>• Bit 10: <math>2^{10} = 1024</math></li> <li>• Bit 11: <math>2^{11} = 2048</math></li> <li>• Bit 12: <math>2^{12} = 4096</math></li> <li>• Bit 13: <math>2^{13} = 8192</math></li> <li>• Bit 14: <math>2^{14} = 16384</math></li> <li>• Bit 15: <math>2^{15} = 32768</math></li> </ul>
BITMAP32	Is an array of 32 Boolean values (bits). Please check Bitmap for the calculation details.

\* Example for clarification:

Bit 3, 6, 8, and 15 are 1. All others are 0. The sum is then  $2^3 + 2^6 + 2^8 + 2^{15} = 8 + 64 + 256 + 32768 = 33096$ . It is also possible to do the calculation the other way round. Based on the bit with the highest index, check whether the read number is greater than/equal to the power of two. If this is the case, bit 1 is set and the power of two is deducted from the number. Then the check with the bit with the next lower index and the recently calculated residual number is repeated until bit 0 is obtained or the residual number is zero. Example for clarification: The read number is 1416. Bit 15 will be 0, since  $1416 < 32768$ . Bits 14 to 11 will also be 0. Bit 10 will be 1, since  $1416 > 1024$ . The remainder will be  $1416 - 1024 = 392$ . Bit 9 will be 0, since  $392 < 512$ . Bit 8 will be 1, since  $392 > 256$ . The remainder will be  $392 - 256 = 136$ . Bit 7 will be 1, since  $136 > 128$ . The remainder will be  $136 - 128 = 8$ . Bits 6 to 4 will be 0. Bit 3 will be 1, since  $8 = 8$ . The remainder will be 0. The remaining bits 2 to 0 will thus all be 0.

### 13.6 ModBus: Parameter overview

Holding register (Protocol)	Name	Data type	Scale & unit	Elements	Access*	Added
40001 (0)	Version communication profile	UINT16	0.001		R	31,000
40002 (1)	Wink service	BOOL			RW	31,000

Holding register (Protocol)	Name	Data type	Scale & unit	Elements	Access*	Added
40003 (2)	Switch box type	ENUM		0. SC 1. SC...FC 2. SCe 3. CC 4. CC...FC 5. CCe 6. SCe NWB 7. CCe NWB 8. EC 9. ECe 10. ECe NWB	R	31,000
40014 (13)	Bus command timer	ENUM		0. - 1. Off 2. Set 3. Active 4. Reset 5. Manual	RW	31,000
40015 (14)	Drives on/off	BOOL			RW	31,000
40025 (24)	Control mode	ENUM		0. p-c 1. dp-c 2. dp-v 3. dT-c 4. dT-v 5. n(TV) 6. n(TR) 7. n(TP) 8. n(TA) 9. n-c 10. fill 11. empty/drain 12. FTS 13. cleans/day 14. cleans/ month	R	31,000
40026 (25)	Current value	INT16	0.1 bar 0.1 m 0.1 K 0.1 °C 1 cm 1 min 0.1 h 0.1 psi		R	31,000
40041 (40)	Pump 1 mode	ENUM		0. Off 1. Hand 2. Auto	RW	31,000
40042 (41)	Pump 2 mode	ENUM		0. Off 1. Hand 2. Auto	RW	31,000
40043 (42)	Pump 3 mode	ENUM		0. Off 1. Hand 2. Auto	RW	31,000
40062 (61)	Switch box state	BITMAP		0: SBM 1: SSM	R	31,000

Holding register (Protocol)	Name	Data type	Scale & unit	Elements	Access*	Added
40139 - 40140 (138-139)	Error state	BITMAP32		0: Sensor error 1: P max 2: P min 3: FC 4: TLS 5: Pump 1 Alarm 6: Pump 2 Alarm 7: Pump 3 Alarm 8: Pump 4 Alarm 9: Pump 5 Alarm 10: Pump 6 Alarm 11: - 12: - 13: Frost 14: Battery Low 15: High water 16: Priority off 17: Redundancy 18: Plausibility 19: Slave communication 20: Net supply 21: Leakage	R	31,000
40141 (140)	Acknowledge	BOOL			W	31,000
40142 (141)	Alarm history index	UINT16			RW	31,000
40143 (142)	Alarm history error code	UINT16	0.1		R	31,000
40198 (197)	State float swiches	BITMAP		0: DR 1: Ps off 2: P1 on 3: P2 on 4: HW	R	31.102
40204 (203)	Set points water level 1	UNIT16	1 cm		RW	31.102
40205 (204)	Set points water level 2	UNIT16	1 cm		RW	31.102
40206 (205)	Set points water level 3	UNIT16	1 cm		RW	31.102
40212 (211)	Set points water level 1	UNIT16	1 cm		RW	31.102
40213 (212)	Set points water level 2	UNIT16	1 cm		RW	31.102
40214 (213)	Set points water level 3	UNIT16	1 cm		RW	31.102
40220 (219)	Dry run level	UNIT16	1 cm		RW	31.102
40222 (221)	High water level	UNIT16	1 cm		RW	31.102

**Key**

\* R = read-only, RW = read- and write-accessible









# wilo



Local contact at  
[www.wilo.com/contact](http://www.wilo.com/contact)

Pioneering for You

WILO SE  
Wilopark 1  
44263 Dortmund  
Germany  
T +49 (0)231 4102-0  
T +49 (0)231 4102-7363  
[wilo@wilo.com](mailto:wilo@wilo.com)  
[www.wilo.com](http://www.wilo.com)