



A WILO COMPANY

MOTORPUMP™ — 3500 RPM

Bronze, 60 Hz, 2.5 X 2.0 X 6.5 NPT

52B JM



Motor Dimensions										
HP	Type	Frame	D	E	F	O	AB	BG	L	MH
3	ODP	JM145	3.50	2.75	2.50	6.77	5.61	5.38	4.12	0.34
5	ODP	JM182	4.50	3.75	2.25	8.44	6.74	5.75	5.12	0.41
7.5	ODP	JM184	4.50	3.75	2.25	8.44	6.74	5.75	6.56	0.41
10	ODP	JM213	5.25	4.25	2.75	10.03	7.92	7.00	6.94	0.43
3	TEFC	JM182	4.50	3.75	2.25	8.85	7.57	5.01	7.14	0.41
5, 7.5	TEFC	JM184	4.50	3.75	2.75	9.34	7.57	5.51	7.64	0.41
10	TEFC	JM215	5.25	4.25	3.50	10.37	8.19	6.77	9.16	0.41

DRAWING DEPICTS 5HP JM182 ODP MOTOR
ALL DIMENSIONS IN INCHES

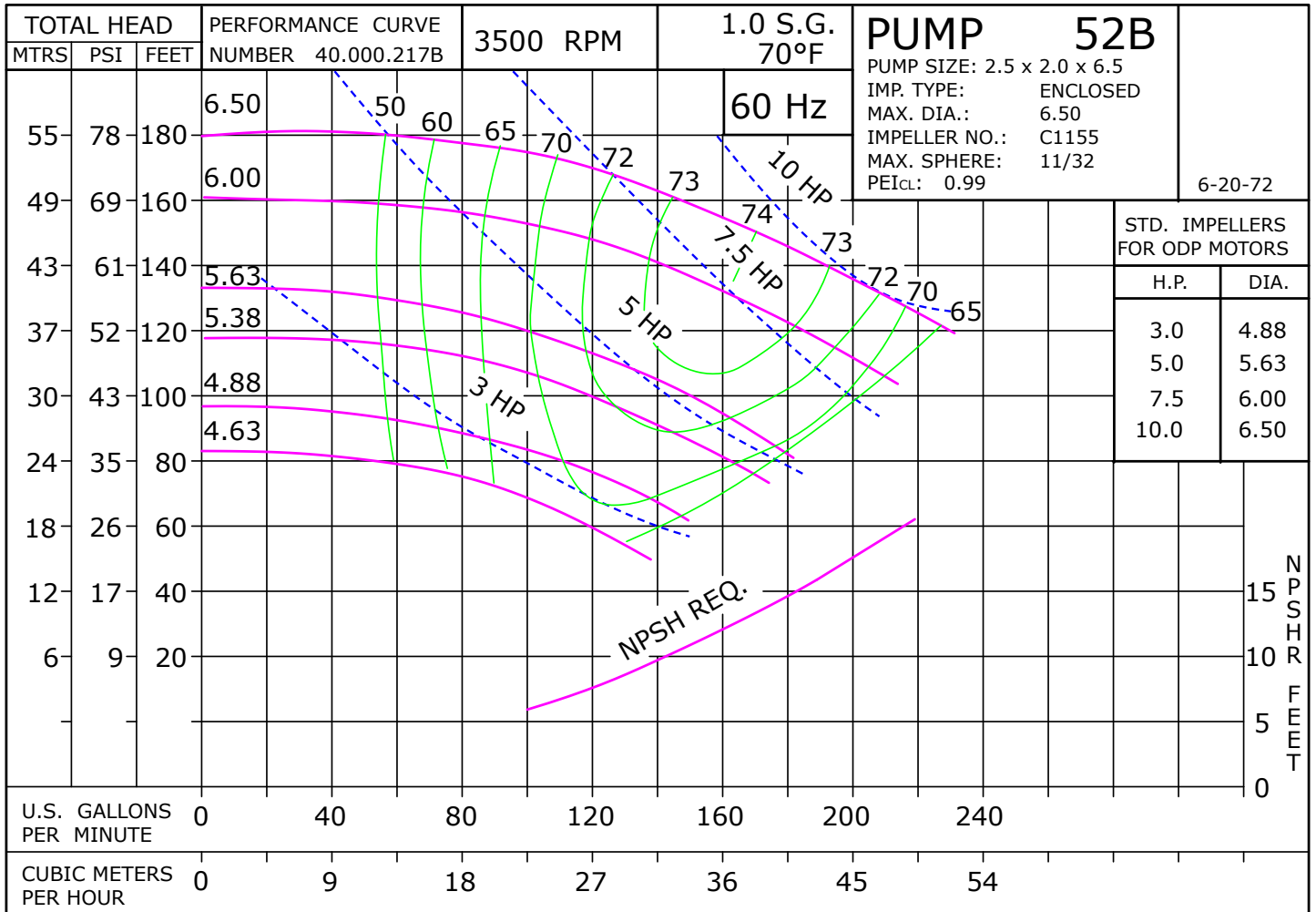
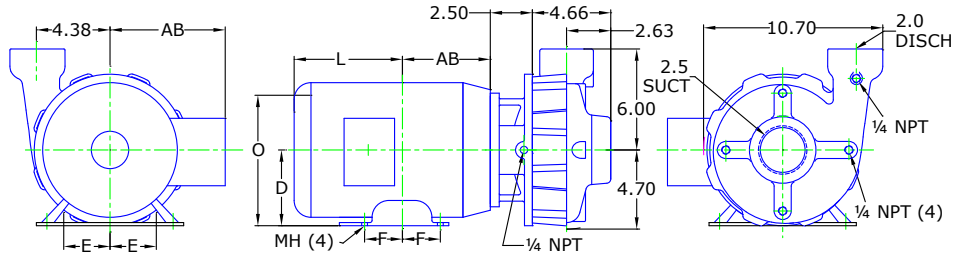

Parts

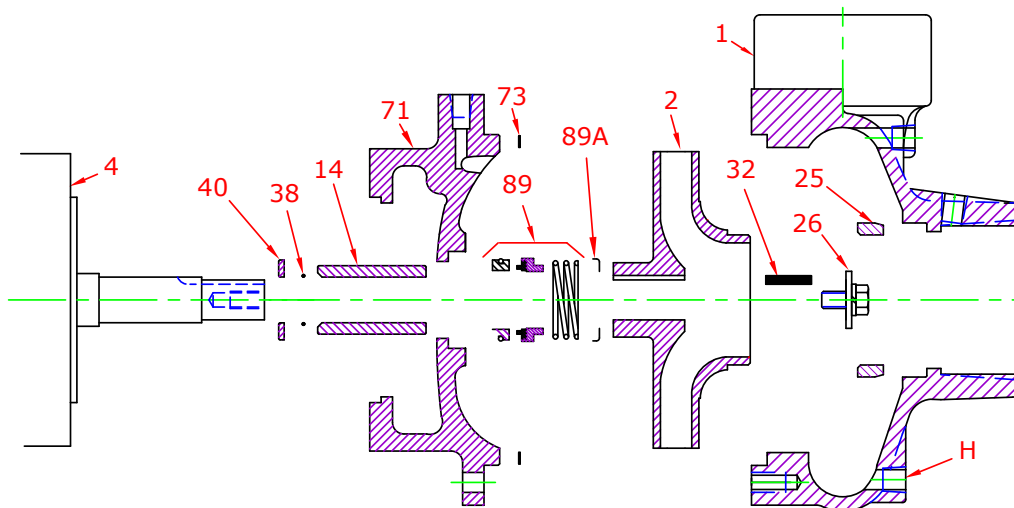

Key No.	Part Name	Part Number
1	Case 52B, Bronze, 2.50 X 2.00 NPT Bronze wear ring and plugs	130.000.218X
2	Impeller 52, Bronze Specify Dia., 6.50 Max 7/8" Key	131.000.810
4	Motor chart, JM140/180	See Chart
	Motor chart, JM210	See Chart
14*	Shaft sleeve, Bronze	110.000.178
	Shaft sleeve, Stainless	110.000.192
25	Wear ring, Bronze	103.000.136
26*	Impeller retaining assembly, Stainless	118.000.163A
32*	Key, Stainless	102.000.102
38*	O-ring, Shaft, Buna	116.000.117
	O-ring, Shaft, Viton	116.000.105
40*	Flinger, Stainless	104.000.165
71	Adapter, Bronze, JM140/180 1-1/2" Seal, with Brass plug	132.000.228X
	Adapter, Bronze, JM210 1-1/2" Seal, with Brass plug	132.000.223X
73*	Gasket, Case, Fiber	116.000.157
89*	Seal, 1-1/2", Type 21, BN-CARB/CM	101.000.168
	Seal, 1-1/2", Type 21, EPDM-CARB/SIL	101.000.175B
	Seal, 1-1/2", Type 21, EPDM-SIL/SIL	101.000.204A
	Seal, 1-1/2", Type 21, VN-CARB/CM	101.000.191
	Seal, 1-1/2", Type 21, VN-CARB/SIL	101.000.175
	Seal, 1-1/2", Type 21, VN-SIL/SIL	101.000.204
89A*	Seal spring retainer, Stainless	104.000.174
KIT	Repair Kit, 1-1/2" BN-CARB/CM Seal, Brz sleeve, BN O-ring	118.000.344
	Repair Kit, 1-1/2" EPDM-CARB/SIL Seal, Brz sleeve, BN O-ring	118.000.344C
	Repair Kit, 1-1/2" EPDM-SIL/SIL Seal, Brz sleeve, BN O-ring	118.000.344D
	Repair Kit, 1-1/2" VN-CARB/CM Seal, Brz sleeve, BN O-ring	118.000.344K
	Repair Kit, 1-1/2" VN-CARB/CM Seal, Stn sleeve, VN O-ring	118.000.344A
	Repair Kit, 1-1/2" VN-CARB/SIL Seal, Brz sleeve, BN O-ring	118.000.344B
	Repair Kit, 1-1/2" VN-SIL/SIL Seal, Stn sleeve, VN O-ring	118.000.344F

* Denotes components included in repair kit.

Motor Charts

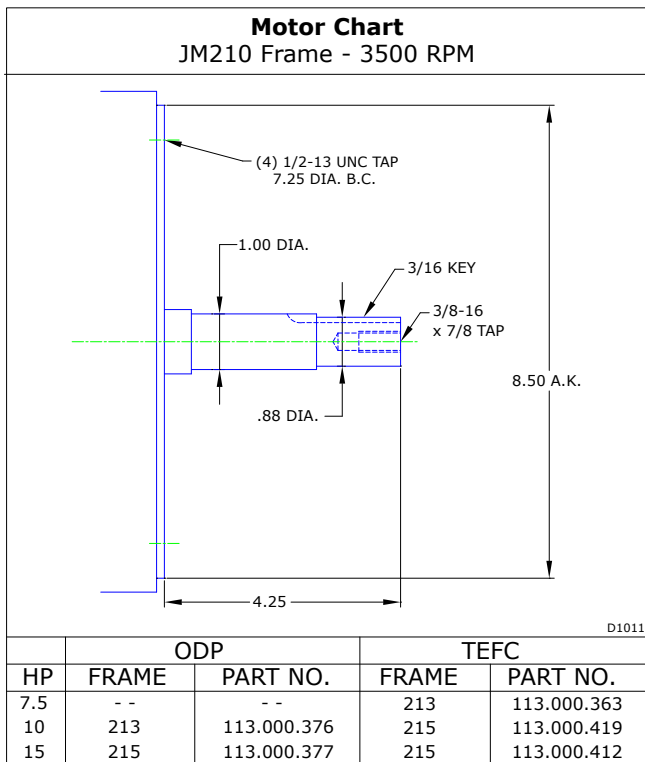
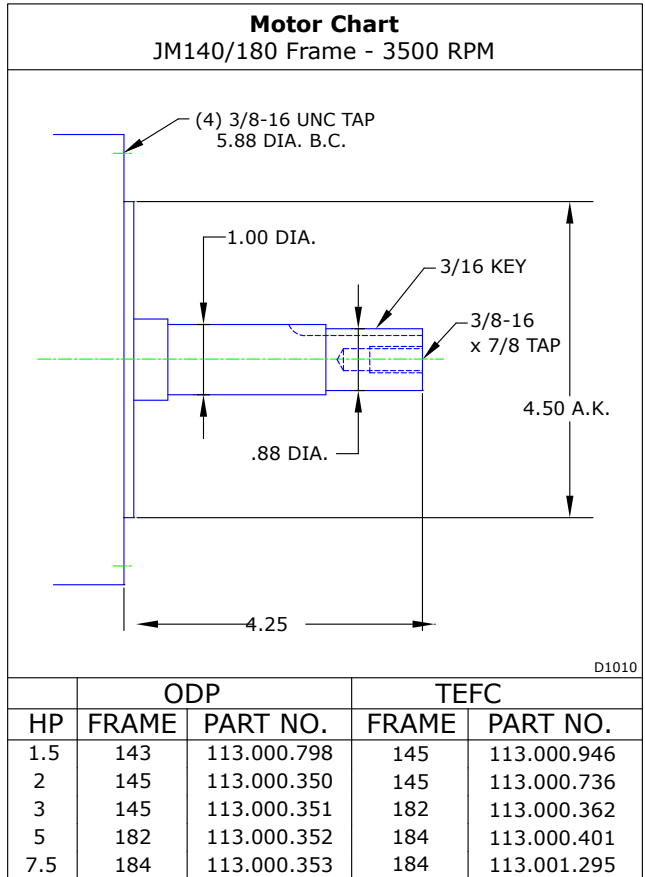

Construction Options

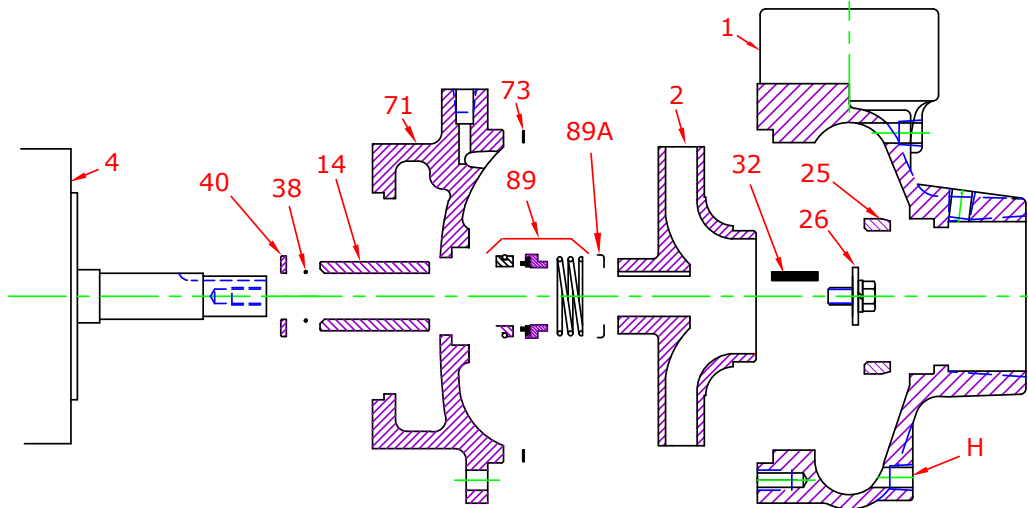

Construction Options		
Key No.	Part Name	All Bronze
1	Case	Bronze
2	Impeller	Bronze
14	Shaft Sleeve	Bronze
25	Wear Ring	Bronze
26	Impeller Retaining Assy	Stainless
32	Key	Stainless
38	Shaft O-Ring	Buna
40	Flinger	Stainless
71	Adapter	Bronze
73	Gasket, Case	Fiber
89	Mechanical Seal, Type 21 BN-CM	Standard
89A	Seal Spring Retainer	Stainless
H	Plug, Drain	Brass