

Durability By Design Since 1873



2023 Product Brochure

300 Series REC, REI, REF

Close & Flex-Coupled/Inline End Suction Pumps

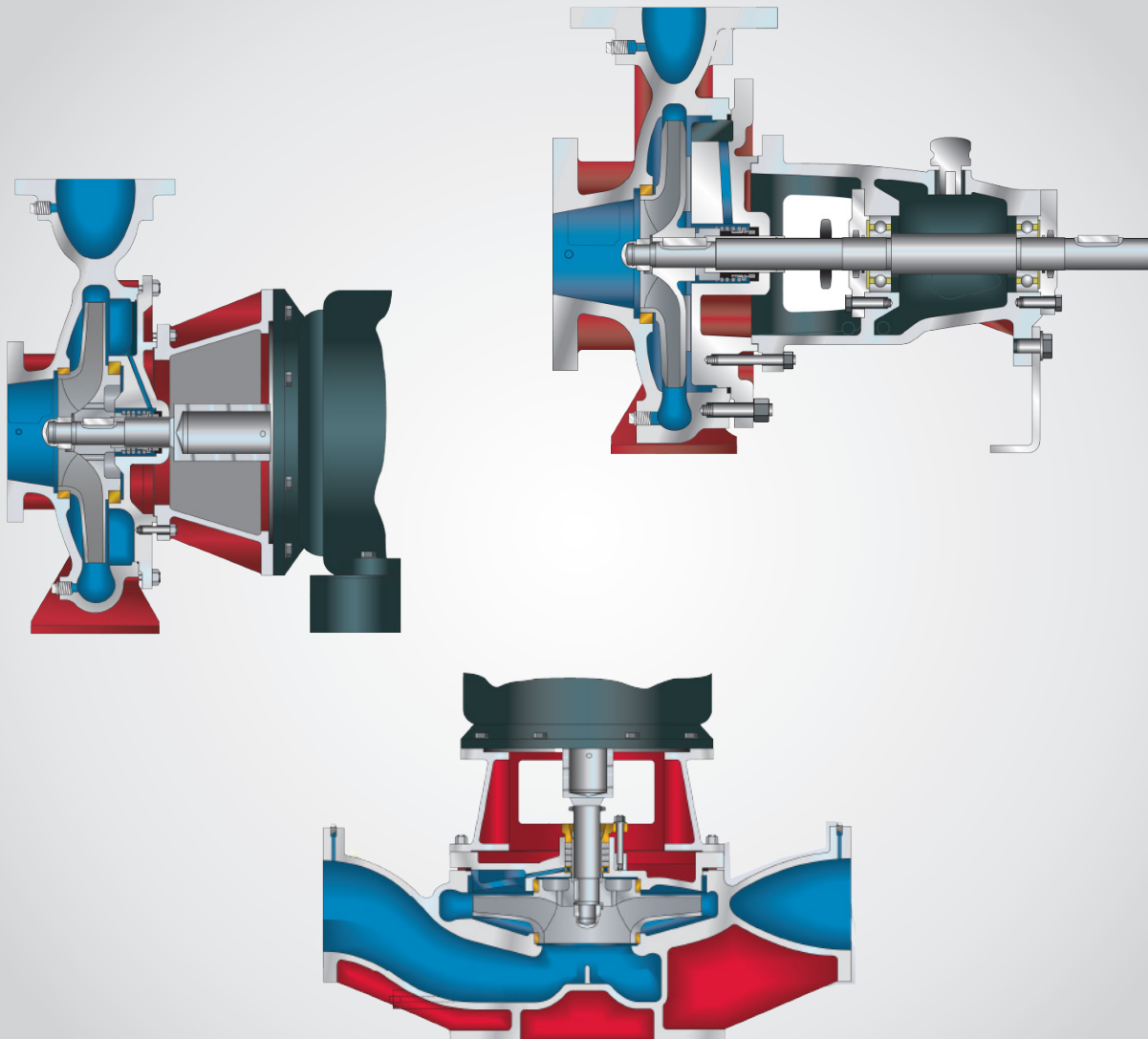

300 Series

REC Close-Coupled & REF Flex-Coupled End Suction Pumps

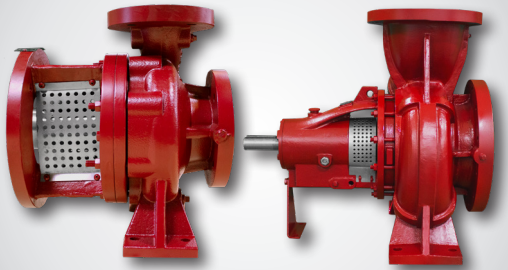

Applications

- Agriculture & Irrigation
- Commercial
- Industrial
- Municipal
- Circulation
- Booster
- HVAC

Max Head: 450 feet

Max. Flow: 9,000 GPM

Features & Benefits

- Back pull-out design
- Replaceable case wear rings
- Internal plan 1 seal flush
- CL 250 cast flanges drilled to CL 125
- Centerline discharge
- Integral feet on casing
- Suction & discharge flanges drilled & tapped for gauges
- Standard T-frame motors on flex-coupled models
- REC & REI close-coupled utilize standard C-face T-frame motors
- REF base mounted, flex-coupled

Technical Data

- Temperatures up to 180°F
- Discharge sizes: 1.25" - 12"

Materials of Construction

- Cast Iron
- Stainless Steel fitted
- 810 component seal

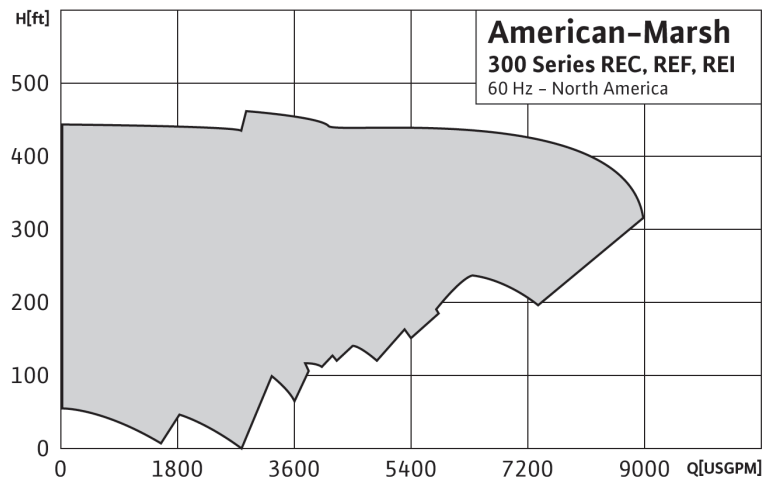

300 Series

REI Vertical Inline End Suction Pumps



Applications

- Agriculture & Irrigation
- Commercial
- Industrial
- Municipal
- Circulation
- Booster
- HVAC

Max Head: 450 feet

Max. Flow: 9,000 GPM

Features & Benefits

- Back pull-out design
- Replaceable case wear rings
- Internal plan 1 seal flush
- CL 250 cast flanges drilled to CL 125
- Centerline discharge
- Integral feet on casing
- Suction & discharge flanges drilled & tapped for gauges
- REC & REI close-coupled utilize standard C-face T-frame motors

Technical Data

- Temperatures up to 180°F
- Discharge sizes: 2" - 12"

Materials of Construction

- Cast Iron
- Stainless Steel fitted
- 810 Component seal

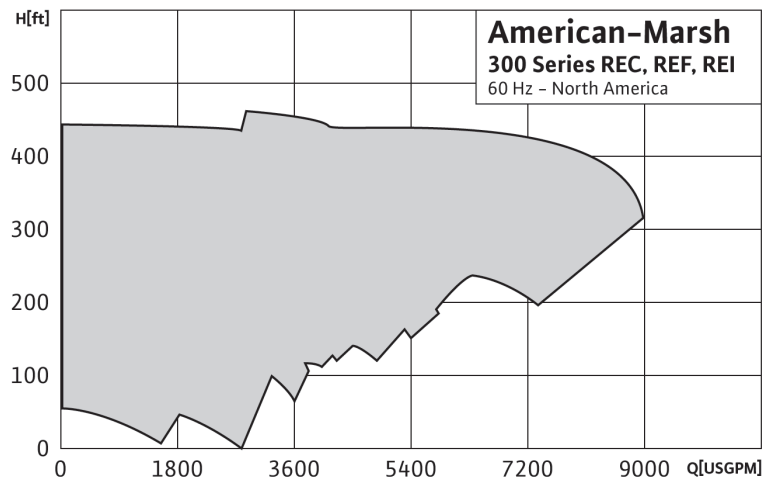



AMERICAN-MARSH PUMPS

A WILO BRAND

Durability By Design Since 1873

WILO USA LLC

+1 262-204-6600

www.wilo-usa.com

info.us@wilo-usa.com

American-Marsh Pumps

+1 901-860-2300

www.american-marsh.com

amp.cs@wilo.com