

Pioneering for You

wilo

Wilo brings the future.

Wilo General Catalogue Water Management

Explore our solutions for Water Supply, Drainage and Sewage

DISCOVER
ADDITIONAL
DIGITAL
CONTENT



WILO BRINGS THE FUTURE.

Ground-breaking solutions for an ever more complex world.

Water management worldwide faces complex tasks. Scarcity of resources and urbanisation require efficient systems to reliably transport and treat water. The key question is: what might the sustainable, effective water infrastructure of tomorrow look like? We do not have just the one answer, but a whole range – each individually tailored to each project. As a solutions provider we assist our customers in a holistic manner, from planning to maintenance and support them with intelligent networking during digitisation.



For more information visit www.wilo.com

Pioneering for You

wilo

Clean Water Utility

Highlight products

Raw Water Intake	Wilo-Actun OPTI-MS	8
	Wilo-Actun ZETOS-K8/K10	10
	Submersible pumps	12
	Wilo-CronoBloc-BL	18
	Glanded pumps	20

Distribution and boosting	Wilo-SiBoost Smart Helix EXCEL	26
	Pressure boosting systems	28
	Multistage centrifugal pumps	39
	Glanded pumps	46

Wastewater Utility

Highlight products

Wastewater Collection and Transport	Wilo-Rexa SOLID-Q	54
	Pressure drainage system with Nexos Intelligence	56
	Sewage pumps	58
	Wilo-Padus PRO	64
	Wastewater pumps	66
	Lifting units	69
	Pump chambers	71

Wastewater Treatment	Wilo-Flumen EXCEL-TRE	76
	Mixer and wastewater treatment plants	78
	Wilo-Sevio AIR	82
	Wilo-TP Control	88

Service and support	Wilo-Services	90
Spare parts catalogue	The Wilo Spare Parts Catalogue 2018	92
Quickfinder	Overview of all products in this catalogue	93



INTELLIGENT NETWORKING IN THE WORLD OF TOMORROW.

PIONEERING DIGITAL SOLUTIONS FOR WATER MANAGEMENT.

In developing individual solutions, Wilo also seizes the opportunities offered by the latest technological developments and digitalisation. We know that consultants, operators and system manufacturers are up against new challenges all the time: increasing water consumption at increasing solid matter content in the sewage, high energy costs and permanent operational reliability, to name but a few.



Seizing the opportunities offered by digitalisation.

Modern digital technologies offer great potential: digital technology makes it possible to collect relevant data and carry out targeted real-time analyses that are used as the basis for decisions and measures as well as automated decisions. Wilo as the industry's digital pioneer makes this intelligent networking of a water infrastructure's water cycle, users and components makes processes more efficient, flexible and, in particular, sustainable.

We aspire to create the best solution.

Connectivity, operational reliability and maximum efficiency enable operators to increase the efficiency of their systems and achieve valuable savings in costs and resources. Our innovative, intelligent, networked solutions mean you are well prepared for the water management of tomorrow. Our aim is to make your daily work easier.



RAW WATER INTAKE

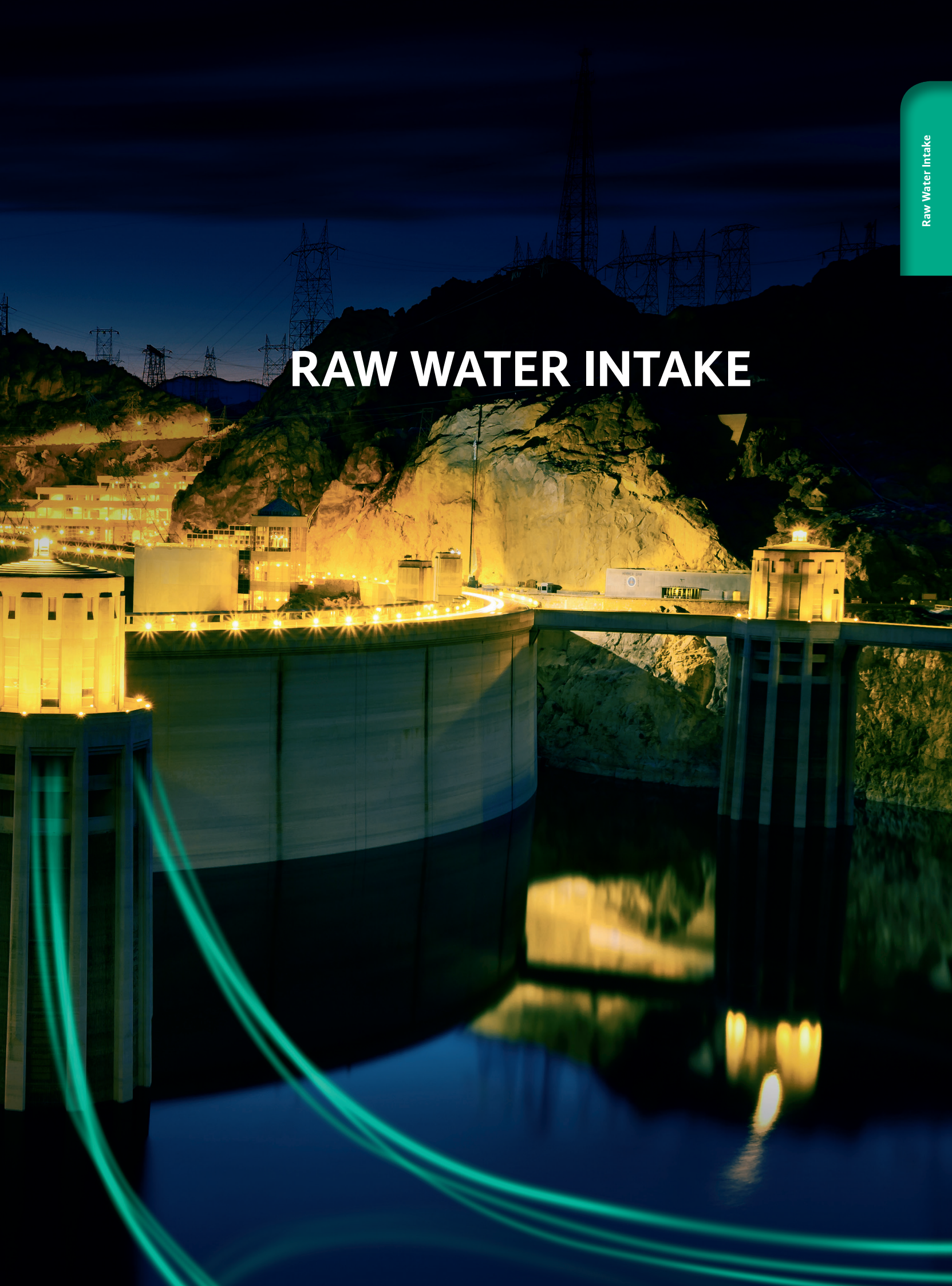

AUTONOMOUS AND OPTIMISED WATER SUPPLY USING SOLAR POWER.

WILO-Actun OPTI-MS



The new Wilo-Actun OPTI is the reliable solution for a fully autonomous water supply, which runs on solar power. The solar-powered submersible pump with integrated frequency converter can free our customers from an unreliable power supply, an unstable power grid as well as the diesel supply problem, which is often very costly and time-consuming. In this way, Wilo-Actun OPTI ensures reliable, cost-effective and sustainable raw water intake. With the help of web-based configuration software, operators can precisely calculate the estimated water output and optimally adjust a pump to suit the operating site, the daily water consumption and the type of photovoltaic modules connected.

From irrigating agricultural land, to livestock farming and supplying small settlements with drinking water, the Wilo-Actun OPTI submersible pump guarantees optimised water output owing to high motor and hydraulic efficiency and dynamic maximum power point tracking (MPPT). The innovative solution gives our customers an invaluable advantage over other solar-powered submersible pumps on the market. For the same solar radiation intensity and the same configuration of photovoltaic modules, Wilo-Actun OPTI can pump more water – and thus supply a larger area, more animals or a larger number of households.

Customer benefits at a glance:

- Fully autonomous and cost-effective water supply by using solar power
- Easy electrical installation by means of integrated frequency converters, without the need to configure parameters
- Optimised output quantity of water owing to high hydraulic and motor efficiencies and dynamic MPPT (maximum power point tracking – guarantees operation of the solar panel at the maximum power point)
- System-specific flexibility owing to a broad performance range
- Increased durability and reliability owing to high-quality materials and an encapsulated motor design
- Extended operational reliability thanks to using integrated protective devices (overheating, dry run, excess current, undervoltage and overvoltage)
- Easy remote access to the operating parameters and settings of the solar submersible pump via the Solar Connect tool in the Wilo-Assistant app
- Alerts via push notifications when the operating status changes



EFFICIENT RAW WATER INTAKE THANKS TO THE HIGHEST LEVELS OF SYSTEM EFFICIENCY.

Wilo-Actun ZETOS-K10



The application-specific, configurable Wilo-Actun ZETOS-K10 has outstanding hydraulic efficiency. If operated with a permanent-magnet motor, the combination of highly efficient hydraulics and a high-efficiency motor facilitates the pumping of water with minimal energy input. The Wilo-Actun ZETOS-K10 thus provides great cost savings. The reduction of operating costs means that the amortisation time is reduced to a minimum, and is currently under two years.

The external frequency converter Wilo-EFC allows variable speed control of the Wilo-Actun ZETOS-K10, meaning that it can be operated optimally – i.e. energy efficiently – at different duty points. Thanks to the flexible control the desired water quantity or the required water pressure are always available.

The Wilo-Actun ZETOS-K10 hydraulics are made entirely from stainless steel investment casting. It has high wear resistance and is suitable for pumping water with sand content of up to 150 g/m³. The highly corrosion-resistant material 1.4408 can even be used in salt water. This makes it particularly robust and suitable for demanding applications.

The submersible pump fulfils the highest demands for the pumping of drinking water, in accordance with the requirements of the German Federal Environment Agency (Umweltbundesamt, UBA) and the French water regulations advisory scheme (Attestation de Conformité Sanitaire, ACS).

The high volume flows and delivery heads that the Wilo-Actun ZETOS-K10 can deliver, sets new standards in terms of 10" submersible pump power density.

Customer benefits at a glance:

- Higher overall efficiency due to a high hydraulic efficiency and permanent-magnet motor
- High reliability thanks to particularly corrosion-resistant hydraulics made completely of 1.4408 grade stainless steel investment casting (AISI 316)
- High wear resistance up to a max. sand content 150 g/m³
- ACS-approved for drinking water applications
- Straightforward maintenance, easy installation and dismantling
- External Wilo-EFC frequency converter for a flexible adaptation of various duty points using fault memory, power meter, continuous speed control and pressure or volume flow control
- Link to the WiloCare service: Transmission of operating data to Wilo and evaluation, including the creation of status reports



WiloCare



Wilo-Actun ZETOS K



Multistage stainless steel cast submersible pump in sectional construction for vertical and horizontal installation

- High pump efficiency of up to 84.5 %
- A previously unequalled total efficiency of more than 75 % in this class with permanent magnet rotor
- Particularly corrosion-resistant thanks to hydraulics comprised entirely of cast stainless steel in 1.4408 (AISI 316)
- High wear resistance: max. sand content of 150 g/m³
- ACS approved for domestic water applications
- Easy maintenance, simple to dismantle system

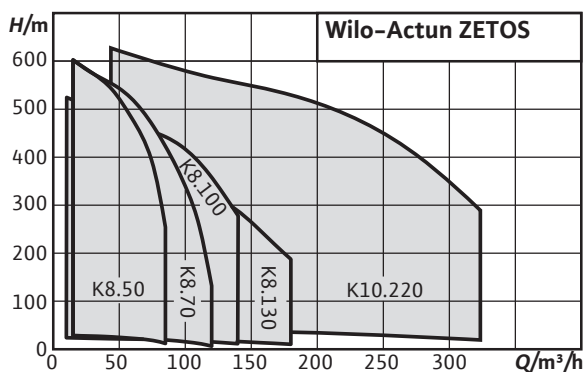

Wilo-Actun OPTI MS



Multistage submersible pump in tie strap version (MSI) or as a progressive cavity pump (MSH) for vertical or horizontal installation

- Fully autonomous and cost-efficient water supply utilising solar power
- Easy electrical installation via integrated frequency converter and without the need for parametrisation
- Optimised water output thanks to high hydraulics and motor efficiencies and dynamic MPPT (Maximum Power Point Tracking – ensures the operation of the solar panel at maximum performance level)
- System-specific flexibility thanks to wide range of services
- Increased durability and reliability through high-quality materials and an encapsulated motor design
- Additional operational reliability by using integrated safety devices

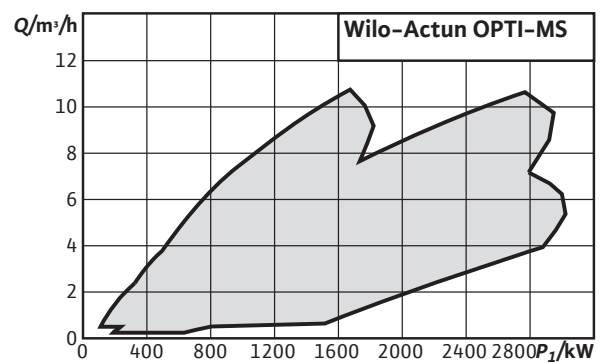



Wilo-Sub TWI 4 -...- QC



Rainwater utilisation, raw water intake

- Quick and easy extension of motor cable, without dismantling the pump
- Easy maintenance due to quick installation and dismantling
- Integrated non-return valve
- Vertical and horizontal installation possible

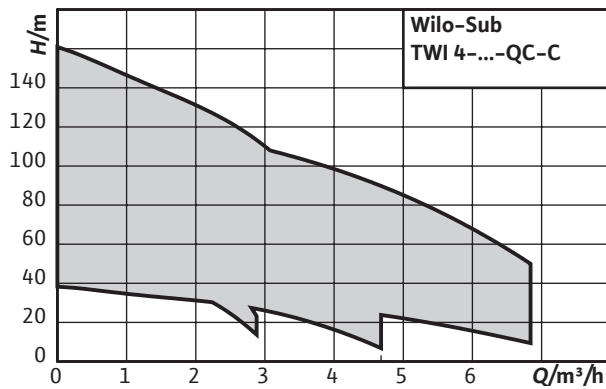

Wilo-Sub TWI 4



Raw water intake

- Long service life thanks to corrosion-resistant stainless steel, optionally in V4A quality
- ACS certified for domestic hot water applications
- A high degree of flexibility thanks to versions in the 4, 6, 8 and 10-inch area
- High range of performance from 1 to 250 m³/h

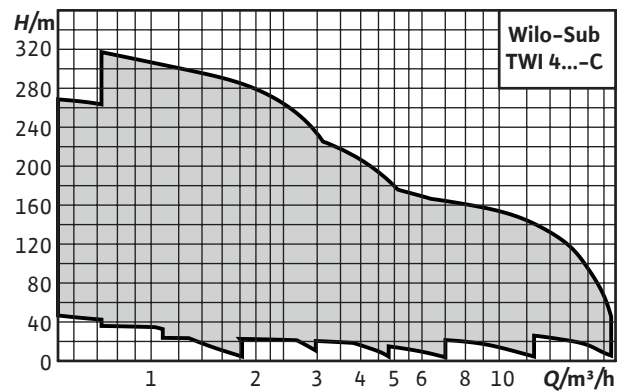



Wilo-Sub TWI 6



Raw water intake

- Long service life thanks to corrosion-resistant stainless steel, optionally in V4A quality
- ACS certified for domestic hot water applications
- A high degree of flexibility thanks to versions in the 4, 6, 8 and 10-inch area
- High range of performance from 1 to 250 m³/h

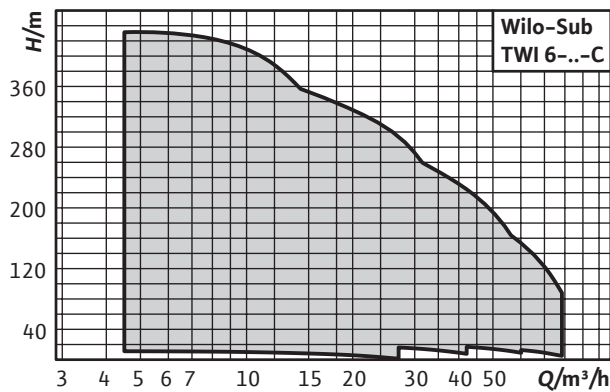

Wilo-Sub TWI 8



Raw water intake

- Long service life thanks to corrosion-resistant stainless steel, optionally in V4A quality
- ACS certified for domestic hot water applications
- A high degree of flexibility thanks to versions in the 4, 6, 8 and 10-inch area
- High range of performance from 1 to 250 m³/h

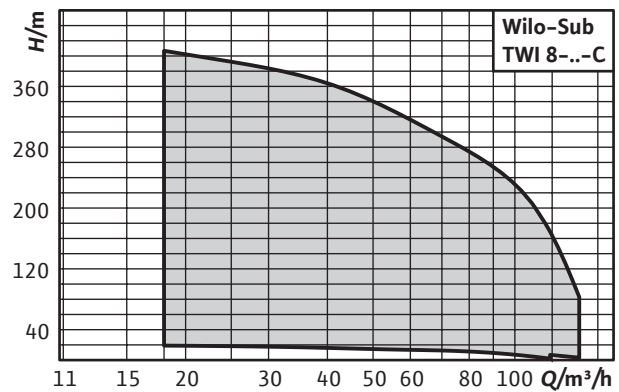



Wilo-Sub TWI 10



Raw water intake

- Long service life thanks to corrosion-resistant stainless steel, optionally in V4A quality
- ACS certified for domestic hot water applications
- A high degree of flexibility thanks to versions in the 4, 6, 8 and 10-inch area
- High range of performance from 1 to 250 m³/h

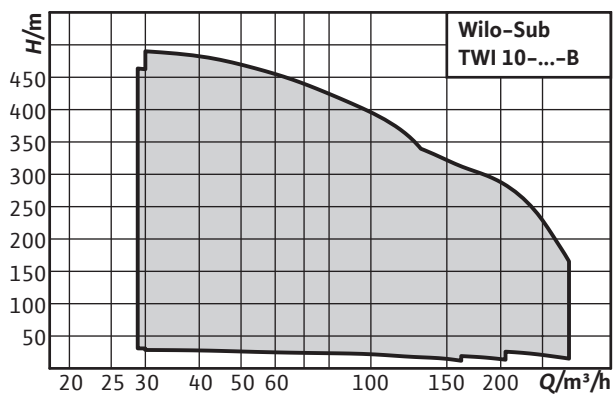

Wilo-EMU 10" ...24"



Water supply/pressure boosting, clean water treatment, raw water intake, desalination, professional irrigation/agriculture

- Pressure shroud in corrosion-resistant and hygienic stainless steel version
- Hydraulic in stainless steel precision casting (Actun ZETOS-K8)
- Maintenance-friendly motors
- Optionally with Ceram CT coating for increasing the efficiency
- Optionally with ACS approval for drinking water application

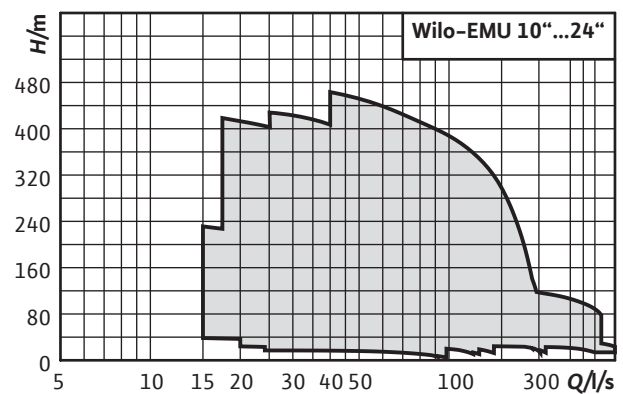



Wilo-EMU-Polderpumpen



Water supply/pressure boosting, clean water treatment, raw water intake, desalination, dewatering, industrial process

- Deep water lowering thanks to self-cooling motors
- Sturdy version in cast iron or bronze
- Compact construction
- Maintenance-friendly, rewindable motors
- Optionally with Ceram CT coating for increasing the efficiency

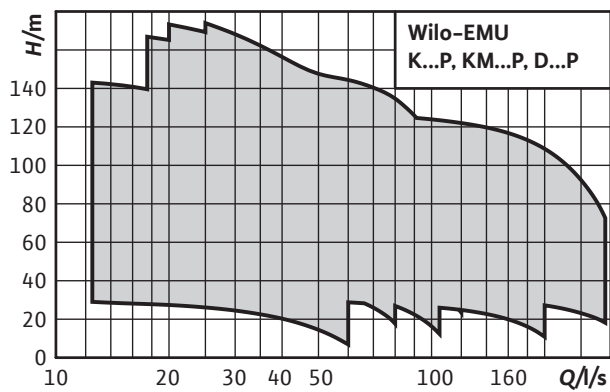



STREAMLINED SOLUTIONS FOR A RELIABLE SUPPLY.

Wilo-CronoBloc-BL



The systematic, reliable, and efficient supply of drinking water for the entire population is one of the most important tasks for a community – both in industrialised and developing countries.

Legal requirements and regulations relating to drinking water are becoming ever more stringent, especially in highly developed countries.

This can be seen in the various certifications for drinking water approval, such as RoHS and ACS.

Increasing demands are therefore being placed on the materials used to manufacture these systems.

At the same time, global megatrends such as urbanisation are escalating the need to rely on ever more efficient systems.

The Wilo-CronoBloc BL has the ACS approval for drinking water supply. In particular in countries such as France and Germany with strict regulations with regard to drinking water, the ACS approval for drinking water applications and the version made of special materials are of great importance. Therefore, this pump is ideal for applications (e.g. back flushing) related to smaller and medium-sized water suppliers.

Thanks to the use of state-of-the-art pump hydraulics, the CronoBloc-BL reaches the highest level of hydraulic efficiency. Combined with efficient IE3 motors, this results in an energy-saving pump with low life-cycle costs.

Advantages for our customers at a glance:

- Energy-saving thanks to state-of-the-art pump hydraulics and the use of IE3 motors
- Suitable for drinking water supply (ACS approved)
- Can be globally used in a wide variety of applications thanks to various impeller materials, several motor options as well as different mechanical seals
- Easy installation due to standard pump support feet and optional supporting blocks
- Easy maintenance and user-friendly design with “back pull-out” design and cartridge mechanical seal for large pump types

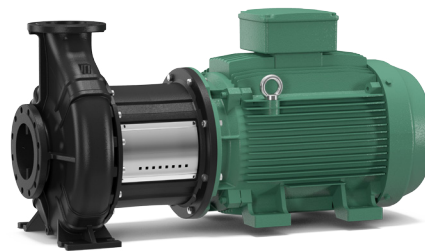

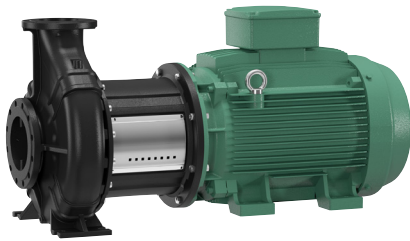

Wilo-CronoBloc-BL



Heating, air conditioning, cooling, industrial process

- Energy-saving thanks to state-of-the-art pump hydraulics and the use of IE3 motors
- Suitable for drinking water supply (ACS approved)
- Can be globally used in a wide variety of applications thanks to various impeller materials, several motor options as well as different mechanical seals
- Easy installation due to standard pump support feet and optional supporting blocks
- Easy maintenance and user-friendly design with “back pull-out” design and cartridge mechanical seal for large pump types

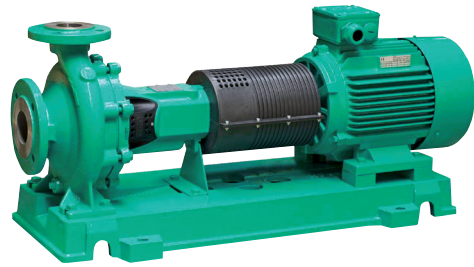
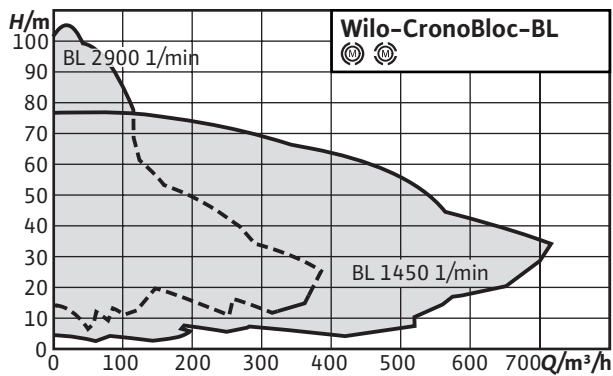

Wilo-CronoNorm-NL

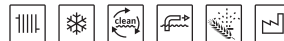

Heating, air conditioning, cooling, water supply, industrial process

- Reduced life-cycle costs through optimised efficiency levels
- Bidirectional, force-flushed mechanical seal
- Low NPSH values, best cavitation properties
- Shaft coupling with or without spacer coupling

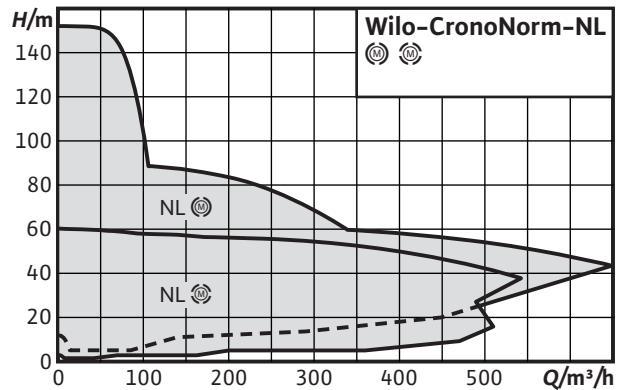

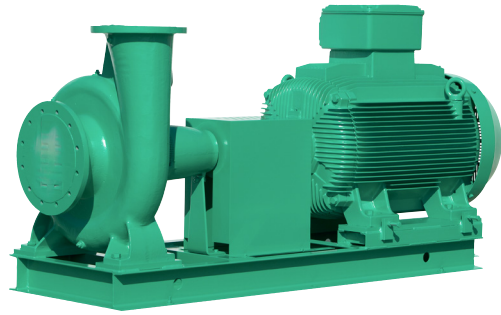
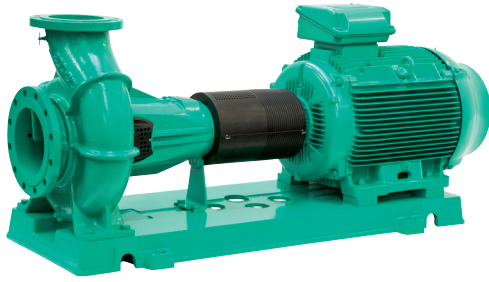

Wilo-CronoNorm-NLG



Heating, air conditioning, cooling, water supply, industrial process

- Reduced life cycle costs thanks to optimized efficiency
- Bidirectional, force-flushed mechanical seal
- Interchangeable casing wear rings
- Permanently lubricated, generously dimensioned roller bearings
- Low NPSH, best cavitation properties

Wilo-VeroNorm NPG



Heating, air conditioning, cooling, industrial process

- Suitable for temperatures up to 140 °C
- Back-pull-out version
- Extension of the DIN EN 733 product range

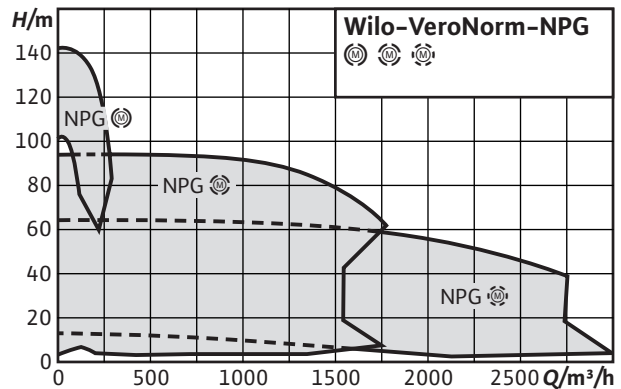
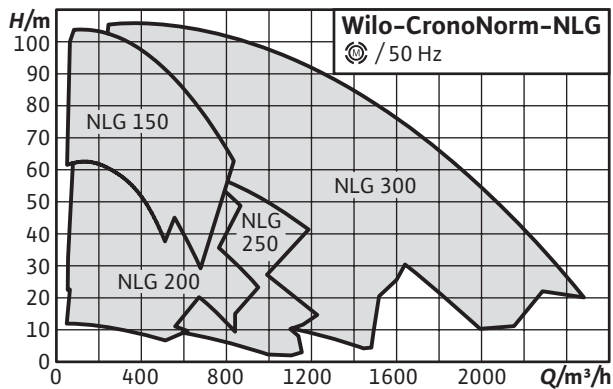

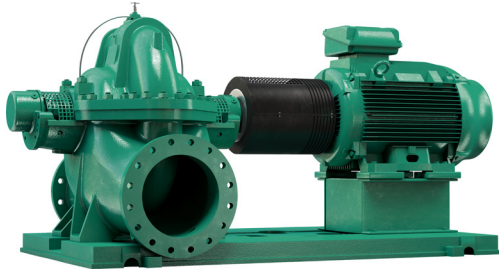

Wilo-SCP



Cooling, air conditioning, water distribution/boosting, industrial process

- Efficient hydraulics for high flow rates up to 17,000 m³/h
- Low NPSH thanks to double suction impeller
- High process reliability and easy maintenance without removing the pressure or suction lines
- Decreased noise level and reduced vibrations
- Options: energy efficient IE3-/IE4 motors, drinking water approval (KTW, ACS), innovative Ceram CT coating



Wilo-Vertical Turbine



Water supply/pressure boosting, industrial process

- Minimum surface area needed
- High hydraulic efficiency
- Submerged pump hydraulics
- Design to order as per customer specifications

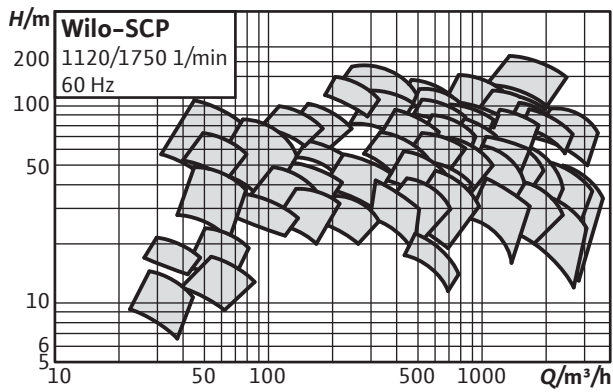





DISTRIBUTION AND BOOSTING

Distribution and boosting



WORKING WITH HIGH PRES- SURE MEANS CONTINUOUS POWER AT THE HIGHEST LEVEL.

Wilo-SiBoost Smart Helix EXCEL



The innovative Wilo-SiBoost Smart Helix EXCEL is highly efficient water-supply unit (non self-priming) ready for connection with 2 to 4 vertically arranged Helix EXCEL stainless steel high-pressure centrifugal pumps switched in parallel; each pump is equipped with an integrated air-cooled, high-efficiency frequency converter and an EC motor, including Smart Controller SCe. Valves and sensors are protected for safe and reliable installation.

Thanks to the interaction of new pump design, high-efficiency hydraulics, and future-proof EC motors, the pumps from this series consume considerably less valuable energy. Overall, the extraneous operating costs, which comprise installation, maintenance and repair costs, are exceptionally low. The innovative control and regulating system allows for both fast and convenient operation. This alleviates the regular maintenance and has a positive effect on the operating costs.

Field of application:

- Fully automatic water supply and pressure boosting in residential, commercial and public buildings, hotels, hospitals, department stores and for industrial systems.
- Pumping of drinking water, process water, cooling water, fire water (apart from fire-extinguishing systems in accordance with DIN 14462 and with the approval of the local fire safety authorities) or other types of industrial water that do not attack the materials either chemically or mechanically and do not contain abrasive or long-fibre constituents.

Advantages for our customers at a glance:

- Sturdy system with Helix EXCEL stainless steel high-pressure circulation pumps with integrated frequency converter from 25 Hz to a maximum 60 Hz
- High-efficiency EC motor (energy efficiency class IE5 acc. to IEC 60034-30-2)
- Pressure-loss optimised with highly-efficient pump hydraulics
- Integrated dry-running detection with automatic deactivation via the motor control electronics
- Maximum degree of control using the SCe control device with LC display, simple navigation and configuration using rotary knob





Wilo-SiBoost Smart 1 Helix VE



High-efficiency connection-ready water-supply unit (non self-priming) with one vertically arranged stainless steel high-pressure multi-stage centrifugal pump in glanded version of the Helix VE series.

- Heavy-duty system with Helix VE series stainless-steel high-pressure multistage centrifugal pumps and air-cooled integrated frequency converter
- High-efficiency pump hydraulics
- Superproportionally large frequency converter control range from 25 Hz up to a maximum of 60 Hz (version dependent)
- Integrated full motor protection via PTC



Wilo-SiBoost Smart (FC) Helix V



Water supply/pressure boosting

- Heavy-duty system in accordance with DIN 1988 (EN 806)
- 2 to 4 vertical Helix V series stainless steel high-pressure multistage centrifugal pumps switched in parallel
- High-efficiency pump hydraulics
- Pressure-loss optimised entire system
- Control device SC, communication-capable for the monitoring of the system, LC display, simple navigation and adjustment via rotary knob without or with frequency converter for stepless control of the base-load pump

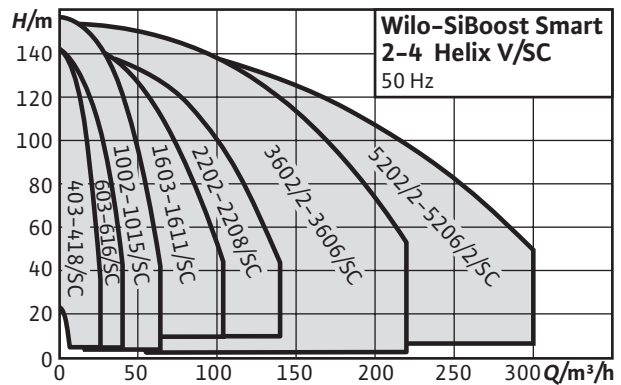
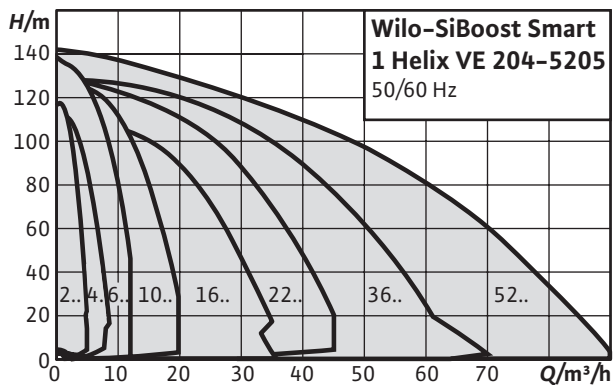



Wilo-Comfort-Vario COR-1 MVIE.../VR



Water supply/pressure boosting

- Sturdy system due to MVIE series stainless-steel high-pressure centrifugal pumps with air-cooled integrated frequency converter
- Frequency converter with superproportionally large control range
- Integrated full motor protection via PTC
- Integrated dry-running detection with automatic cut-out in event of low water via performance characteristics of the motor control electronics

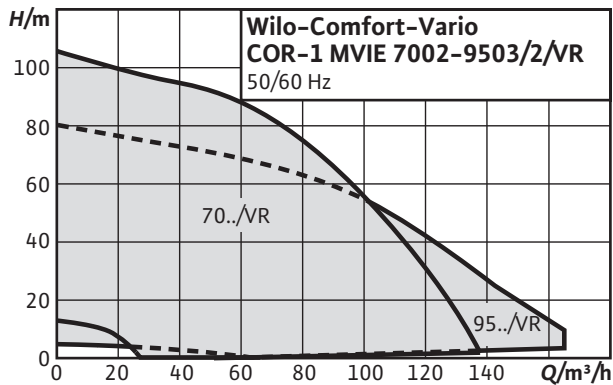

Wilo-Comfort-N-Vario COR-1 MWISE...-GE



Water supply/pressure boosting

- Heavy-duty system due to stainless steel high-pressure multi-stage centrifugal pumps of the Helix V series
- High-efficiency pump hydraulics
- Easily adjustable and operationally reliable due to the CE+ switchgear used

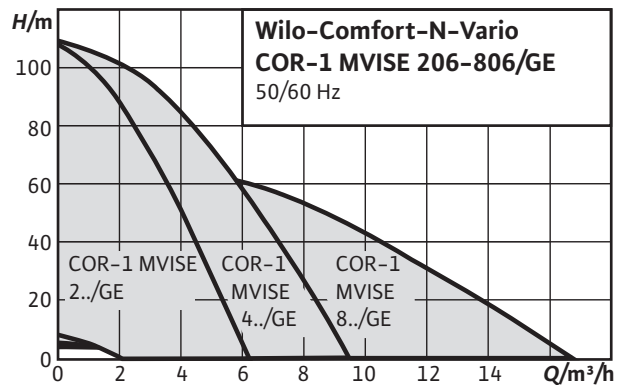



Wilo-Comfort-Vario COR-1 MHIE...-GE



Water supply/pressure boosting

- Sturdy system due to MHIE series stainless steel high-pressure multistage centrifugal pumps with air-cooled integrated frequency converter
- Frequency converter with superproportionally large control range
- Integrated full motor protection via PTC
- Integrated dry-running detection with automatic cut-out in event of low water via performance characteristics of the motor control electronics

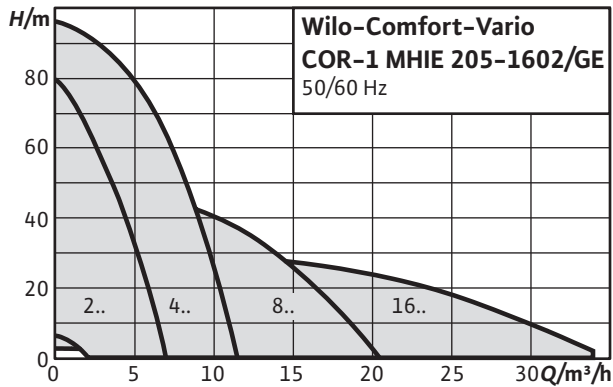

Wilo-Economy CO-1 Helix V.../CE+



Water supply/pressure boosting

- Sturdy system due to stainless steel high-pressure multistage centrifugal pumps of the MVI series
- Wide hydraulic range through the use of all pumps in the MVI series
- Easily adjustable and operationally reliable due to the ER-1 control unit used

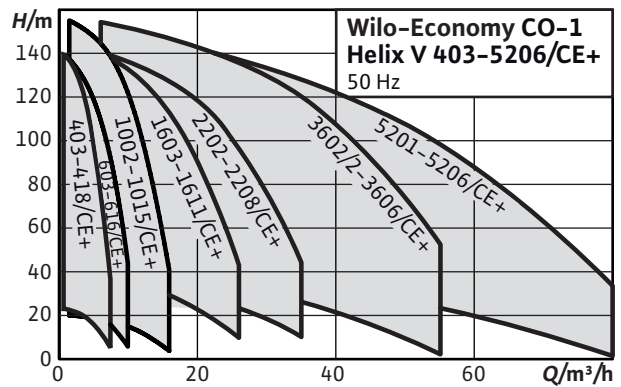



Wilo-Economy CO/T-1 Helix V



Water supply/pressure boosting

- Compact system, ready for connection, for all applications that require system separation
- Heavy-duty system due to stainless steel high-pressure multistage centrifugal pumps of the Helix V series
- Easily adjustable and operationally reliable due to the CE control device used

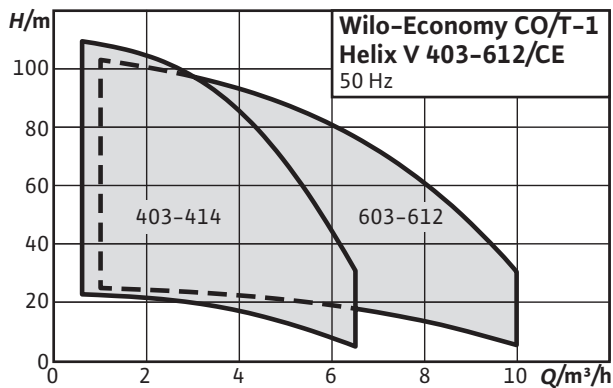

Wilo-Economy CO-1 MVI.../ER



Water supply/pressure boosting

- Sturdy system with to Helix VE series stainless-steel high-pressure multistage centrifugal pumps with integrated frequency converter
- Over-proportionally wide control range from 25 Hz up to a maximum of 60 Hz
- Entire system is pressure-loss optimised
- Integrated dry-running detection with automatic deactivation via the motor control electronics
- Maximum degree of control using the Sce control device with LC display, simple navigation and configuration using rotary knob

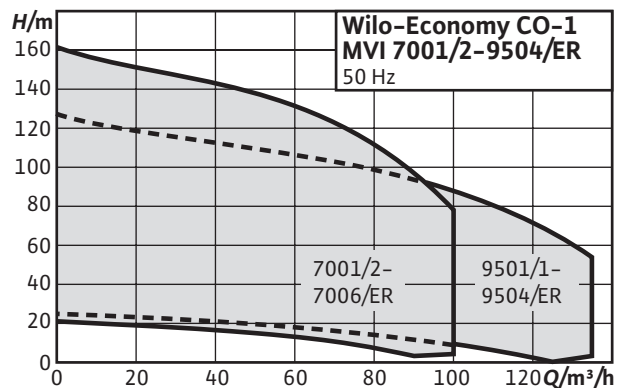



Wilo-Economy CO-1 MVIS.../ER



Water supply/pressure boosting

- Virtually noiseless system due to a glandless stainless-steel high-pressure multistage centrifugal pump
- Up to 20 dB[A] quieter than conventional systems with comparable hydraulic output
- Operationally reliable due to combination of MVIS pump series with ER-1 switchgear

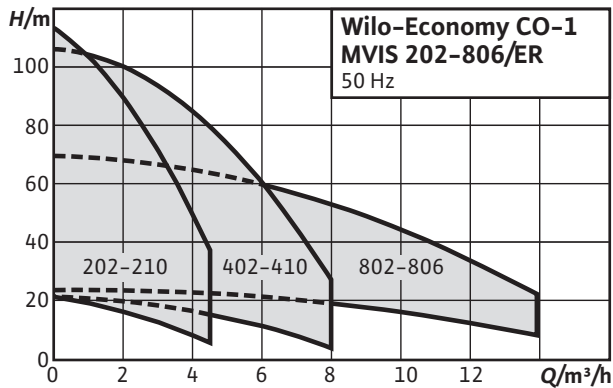

Wilo-SiBoost Smart Helix VE



Water supply/pressure boosting

- Sturdy system due to MVIE series stainless steel high-pressure multistage centrifugal pumps with air-cooled integrated frequency converters
- Superproportionally large control range
- Integrated dry-running detection with automatic cut-out in event of low water via performance characteristics of the motor control electronics

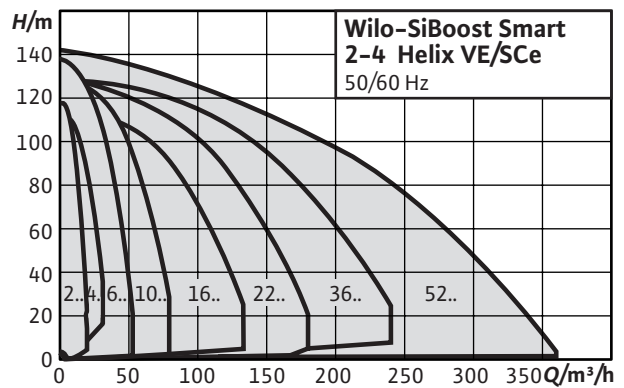



Wilo-Comfort COR Helix VE.../CCe



Water supply/pressure boosting

- Sturdy system with Helix VE stainless steel high-pressure circulation pumps with integrated frequency converter that can be controlled from 25 Hz to 60 Hz
- High-efficiency pump hydraulics
- Entire system is pressure-loss optimised
- Integrated dry-running detection with automatic deactivation via the motor control electronics
- Maximum degree of control using the CCe control device with additional functions, micro-computer control and touch display

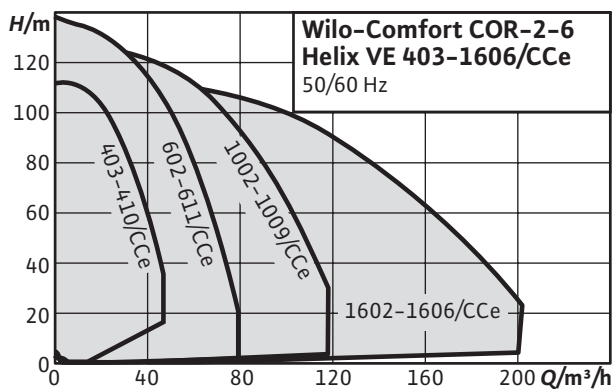

Wilo-Comfort-Vario COR MVIE.../VR



Water supply/pressure boosting

- Compact system with outstanding price/performance ratio due to MHIE series stainless steel high-pressure multistage centrifugal pumps with integrated air-cooled frequency converters
- Superproportionally large control range
- Integrated full motor protection with thermistor sensor (PTC)
- Integrated dry-running detection with automatic deactivation in the event of low water via the motor control electronics

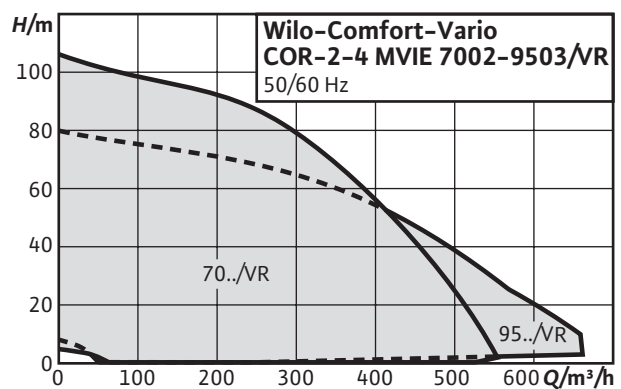



Wilo-Comfort-N-Vario COR MWISE.../VR



Water supply/pressure boosting

- System is virtually noise-free due to 2-4 parallel-switched, glandless stainless steel high-pressure multistage centrifugal pumps with integrated, water-cooled frequency converter
- Up to 20 dB[A] quieter than conventional systems with comparable hydraulic output
- Control range of frequency converters from 20 to 50 Hz
- Operationally reliable through MWISE pumps with integrated dry-running detection and automatic deactivation

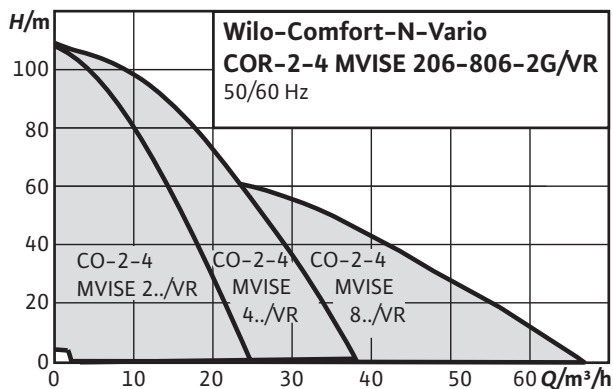

Wilo-Comfort-Vario COR MHIE.../VR



Water supply/pressure boosting

- Heavy-duty system in accordance with DIN 1988 (EN 806)
- High-efficiency pump hydraulics
- Pressure-loss optimised entire system
- 2 to 6 vertical Helix V series stainless steel high-pressure multistage centrifugal pumps switched in parallel
- Comfort CC control / regulation unit with extended functions, microcomputer and touchscreen, with or without frequency converter for infinitely variable control of the base-load pump

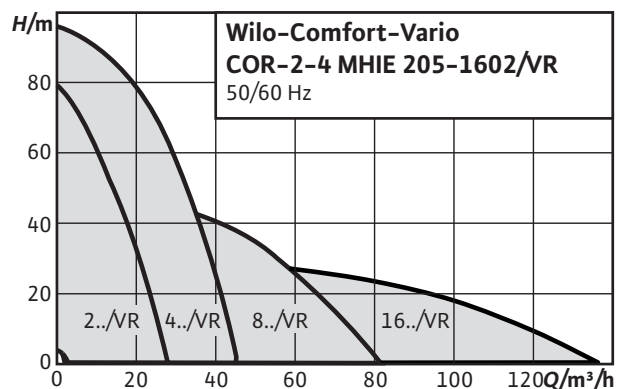



Wilo-Comfort CO-/COR-Helix V.../CC



Water supply/pressure boosting

- Heavy-duty system in accordance with DIN 1988 (EN 806)
- High-efficiency pump hydraulics
- Pressure-loss optimised entire system
- 2 to 6 vertical Helix V series stainless steel high-pressure multistage centrifugal pumps switched in parallel
- Comfort CC control /regulation unit with extended functions, microcomputer and touchscreen, with or without frequency converter for infinitely variable control of the base-load pump

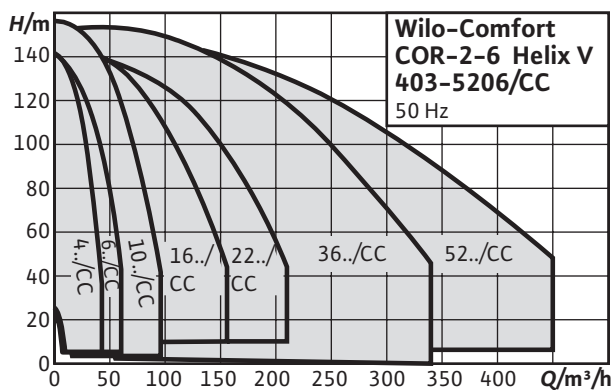

Wilo-Comfort-N CO-/COR-MVIS.../CC



Water supply/pressure boosting

- Easy-to-use system in accordance with all requirements of DIN 1988
- 2 - 6 vertical MVIS series full stainless steel high-pressure multistage centrifugal pumps switched in parallel
- Virtually noiseless system thanks to glandless stainless steel high-pressure centrifugal pump of the MVIS series
- Up to 20 dB[A] quieter than conventional systems with comparable hydraulic output

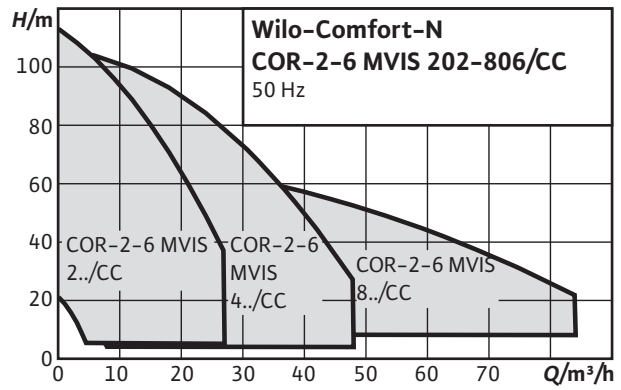



Wilco-Economy CO-MHI.../ER



Water supply/pressure boosting

- 2-4 pumps per system
- Components that come in contact with fluid are corrosion-resistant
- Galvanized base frame with height-adjustable vibration damper for insulation against structure-borne noise
- Pipework made of 1.4571 stainless steel
- Gear-operated shut-off ball cock/annular shut-off valve on every pump, on the suction and pressure side
- Non-return valve, pressure side
- Diaphragm pressure vessel 8 l, PN16, pressure side
- Pressure sensor, on the discharge side
- Optional pressure gauge (suction side)
- Pressure gauge (discharge side)
- Optional low-water cut-out switchgear

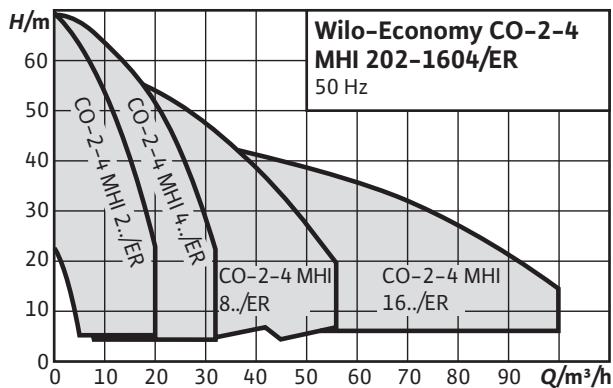

Wilco-FLA-1



Fire fighting

- Sturdy system with one Helix FIRST V or MVI stainless steel high-pressure multistage centrifugal pump, in accordance with DIN 1988 and DIN 14462
- Absolute operational reliability for 2-pump systems with 100 % redundancy
- Easy adjustment and operational reliability due to the FLA control unit
- Pre-set throttle valve on the pressure side of the pump to protect the pump at low volume flows

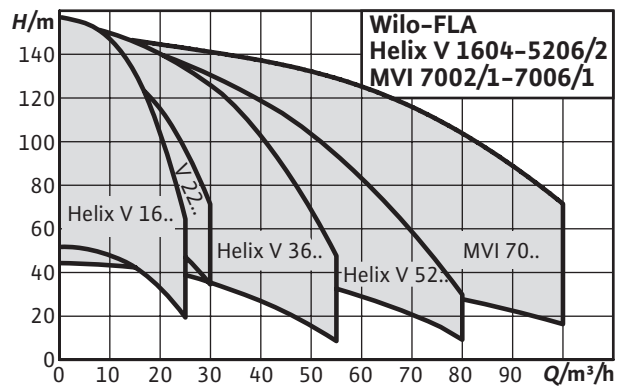



Wilo-FLA-2



Fire fighting

- 2-4 pumps per system
- Components that come in contact with fluid are corrosion-resistant
- Galvanized base frame with height-adjustable vibration damper for insulation against structure-borne noise
- Pipework made of 1.4571 stainless steel
- Gear-operated shut-off ball cock/annular shut-off valve on every pump, on the suction and pressure side
- Non-return valve, pressure side
- Diaphragm pressure vessel 8 l, PN16, pressure side
- Pressure sensor, on the discharge side
- Optional pressure gauge (suction side)
- Pressure gauge (discharge side)
- Optional low-water cut-out switchgear

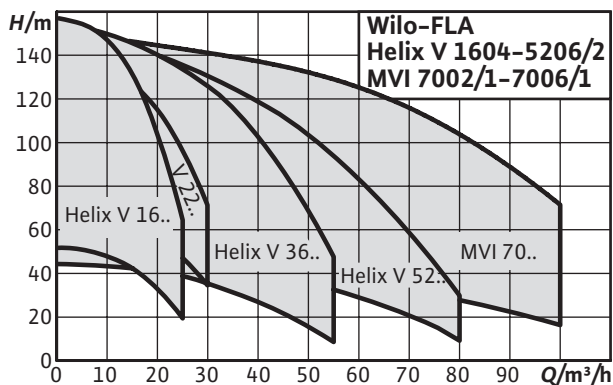

Wilo-FLA Compact-1 Helix V



Fire fighting

- Compact system with one Helix FIRST V series stainless steel high-pressure multistage centrifugal pump, in accordance with DIN 1988 and DIN 14462 (redundancy for 2-pump systems)
- Complete system which is supplied with a round tank (approved for drinking water) connected directly to the suction connection of the pump
- Hydraulic power within the series of up to 18 m³/h for 100 m delivery head
- Easily adjustable and operationally reliable due to the FLA operating unit (TÜV tested)
- Preconfigured bypass flow, for pump protection with low flow

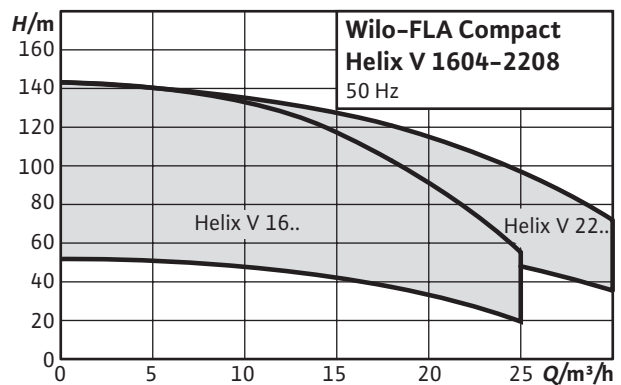

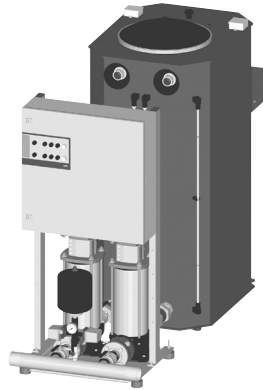

Wilo-FLA Compact-2 Helix V



Fire fighting

- Virtually noiseless system due to glandless stainless steel high-pressure multistage centrifugal pumps with integrated frequency converter
- Up to 20 dB[A] quieter than conventional systems with comparable hydraulic output
- Easily adjustable and operationally reliable due to the MVICE pump series used with integrated dry-running detection and automatic cut-out in event of low water

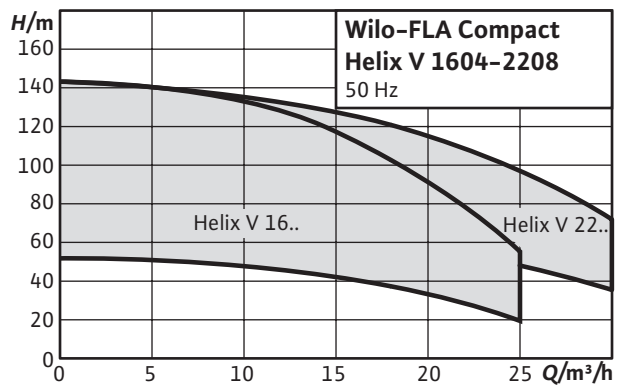



Wilco-Helix EXCEL



Water supply/pressure boosting

- Highly efficient EC motor of energy efficiency class IE5 in accordance with IEC 60034-30-2
- Integrated electronic control “High-Efficiency Drive”
- Simple operation thanks to tried-and-tested Green Button Technology and a clearly arranged display
- User-friendly “X-Seal” cartridge mechanical seal and spacer coupling (from 5.5 kW) for fast and easy maintenance
- Flexible integration into building automation
- Drinking water approval for pumps with parts that come in contact with the fluid made of stainless steel (EPDM version)

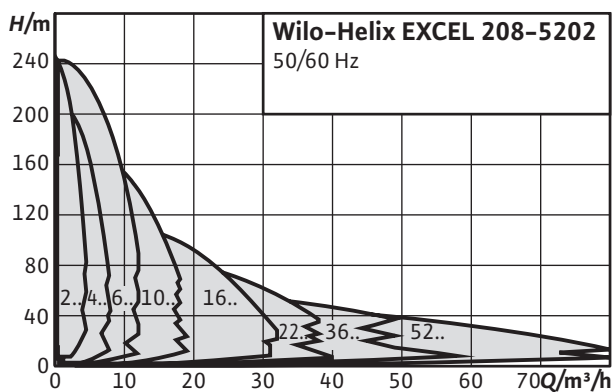

Wilco-Helix VE



Water supply/pressure boosting

- Multistage, speed-configurable stainless steel high-efficiency pump with 2D/3D hydraulics and standard motor
- Optimised design for easy operation, transportation and installation with handles, lantern adjustment and rotatable free flanges
- User-friendly display with Green Button Technology and full text menu
- IF plug-in module for quick communication with the BMS
- Quick maintenance due to innovative cartridge mechanical seal and spacers
- Lower life cycle costs due to new Helix design

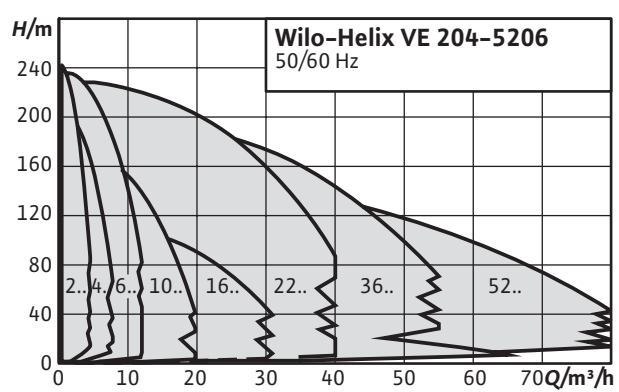



Wilo-Helix V



Water supply/pressure boosting

- Efficiency-optimised, laser-welded 2D/3D hydraulics, flow and degassing optimised
- Corrosion-resistant impellers, guide vanes and stage housings
- Flow and NPSH-optimised pump housing
- Maintenance-friendly design with particularly robust coupling guard
- Drinking water approval for pumps with parts that come in contact with the fluid made of stainless steel (EPDM version)

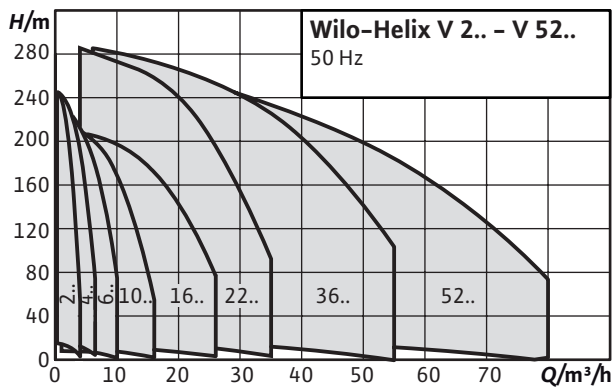

Wilo-Helix FIRST V



Water supply/pressure boosting, professional irrigation/agriculture

- Efficiency-optimised, laser-welded, optimised 2D/3D hydraulics
- Corrosion-resistant impellers, guide vanes and stage housings
- Flow and degassing-optimised hydraulic parts
- Reinforced pump housing, flow and NPSH optimised
- Space-saving and easy maintenance thanks to compact design
- Particularly sturdy coupling guard

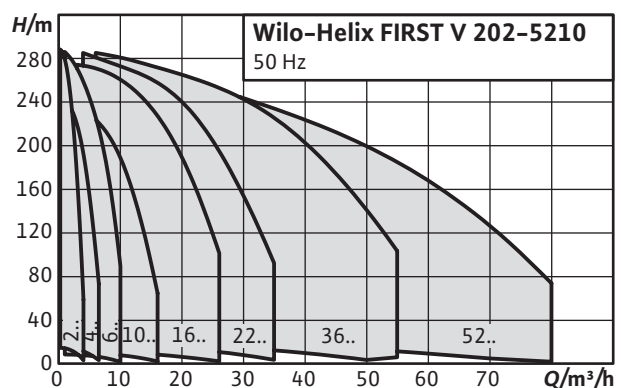



Wilometer MVIE



Water supply/pressure boosting, professional irrigation/
agriculture

- Easy commissioning
- Integrated frequency converter with large control range
- Full motor protection

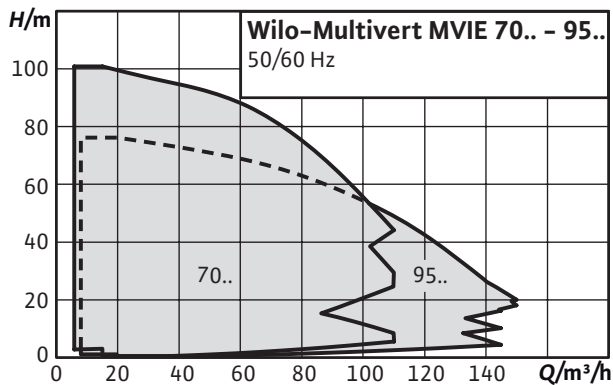

Wilometer MVI



Water supply/pressure boosting, professional irrigation/
agriculture

- Corrosion-resistant impellers, diffusers and stage housings
- Drinking water approval for all components that come in contact with the fluid (EPDM version)

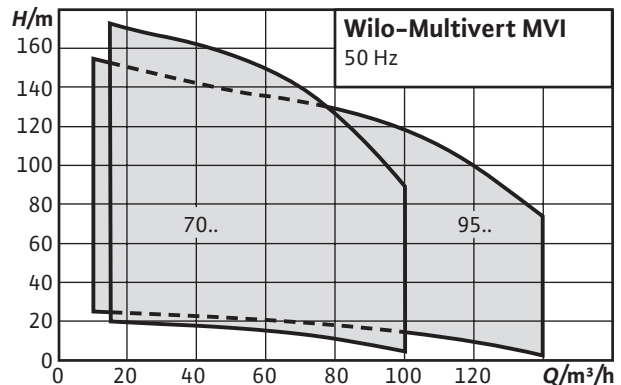



Wilo-Multivert MWISE



Water supply/pressure boosting

- Glandless pump technology
- Virtually noiseless operation (up to 20 dB [A] quieter than conventional pumps)
- Space-saving, compact design
- Virtually maintenance free thanks to a design which does not feature any mechanical seals
- Drinking water approval for all components that come in contact with the fluid (EPDM version)

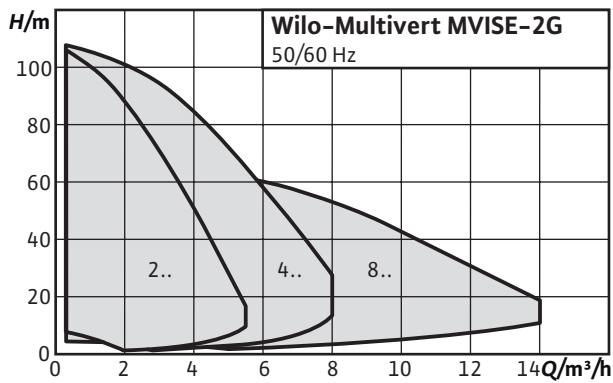

Wilo-Multivert MVIS



Water supply/pressure boosting

- Glandless pump technology
- Virtually noiseless operation (up to 20 dB [A] quieter than conventional pumps)
- Space-saving, compact design
- Virtually maintenance free thanks to a design which does not feature any mechanical seals
- Drinking water approval for all components that come in contact with the fluid (EPDM version)

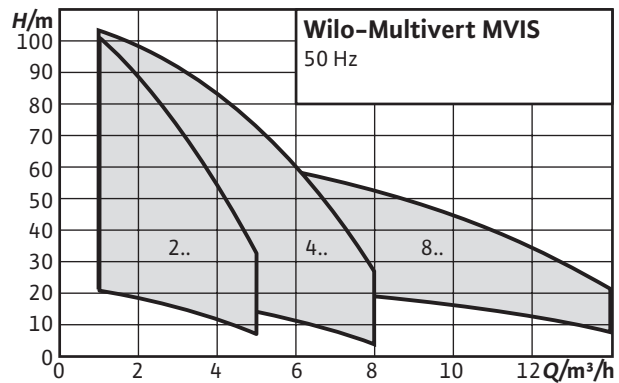



Wilco-Economy MHE



Water supply/pressure boosting

- Easy operation and compact design
- All parts in contact with fluid are made of stainless steel
- IEC three-phase motor (level IE2) with integrated frequency converter (frequency converter for 3~motors have optional interfaces for bus communication using plug-in IF-Modules)
- Full motor protection
- Drinking water approval (ACS, KTW, WRAS) for all components in contact with the fluid (EPDM version)

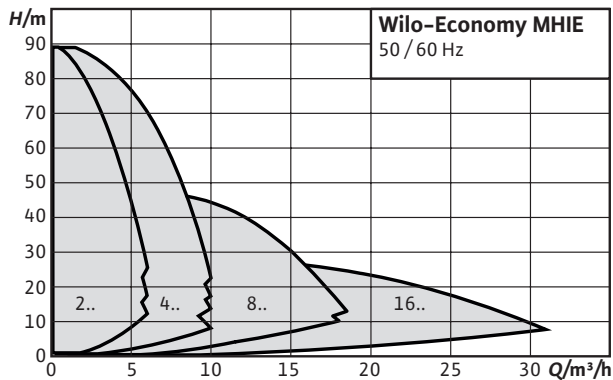

Wilco-Economy MHI



Water supply/pressure boosting

- IE3 IEC three-phase AC motor (≥ 0.75 kW)
- All parts that come in contact with the fluid are made of stainless steel 1.4301 (AISI 304) or 1.4404 (AISI 316L)
- Space-saving, compact design
- Drinking water approval (ACS, KTW, WRAS) for all components in contact with the fluid (EPDM version)

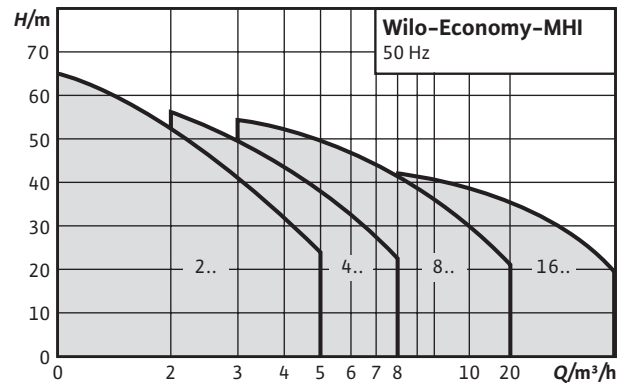



Wilo-Economy MHIL



Water supply/pressure boosting

- IE3 IEC three-phase AC motor (≥ 0.75 kW)
- Impellers and stage housing made of stainless steel
- Pump housing made of EN-GJL-250 cast iron, KTL coating
- Single-phase and three-phase versions available

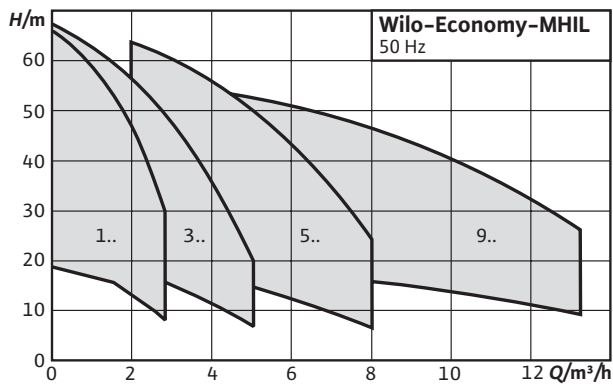

Wilo-Multivert MVIL



Water supply/pressure boosting

- Space-saving, compact block design

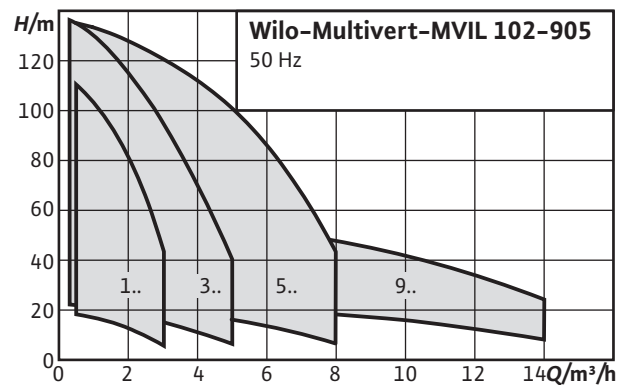

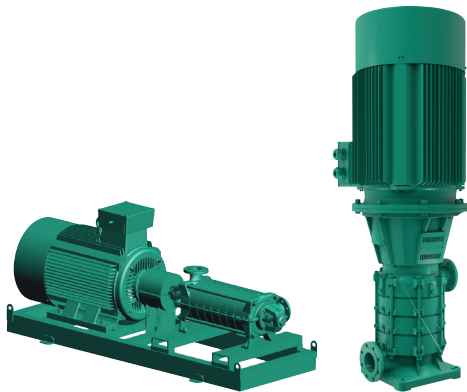

Wilo-Zeox FIRST



Rainwater utilisation, water supply/pressure boosting, raw water intake

- Extremely efficient hydraulics and highly-efficient IE3 motor with standard-mounted PTC sensor
- Pump set standard mounted with rigid coupling between motor and hydraulics and with mechanical seal
- Standard-mounted bypass flushing device guarantees a long service life for the mechanical seal
- Clever flange positioning and stuffing box gland upon request
- Bronze impellers upon request for high reliability

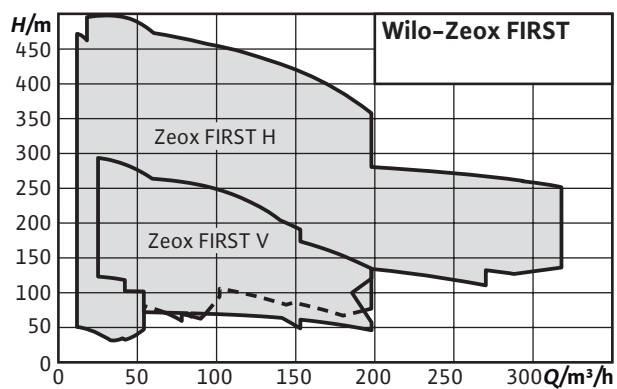



Wilo-Stratos GIGA



Heating, air conditioning, cooling, industrial process

- Innovative high-efficiency pump for maximum overall efficiency
- High-efficiency EC motor with efficiency class IE5 according to IEC 60034-30-2
- Optional interfaces for bus communication using plug-in IF-Modules

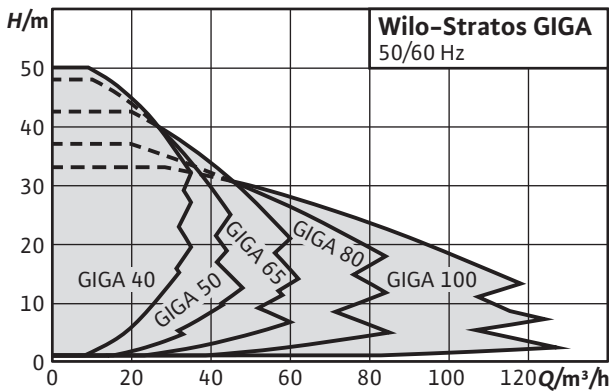

Wilo-VeroLine-IP-E



Heating, air conditioning, cooling, industrial process

- Energy savings due to integrated electronic power adjustment
- Optional interfaces for bus communication using plug-in IF-Modules
- Simple operation with Green Button Technology and display
- Integrated dual pump management
- Integrated full motor protection (PTC thermistor sensor) with trip electronics

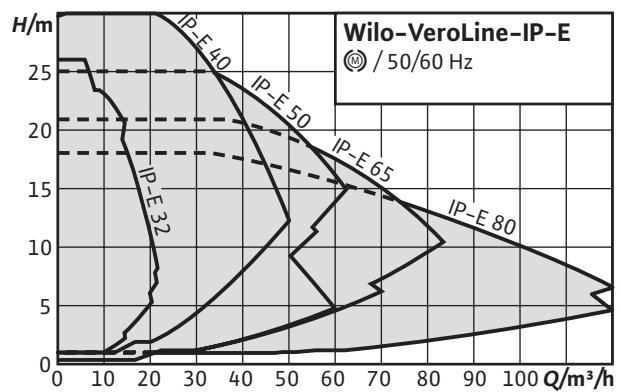



Wilco-CronoLine-IL-E



Heating, air conditioning, cooling, industrial process

- Energy savings due to integrated electronic power adjustment
- Optional interfaces for bus communication using plug-in IF-Modules
- Simple operation with Green Button Technology and display
- Integrated dual pump management
- Integrated full motor protection (PTC thermistor sensor) with trip electronics

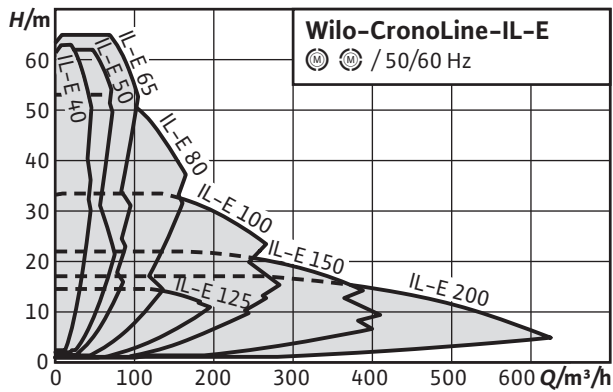

Wilco-VeroLine-IPL



Heating, air conditioning, cooling, industrial process

- High standard of corrosion protection thanks to cathaphoretic coating
- Standard condensate drainage holes in the motor housings and lanterns
- Series design: motor with one-piece shaft
- Version N: Standard motor V1 with stainless steel plug shaft
- Bidirectional, force-flushed mechanical seal

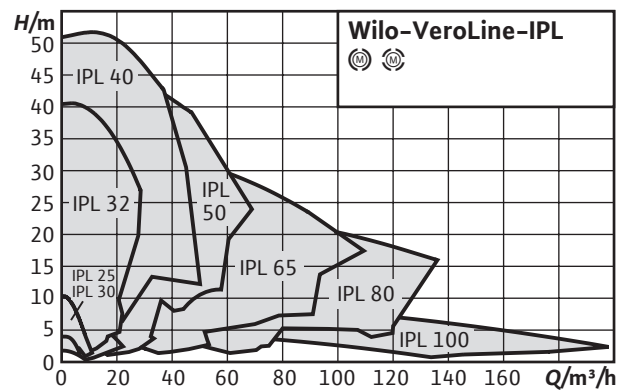



Wilo-CronoLine-IL



Heating, air conditioning, cooling, industrial process

- Reduced life cycle costs thanks to optimized efficiency
- Standard condensate drainage holes in the motor housings
- Can be used flexibly in air-conditioning and cooling systems, with application benefits due to direct draining of condensate via optimised lantern design (patented)
- High standard of corrosion protection thanks to cathaphoretic coating
- High worldwide availability of standard motors (according to Wilo specifications) and standard mechanical seals



Wilo-BAC



Heating, air conditioning, cooling, industrial process

- Reduced life-cycle costs through optimised efficiency levels
- Pump housing in plastic design
- Version with Victaulic or threaded connection (BAC 70/135... With Victaulic connection only)

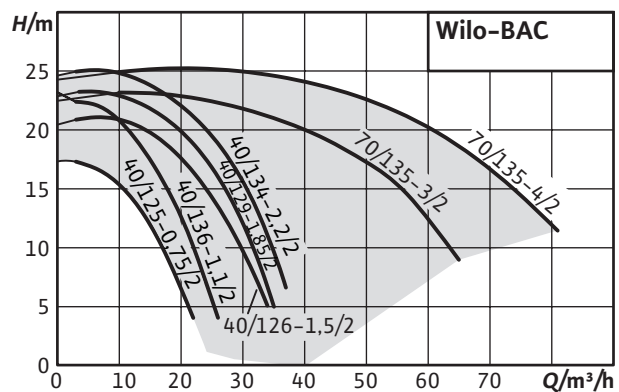
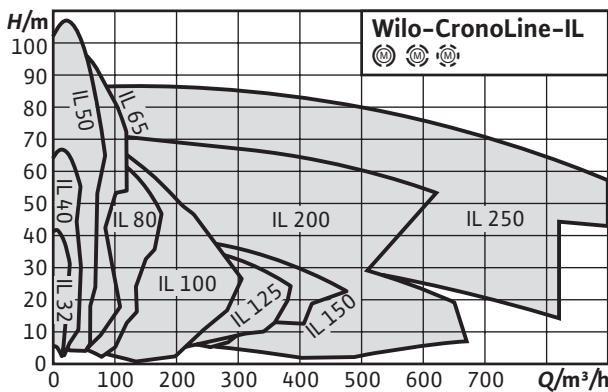

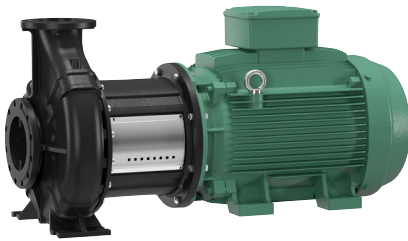

Wilo-CronoBloc-BL



Heating, air conditioning, cooling, industrial process

- Energy-saving thanks to state-of-the-art pump hydraulics and the use of IE3 motors
- Suitable for drinking water supply (ACS approved)
- Can be globally used in a wide variety of applications thanks to various impeller materials, several motor options as well as different mechanical seals
- Easy installation due to standard pump support feet and optional supporting blocks
- Easy maintenance and user-friendly design with “back pull-out” design and cartridge mechanical seal for large pump types

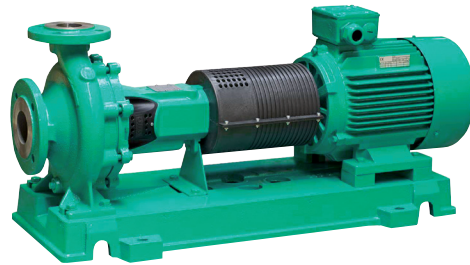
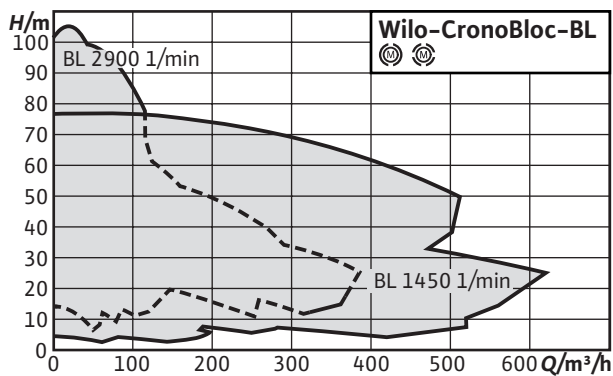

Wilo-CronoNorm-NL



Heating, air conditioning, cooling, water supply, industrial process

- Reduced life-cycle costs through optimised efficiency levels
- Bidirectional, force-flushed mechanical seal
- Low NPSH values, best cavitation properties
- Shaft coupling with or without spacer coupling

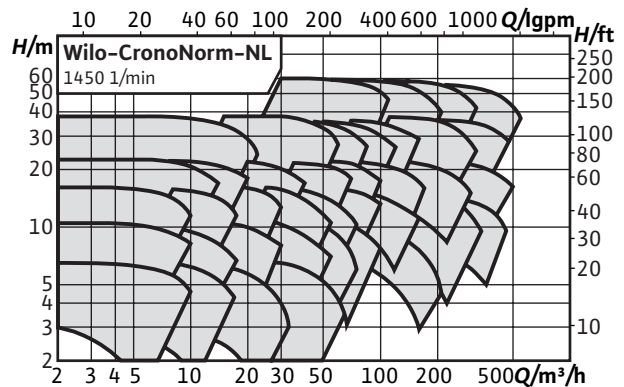

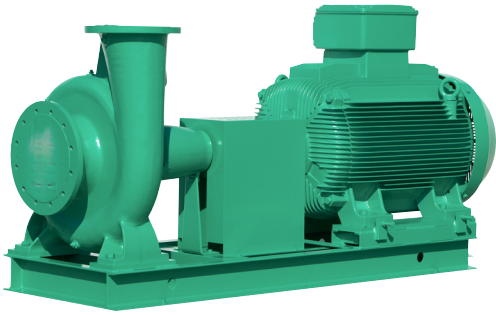

Wilo-VeroNorm NPG



Heating, air conditioning, cooling, industrial process

- Suitable for temperatures up to 140°C
- Back-pull-out version
- Extension of the DIN EN 733 product range

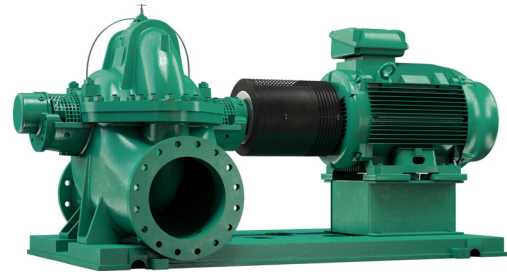

Wilo-SCP



Cooling, air conditioning, water distribution/boosting, industrial process

- Efficient hydraulics for high flow rates up to 17,000 m³/h
- Low NPSH thanks to double suction impeller
- High process reliability and easy maintenance without removing the pressure or suction lines
- Decreased noise level and reduced vibrations
- Options: energy efficient IE3-/IE4 motors, drinking water approval (KTW, ACS), innovative Ceram CT coating

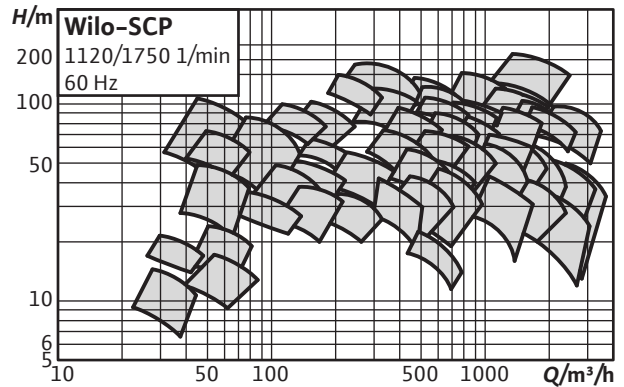
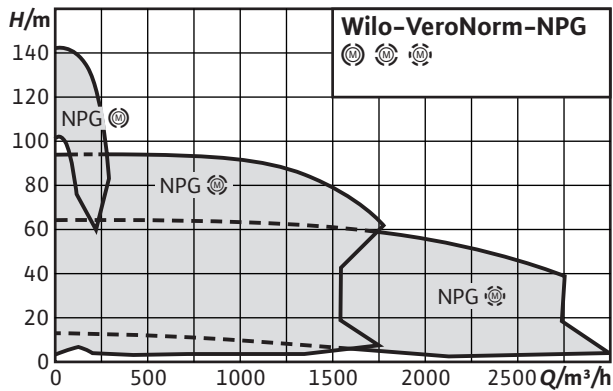





WASTEWATER COLLECTION AND TRANSPORT

INTELLIGENT SOLUTION FOR A SMART SEWAGE PUMPING STATION

Wilo-Rexa SOLID-Q with Nexos Intelligence



The new Wilo-Rexa SOLID-Q with Nexos Intelligence is a holistic and future-proof system solution for smart sewage pumping stations. It uses a unique, integrated intelligence to dynamically adapt to the changing demands of its environment and provide maximum system efficiency and connectivity. The Wilo-Rexa SOLID-Q with Nexos Intelligence thus considerably increases operational reliability, economy and convenience for our customers.

High operational reliability is provided by Wilo-SOLID-Q impellers, featuring self-cleaning action and the integrated smart Nexos electronic control system, which detects and independently rectifies clogging without an operator having to intervene. This significantly reduces the rate of pump downtime. In addition, the increased automatic interventions allow operators to identify emerging faults at an early stage and service a pump in a targeted manner. This in turn helps to reduce operating costs. Fewer service call-outs are needed, and costly maintenance work performed at night or on weekends is avoided.

Customer benefits at a glance:

- Maximum operational reliability and reduced service costs, especially for pumping untreated sewage, thanks to self-cleaning properties
- Lower energy costs thanks to high hydraulic efficiency and up to IE5 motor technology in wet and dry well installation (based on IEC 60034-30-2)
- Corrosion protection provided by an optional Ceram coating for a long service life in aggressive media
- An integrated digital data interface (DDI) with integrated vibration monitoring, data logger, web server and digital rating plate for convenient monitoring and system integration
- Nexos Intelligence is integrated for pump and system optimisation:
 - Reduced downtime and service call-outs thanks to automatic detection and elimination of clogging
 - Lower energy costs owing to automated control for the optimum operating mode of a specific system
 - Control and networking with the station network via a web server and an Ethernet interface with standard network protocols
 - Increased operational reliability in the event of a fault thanks to the redundancy design of the integrated pump control
 - System solution with application-specific adaptable functions and digital interfaces



Smart solution:
Sewage pump
with built-in
Nexos Intelligence



SMART NETWORKING FOR INCREASED RELIABILITY AND EFFICIENCY.

Pressure drainage system with Nexos Intelligence



For the first time ever, the pressure drainage system with Nexos Intelligence provides the opportunity for comprehensive system networking, monitoring and control. It is composed of various Wilo components: the Wilo-Port 800 pump chamber, the Wilo-Rexa CUT submersible sewage pump with macerator, the Wilo-EC Lift switchgear with radio antenna, a gateway and a new operating software. Individual pumping stations are interconnected by external switchgears with radio antennas and are digitally networked via central control software. The pressure drainage system with Nexos Intelligence controls the pumping stations and empties them according to individually developed algorithms, either in stages or at set intervals. At the end of the pressure drainage system, the Wilo-EMUport CORE serves as a collective pumping station and, as a solids separation system, also enhances operational reliability.

The intelligent solution ensures compliance with optimal flow rates in the collector pipelines and collective pumping stations while also minimising the risk of deposits and clogging. The pumps also benefit from this system as they operate at optimum levels. As a result, both cutting behaviour and energy consumption are improved, avoiding cavitation and volume flow becoming too low. This sustainably improves the operational reliability of the entire pressure drainage system. All status information is compiled on the central server so that the operator has a detailed view of the pressure drainage system on their computer at all times. Thanks to prompt and transparent error messages, the operator can also identify and resolve faults at an early stage, thereby preventing damage and system failures.

Customer benefits at a glance:

- Optimised flow rates in the collector pipelines ensure that the pressure drainage systems are energy efficient and run without clogging
- The pumps are economical to use as their duty points are optimised to ensure reliable operation with low rates of wear
- Reduced maintenance and repair costs for municipal sewage pipes
- Operating costs are reduced through early fault detection, targeted troubleshooting and detailed error messages sent via text message (SMS) or email
- Networked systems and digital data transfer make it easy for every pumping station to be accessed and managed online via a web interface

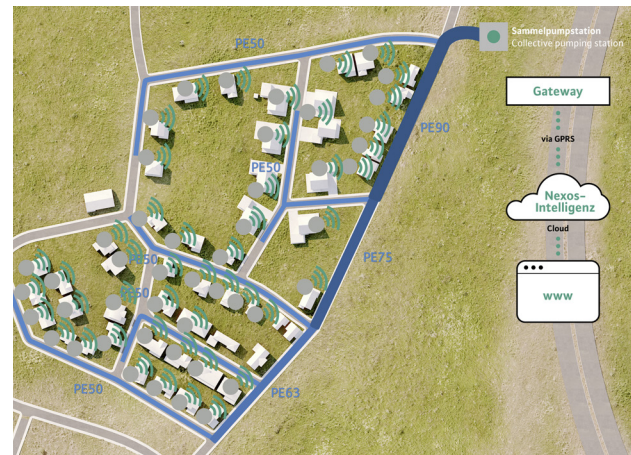

Wastewater collection and transport



Wilo-Drain MTC



Wastewater collection and transport, dewatering/flood control

- Long service life
- Heavy-duty design
- Slurping operation possible
- Suitable for continuous duty (S1)
- Ready-to-plug

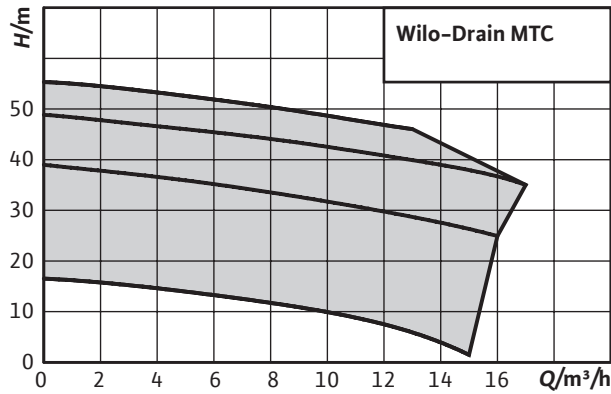

Wilo-Rexa CUT



Wastewater Collection and Transport

- High reliability through ATEX approval and longitudinally watertight cable inlet (CUT GE...)
- High operational reliability through spherically-formed macerator with pulling cut
- Long service life through a high-quality motor seal with two independent mechanical seals and optional pencil electrode for sealing chamber control



Smart solution:
This product is connectable to pressure drainage systems with Nexos Intelligence.

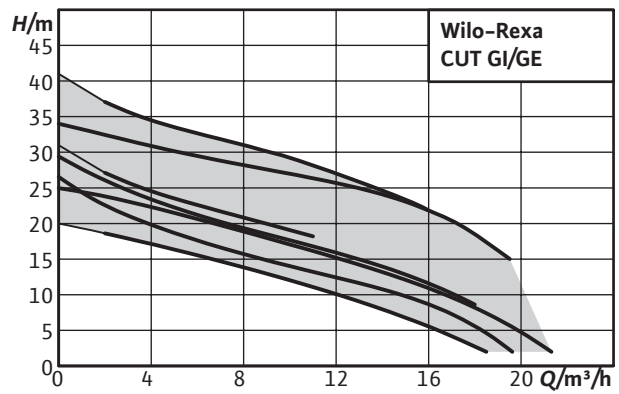



Wilo-Rexa UNI



Wastewater collection and transport, dewatering/flood control

- Long service life
- Heavy-duty design
- Slurping operation possible
- Suitable for continuous duty (S1)
- Ready-to-plug

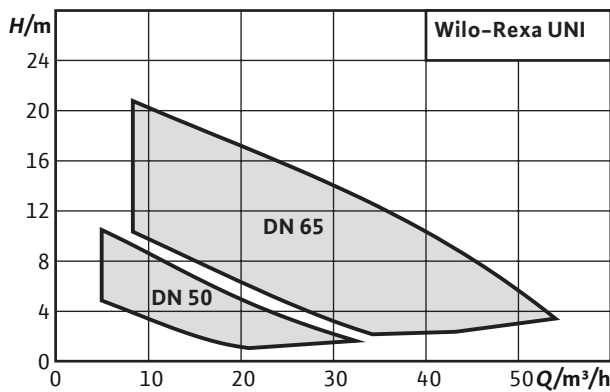

Wilo-Rexa FIT



Wastewater collection and transport, wastewater treatment, dewatering/flood control

- Ready to plug in and use
- Attached float switch (A-model) enables easy operation
- Safe vortex hydraulics with large, free ball passage to prevent clogging during operation
- Sealing chamber with optional external monitoring
- Low weight

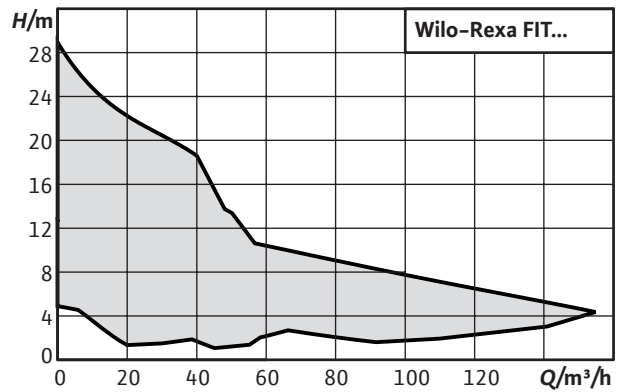



Wilo-Rexa PRO



Wastewater collection and transport, wastewater treatment, dewatering/flood control

- Long service life
- Heavy-duty design
- Slurping operation possible
- Suitable for continuous duty (S1)
- Ready-to-plug

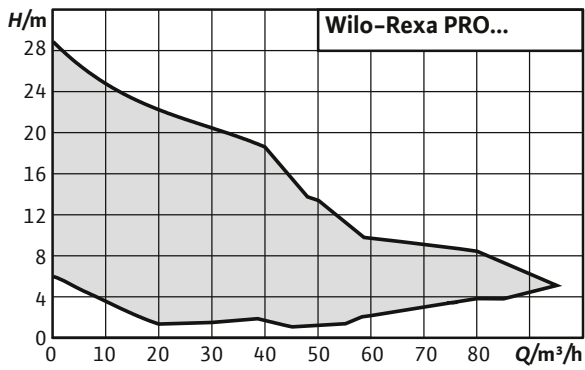

Wilo-Drain TP 80/TP 100



Wastewater collection and transport, dewatering/flood control, industrial process

- Self-cooling motor for use in wet and dry set-ups
- Corrosion-resistant stainless steel motor housing made of 1.4404
- Patented clogging-free hydraulics
- Longitudinally watertight cable inlet
- Low weight

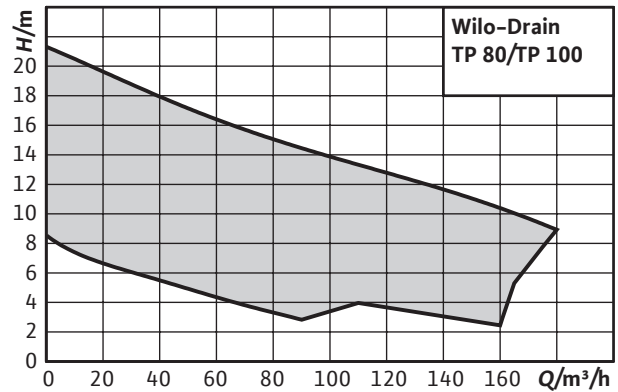



Wilo-EMU FA (standard pump)



Wastewater collection and transport, wastewater treatment, dewatering/flood control

- Long service life
- Heavy-duty design
- Slurping operation possible
- Suitable for continuous duty (S1)
- Ready-to-plug



Wilo-EMU FA 08...60 (configurable)



Wastewater collection and transport, wastewater treatment, dewatering/flood control

- Operationally reliable thanks to Vortex hydraulics and single-channel hydraulics with large, free ball passage
- Process reliability thanks to optional monitoring for the sealing chamber

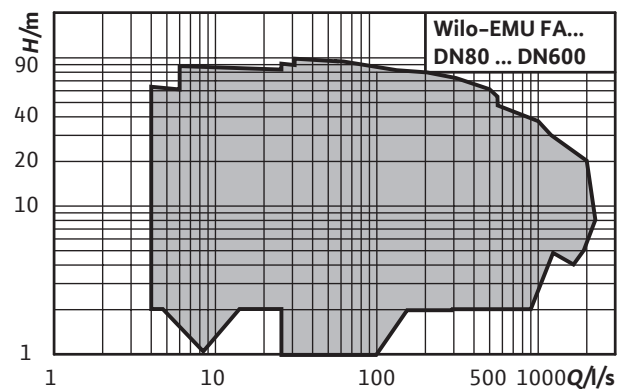
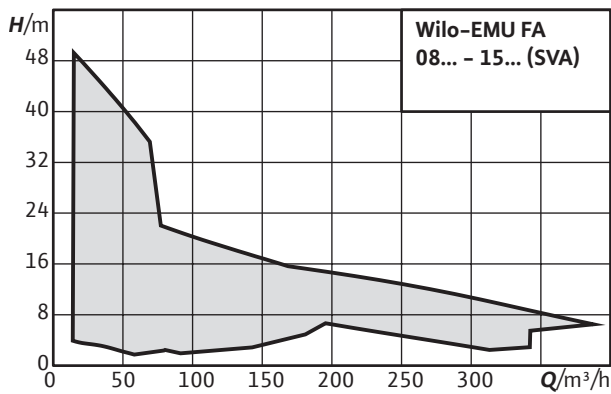



Wilo-EMU FA (solid)



Wastewater collection and transport, wastewater treatment, dewatering/flood control

SOLID T impeller

- Patented SOLID hydraulics for reduction of clogging susceptibility, suitable for untreated sewage
- High hydraulic efficiency
- Reduction of vibrations through a flow-optimised impeller geometry for secure operation and long service lives
- Energy-efficient IE3 motor technology available as an option
- Ceram coating and special material for protection against abrasion and corrosion

SOLID G impeller

- SOLID hydraulics for reduction of clogging susceptibility, suitable for untreated sewage

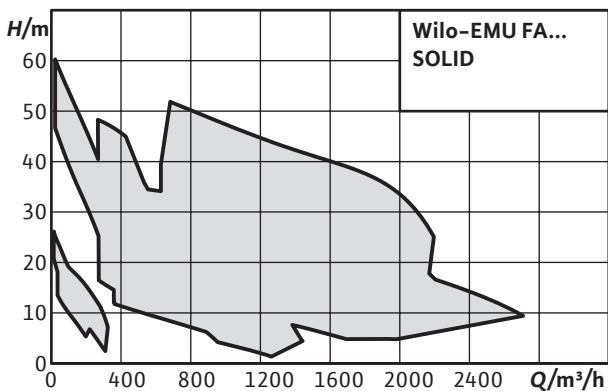

Smart solution:
Sewage pump with built-in Nexos Intelligence.

Wilo-Rexa SOLID

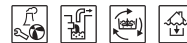

Submersible sewage pump with and without active cooling system for pumping untreated sewage for continuous duty in the stationary and portable wet well installation, as well as for stationary dry well installation.

- Maximum operational reliability and reduced service costs, especially for pumping untreated sewage, thanks to self-cleaning properties
- Lower energy costs thanks to outstanding hydraulic efficiency and up to IE5 motor technology in wet and dry well installation (based on IEC 60034-30-2)
- Corrosion protection provided by an optional Ceram coating for a long service life in aggressive media
- An optional Digital Data Interface (DDI) with integrated vibration monitoring, data logger, web server and digital rating plate for convenient monitoring and system integration
- Integration of Nexos Intelligence

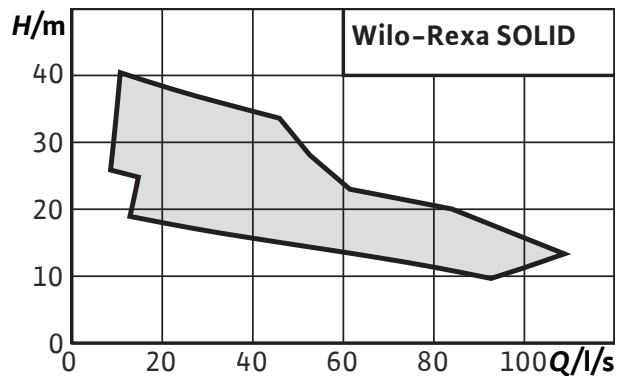



Wilo-RexaBloc RE



Wastewater collection and transport, wastewater treatment, dewatering/flood control

- High operational reliability due to shut bearing bracket design with oil-filled sealing chamber and additional leakage chamber.
- Optionally with two mechanical seals for increased operational reliability.
- Equipped with IE3 motors as standard. Optionally available with IE4 premium motors.
- Simple maintenance due to “back pullout” design. This means the motor and the impeller can be removed without needing to remove the hydraulics from the piping.

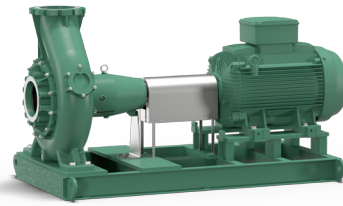
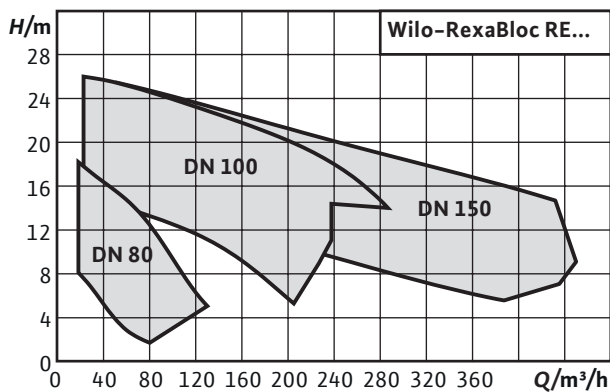

Wilo-RexaNorm RE



Sewage pump with standard motor, connected via coupling, fully mounted on baseplate, for stationary dry well installation

- Easy impeller replacement due to “back pull-out” design and spacer coupling as standard. This makes it possible to uninstall the impeller without dismantling the hydraulics from the pipeline and the motor from the baseplate.
- Shut “Back pull out” unit: Dismantling without draining the oil in the sealing chamber.

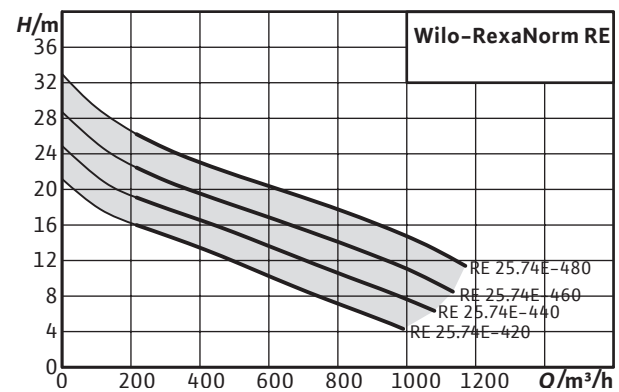

MAXIMUM OPERATIONAL RELIABILITY FOR CONTINUOUS CONSTRUCTION SITE DRAINAGE.

Wilo-Padus PRO



Wilo ensures enhanced efficacy and efficiency for construction site drainage. Our innovative solution combines the powerful, robust and energy-efficient Wilo-Padus PRO (equipped with an IE3 motor) with the convenience of the WiloCare service. The Wilo-Padus PRO is characterised by its high reliability for continuous duty in abrasive media. This is achieved through the use of wear-resistant material combinations, active cooling for continuous use – particularly in slurping operation – and an integrated protection function. The pump can be used in a wide variety of applications and put into operation quickly thanks to its low weight and flexible pressure connection. Quick access to the most important components also simplifies maintenance. For instance, the clearance between the impeller and baseplate can be manually adjusted to increase efficiency again.

In combination with our WiloCare service range, the transportable submersible drainage pump offers the highest possible level of cost security and operational reliability for economical and reliable continuous duty. WiloCare allows you to read out and analyse the pump's operating status via a module, which therefore ensures operational reliability. The service can be adapted to meet a customer's individual requirements with the Basic, Comfort and Premium packages. Our customers can rely on convenient services:

- Constant pump status monitoring
- Reliable operation and cost security
- Troubleshooting and operation optimisation

The customers are also spared time-consuming on-site inspections which require personnel to check the status of the pumps. The holistic service and the Wilo-Padus PRO – designed with digitalisation in mind – together allow customers to plan and optimise maintenance cycles for the pump in a targeted manner whilst profiting from an extended service life and sustainably efficient operation.

Customer benefits at a glance:

- High reliability in abrasive media due to rubber-coated hydraulics and an impeller made of duplex chrome steel
- Easy installation thanks to low weight and flexible pressure connection (vertical/horizontal)
- Active cooling for reliable continuous duty, particularly in slurping operation
- Easy maintenance thanks to quick access to the wear parts
- Equipped with energy-efficient IE3 motor technology as standard
- Highest operational reliability thanks to integrated protection function
- Optional additional integrated electronics monitoring and operating data storage available for maintenance diagnosis
- Optional WiloCare service with operating data analysis for optimal maintenance work scheduling
- Guaranteed operational reliability and cost security with the WiloCare service
- WiloCare can be adapted according to individual requirements with the "Basic", "Comfort" and "Premium" packages





Wilo-Drain VC



Water supply/pressure boosting, professional irrigation/ agriculture, dewatering/flood control

- For fluid temperatures up to 95 °C
- Long service life
- Easy operation due to the attached float switch
- Long standstill times possible
- Built-in motor protection by thermal relay

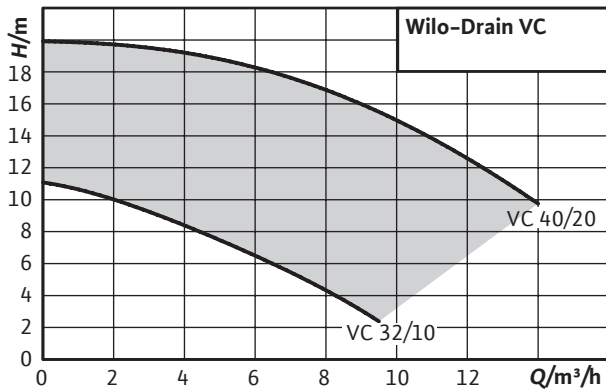

Wilo-Drain TMT



Dewatering/flood control, industrial process

- For fluid temperatures up to 95 °C
- Cable inlet (cast)
- Motor temperature monitoring

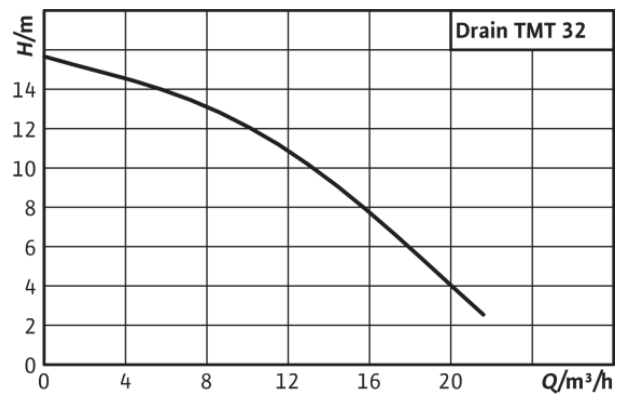



Wilo-Padus UNI



Wastewater collection and transport, dewatering/flood control

- Outstanding reliability, thanks to corrosion-free hydraulics for universal applications and various fluids
- Easy installation due to its low weight and threaded flange
- Quick maintenance facilitated by direct access to the pump housing
- Long maintenance intervals thanks to the double mechanical seal and large-volume sealing chamber

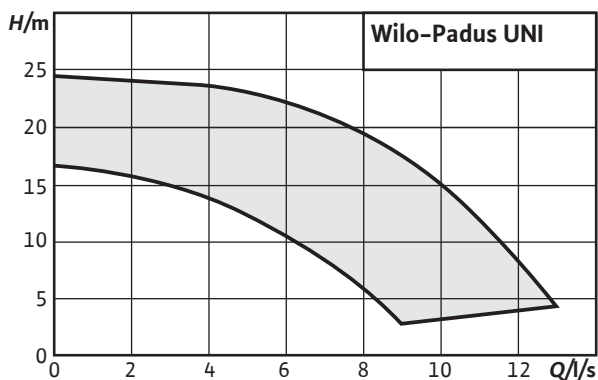

Wilo-Padus PRO



Submersible drainage pump

- High reliability in abrasive media thanks to rubber-coated hydraulics and impeller made of hardened chrome steel
- Easy installation thanks to low weight and flexible pressure connection (vertical/horizontal)
- Active cooling for reliable continuous duty, particularly in slurping operation
- Easy maintenance due to quick access to wearing parts
- Equipped with energy-efficient IE3 motor technology as standard
- Highest operational reliability thanks to integrated protection function

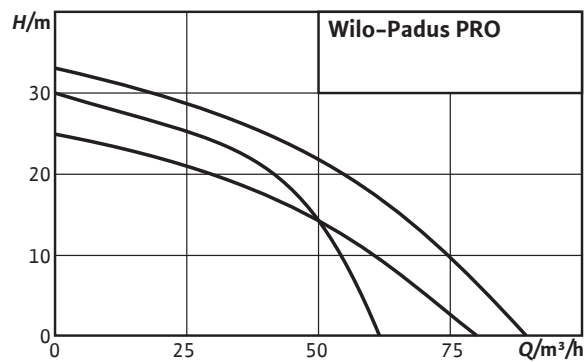



Wilo-EMU KS



Dewatering/flood control, industrial process

- Long service life
- Heavy-duty design
- Slurping operation possible
- Suitable for continuous duty (S1)
- Ready-to-plug

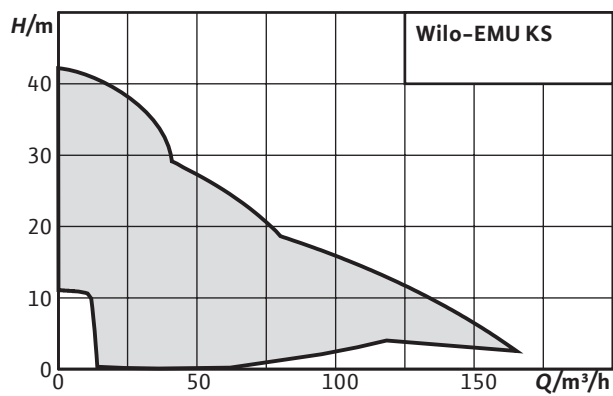



Wilo-DrainLift XL



Sewage lifting unit as double-pump system

- Flexible thanks to a height-adjustable and swivel-capable inlet connection
- Easy to use thanks to built-in switchgear
- Integrated non-return valve
- Operational reliability via high switching volumes and reliable level recording
- Suitable for continuous duty (S1) with the use of self-cooling motors

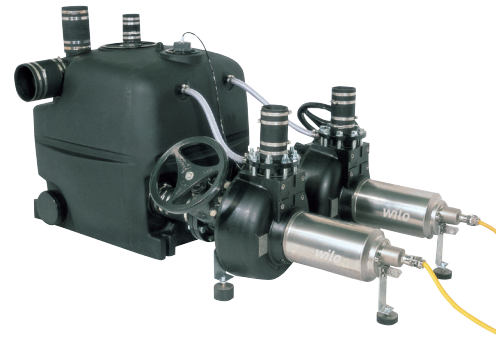
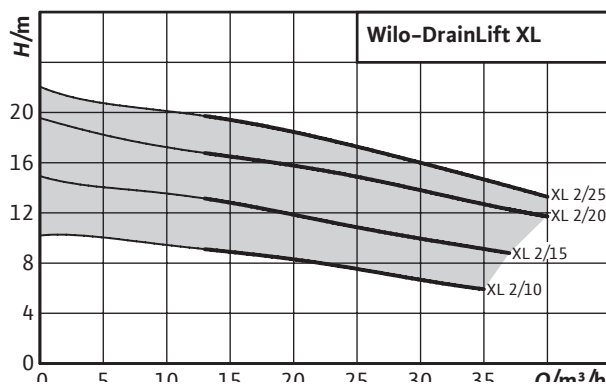

Wilo-DrainLift XXL



Sewage lifting unit as double-pump system with two separate, dry-mounted pumps

- Flexible use through the use of one or two tanks
- Optimal tank drainage due to deep extraction by suction
- Operational reliability via high performance range and reliable level recording
- Suitable for continuous duty (S1) with the use of self-cooling motors

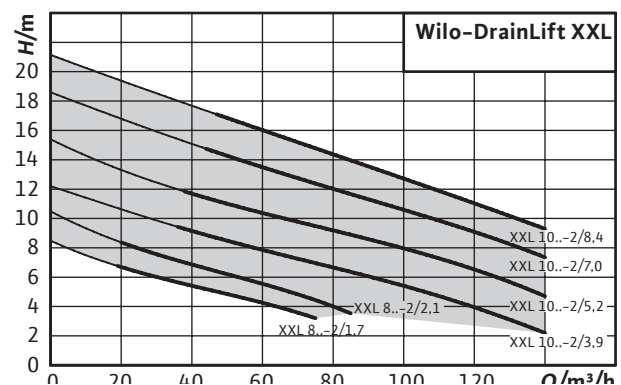



Wilo-EMUport CORE



Standard sewage lifting unit with solids separation system in accordance with DIN EN 12050-1 for installation in a building or in a pump chamber for outdoor installation.

- Maximum operational safety with separation of solids from the sewage: Large solids do not have to pass through the pump – no clogging
- Cost-effective thanks to retrofit system for simple renovation of old pumping stations
- Durable and corrosion-free due to the use of PE and PUR material
- Easy maintenance, even during operation – thanks to hygienic dry well installation and easy access from outside and individual blocking
- Future-proof even with increasing solid content in sewage
- Flexible installation in buildings or in chambers from 1,500 mm diameter



Wilo-EMUport FTS



Customizable sewage lifting unit with solids separation system for installation in a building or in a pump chamber for outdoor installation.

- Maximum operational safety with separation of solids from the sewage: Large solids do not have to pass through the pump – no clogging
- Cost-effective thanks to retrofit system for simple renovation of old pumping stations
- Durable and corrosion-free due to the use of PE-HD material
- Flexible scaling according to your requirements
- Easy maintenance thanks to hygienic dry well installation and easy access from outside
- Flexible installation in buildings or in chambers from 1,500mm diameter

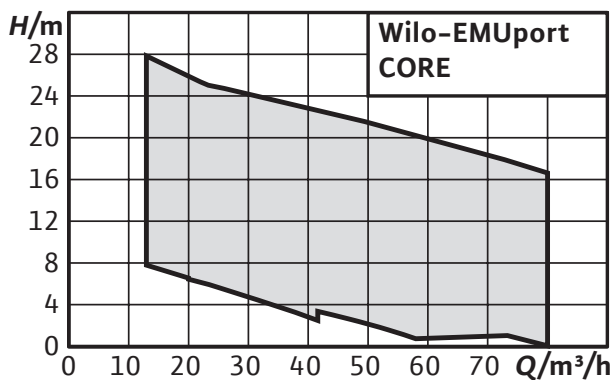



Wilo-Port 600



Wastewater Collection and Transport

- Universal use thanks to continuous pump chamber extension up to 2.75 m
- Anti-buoyant without weights for ground water levels up to the surface of the ground for maximum operational reliability
- covers up to load class D 400
- Easy maintenance thanks to surface coupling
- Long service life thanks to pump chamber body made of corrosion-free polyethylene



Wilo-Port 800



Wastewater Collection and Transport

- Universal use thanks to continuous pump chamber extension up to 2.75 m
- Anti-buoyant without weights for ground water levels up to the surface of the ground for maximum operational reliability
- covers up to load class D 400
- Easy maintenance thanks to surface coupling
- Long service life thanks to pump chamber body made of corrosion-free polyethylene



Smart solution:
 This product is connectable to pressure drainage systems with Nexos Intelligence.



Wilo-Drainlift WS 1100



Wastewater Collection and Transport

- Flexible installation
- Anti-buoyant
- High stability





WASTEWATER TREATMENT



INTELLIGENT SOLUTIONS FOR THE WASTEWATER TREATMENT CIRCUIT.

Wilo-Flumen EXCEL-TRE



Stormwater retention tanks. Fully drained with direct-drive submersible mixers.

Stormwater retention tanks ensure that the wastewater treatment plant is not overloaded hydraulically by the incoming rainwater and sewage. The rainwater collected in it is highly contaminated, especially after long drying periods, and solids can settle on the tank floor due to the often longer residence times. Direct-drive Wilo submersible mixers ensure continuous suspension of possible deposits. The compact design allows them to generate the right turbulences – even down to very low water levels. That allows the stormwater retention tank to be drained completely.

Maximum performance in minimum space.

To prevent solid material settling in the pump chamber, a continuous suspension is necessary. The high-speed Wilo submersible mixers have proven themselves in these applications. The direct-drive mixers are so compact that they are easy to install and submerge, even in the tightest spaces. Retrofitting in existing constructions is also easy. For this purpose, Wilo submersible mixers can be installed on the discharge pipeline via a flexible pipe bracket.

Advantages for our customers at a glance:

- Low cleaning work during basin draining owing to installation close to the ground
- Low clogging rate and reliable operation thanks to optimised hydraulics
- Low-wearing, due to the use of stainless steel precision-cast propellers with the lowest cavitation tendency
- A wide range of possible uses in diverse applications, even at high-interval running times
- Reduction of the energy and operating costs due to the standard use of IE3 motors for the best possible thrust coefficient
- High flexibility thanks to the most diverse installation options and accessories

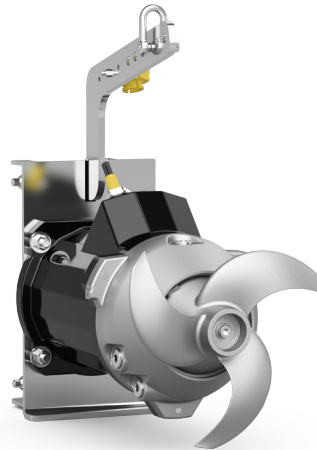

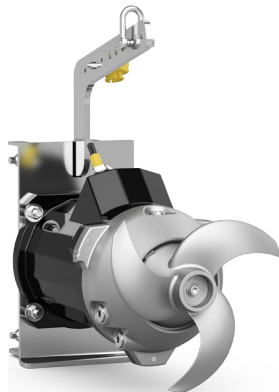

Wilo-Flumen EXCEL-TRE series with IE3 motor



Fast running and compact submersible mixer, directly driven

- Low cleaning effort: due to installation close to the ground, deposits are prevented during emptying of basins
- Low clogging rate and reliable operation thanks to optimised hydraulics
- Low-wearing, due to the use of stainless steel investment-cast propellers with the lowest cavitation tendency
- A wide range of possible uses in diverse applications, even at high-interval running times
- Reduction of the energy and operating costs due to the standard use of IE3 motors for the best possible thrust coefficient
- High flexibility thanks to the most diverse installation options and accessories



Wilo-Flumen OPTI-TR 20-1...40-1



Fast running and compact submersible mixer, directly driven

- Low cleaning effort: due to installation close to the ground, deposits are prevented during emptying of basins
- Low clogging rate and reliable operation thanks to optimised hydraulics
- Low-wearing, due to the use of stainless steel investment-cast propellers with the lowest cavitation tendency
- A wide range of possible uses in diverse applications, even at high-interval running times
- High flexibility thanks to the most diverse installation options and accessories



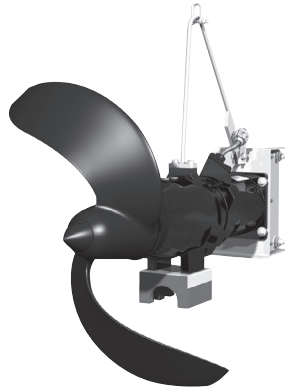

Wilo-EMU TR 50-2...120-1



Submersible mixer with single-stage planetary gear

- Secure your processes
The planetary gear has large dimensions so that the mixing forces are absorbed efficiently
- Efficient energy usage.
The innovative blade geometry ensures the best possible specific thrust coefficient. At the same time, this reduces your energy and operating costs
- Reliable operation.
Clogging-free operation with backward-curved incoming flow edge



Wilo-EMU TR 212... – TR(E) 326...



Slow-running submersible mixer with two-stage planetary gear reduction

- Efficient energy usage.
The innovative blade geometry and energy-efficient IE3/IE4 motors ensure the best possible specific thrust coefficient. At the same time, this reduces your energy and operating costs
- Consistently reliable.
The low-wearing GFK/PA6 propeller is durable and scores with its self-cleaning effect
- Smooth running thanks to the balanced propeller load, even in high thrust ranges and when incoming flow conditions are unfavourable





Wilo-Vardo WEEDLESS



Low-speed vertical mixer with gear motor

- Optimum agitation in basin with square or rectangular floor plan
- Operational reliability owing to wear-resistant propeller
- Easy installation for existing systems
- Floating version for basins with alternating water levels

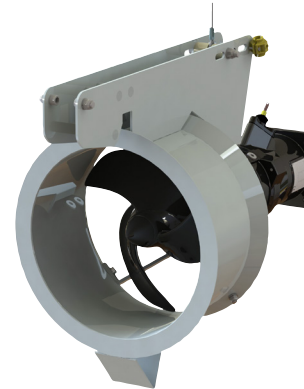

Wilo-EMU RZP



Wastewater Treatment

- Vertical or in-line installation possible
- Self-cleaning propeller to avoid clogging
- Propeller in steel or PUR

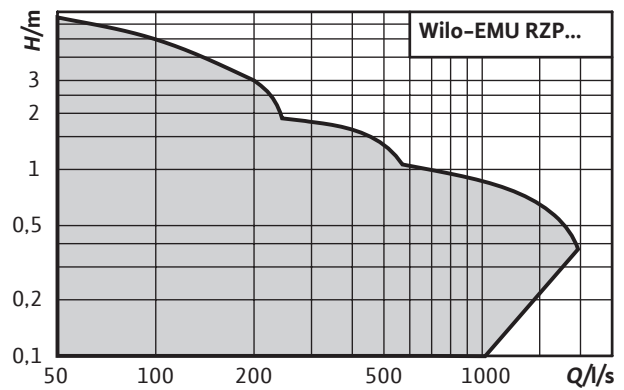



EFFECTIVE SOLUTIONS FOR CRYSTAL CLEAR RESULTS.

Wilo-Sevio AIR

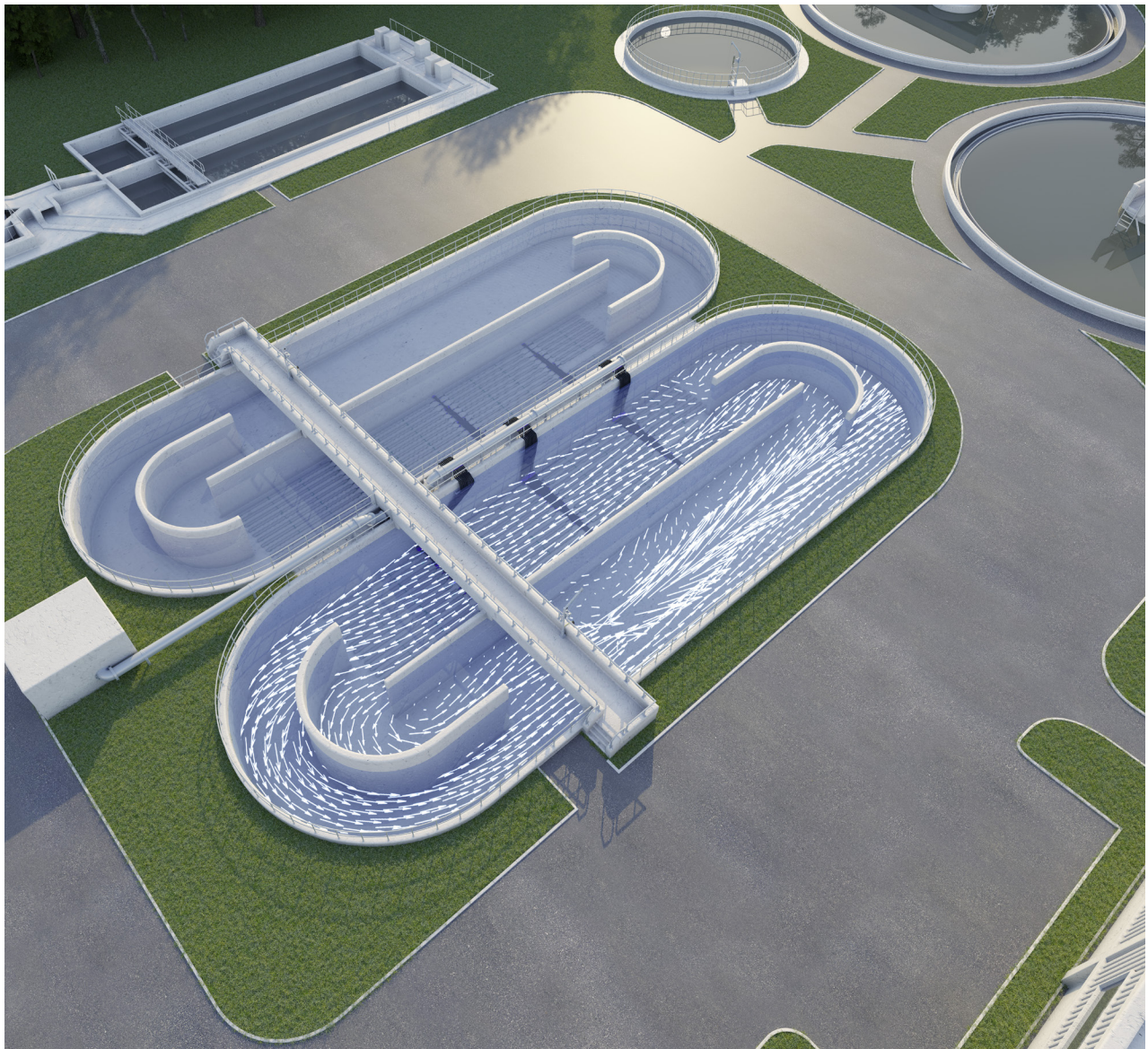

For optimised oxygen entry in your application.

The aeration system has the largest energy requirements in a wastewater treatment plant, consuming between 60 and 80 % of the overall energy required. The right design of the aeration system with fine-bubble aerators is the basis for efficient operation of your wastewater treatment plant. There is often a high savings potential in existing facilities. This means that modernising your aeration system can significantly increase the overall efficiency of your system. Your overall system can be fully adapted to every need, in combination with Wilo mixers.

Adaptable.

Our efficient aeration systems can be adapted to existing systems. This means that we are able to modernise your system so that existing components can continue to be used. This reduces the cost during conversion of existing pipework and reduces modernisation costs overall.

Resistant and durable.

Together with you, we will select a suitable diaphragm material depending on your industrial or municipal sewage properties. This will ensure efficient oxygen entry over many years.

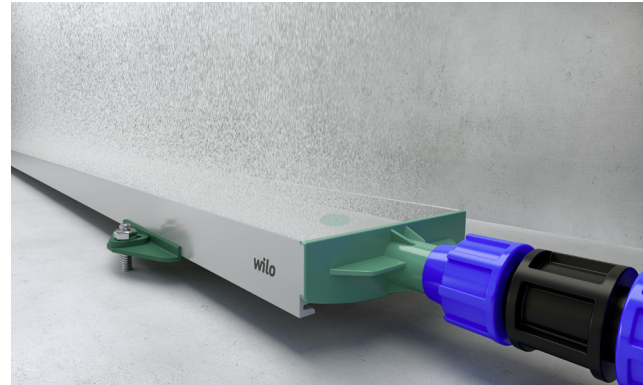

Fine-bubble Wilo-Sevio AIR P aerator for extremely high energy-efficient oxygen entry thanks to micro-perforation and maximum bubble retention time.

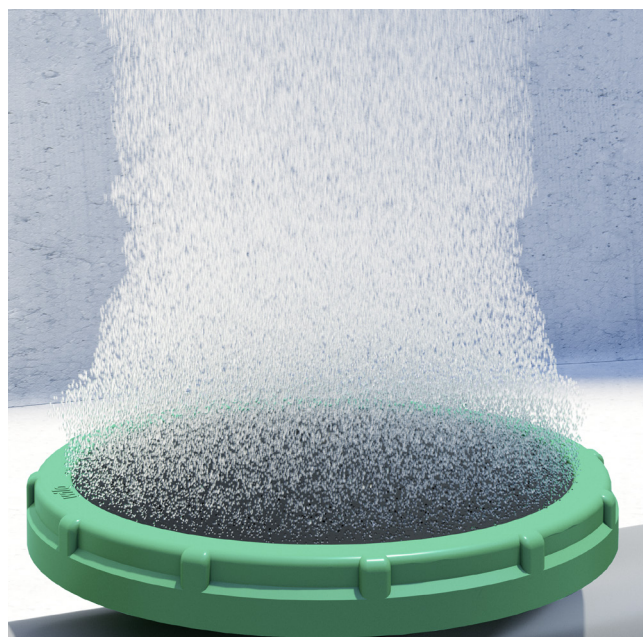
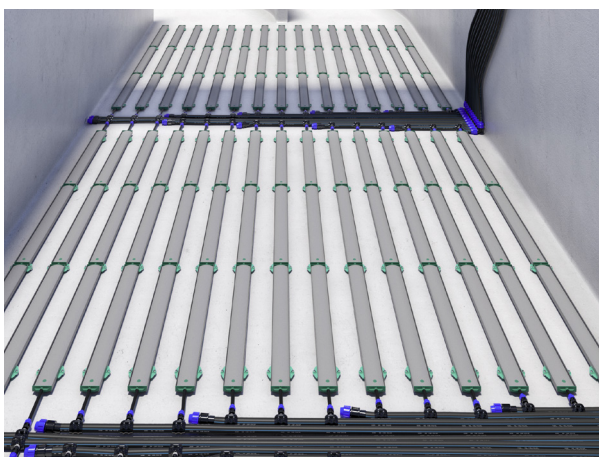
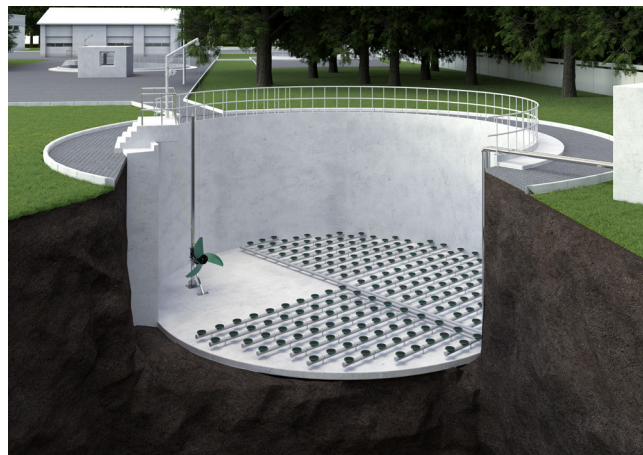

A perfectly designed aeration system with fine-bubble aerators is a prerequisite for efficient operation.

Energetically efficient.

- Micro-perforation for fine-bubble aeration. This means that oxygen can be added with the lowest possible air volume flow.
- Highest possible aeration level for different basin geometries. Each individual aerator is only subject to a low load and therefore operates efficiently.
- Wider control range for load-sensitive oxygen requirements.

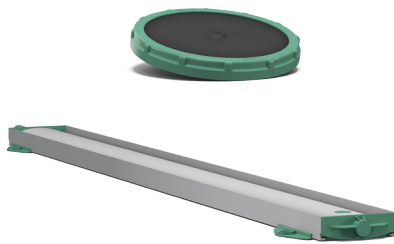

Wilo-Sevio AIR



Aeration system with panel or disc diffusers

Disc diffuser

- High system efficiency owing to high ventilation capacity
- High flexibility in the system control through large control range of the air intake
- Greatest possible, process-specific activation density by taking different basin geometries into account
- High service life in municipal and industrial applications owing to different diaphragm material
- Low installation and conversion costs of the existing pipework

Panel diffuser

- Maximum possible energy efficiency through micro-perforation and large diaphragm surface
- High degree of system efficiency through increased dwell time of oxygen owing to installation close to the floor
- High process reliability through low-wearing and clogging-free diaphragm and integrated non-return valve
- High operational reliability due to sub-division into small aerator fields
- High flexibility in the system control through large control range of the air intake



Wilo-Sevio ELASTOX



Aeration system with panel, tube or disc diffusers

Disc diffuser

- High system efficiency through a high specific oxygen entry at a low pressure loss thanks to optimal diaphragm perforation
- High process reliability through lift restriction of the diaphragm with integrated spring-mounted non-return valve
- High flexibility in the plant control system through the air intake's large control range.
- Maximum possible process-specific activation density by taking different basin geometries into account.
- Long service life in municipal and industrial applications thanks to different diaphragm materials.

Panel diffuser

- High system efficiency through a high specific oxygen entry at a low pressure loss thanks to optimal diaphragm perforation
- High process reliability thanks to low-wearing, clogging-free diaphragm
- High operational reliability through an integrated non-return valve thanks to the diaphragm's excellent resilience and ability to seal the aerator.
- High flexibility in the plant control system through the air intake's large control range.

Tube diffuser

- Highly flexible configuration for the best possible system design thanks to different port-to-port lengths and the air intake's large control range.
- High oxygen entry with less pressure loss thanks to the special perforation of the diaphragm.
- Long service life in municipal and industrial applications thanks to different diaphragm materials.
- High operational reliability, even in unventilated phases thanks to the special pipe design.



Wilo-Sevio ACT



Wastewater Treatment, industrial process

- Sparing entry of the biomass carrier parts into the fluid
- Efficient due to increased volume of penetration for an optimised treatment process
- Reduced energy costs with improved cleaning performance
- Also available with energy-efficient IE3 motor technology
- Retrofittable in existing systems



Wilo-Savus OPTI-DECA



A positive control decanting unit which is decoupled from the fluid

- Effective phase separation to ensure the sewage is cleaned to a high quality
- High process reliability owing to permanently installed system which is decoupled from the fluid
- Universally customisable and modifiable decanting technology owing to individually system-tailored design
- No contamination thanks to process-related cycling of the decanting process



Wilo-EMU FA WR



Wastewater Treatment

- Mechanical mixing device made of Abrasit material to avoid deposits in the pump chamber
- Low vibrations and long service life thanks to high-quality components
- Customised versions are possible

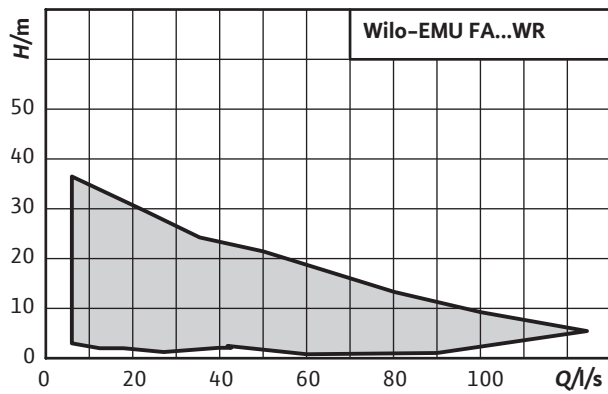



AUTOMATICALLY INCREASES SAFETY AND EFFICIENCY DURING BIOLOGICAL SEWAGE TREATMENT.

THE NEW WASTEWATER TREATMENT PLANT CONTROL SYSTEM
Wilo-TP Control

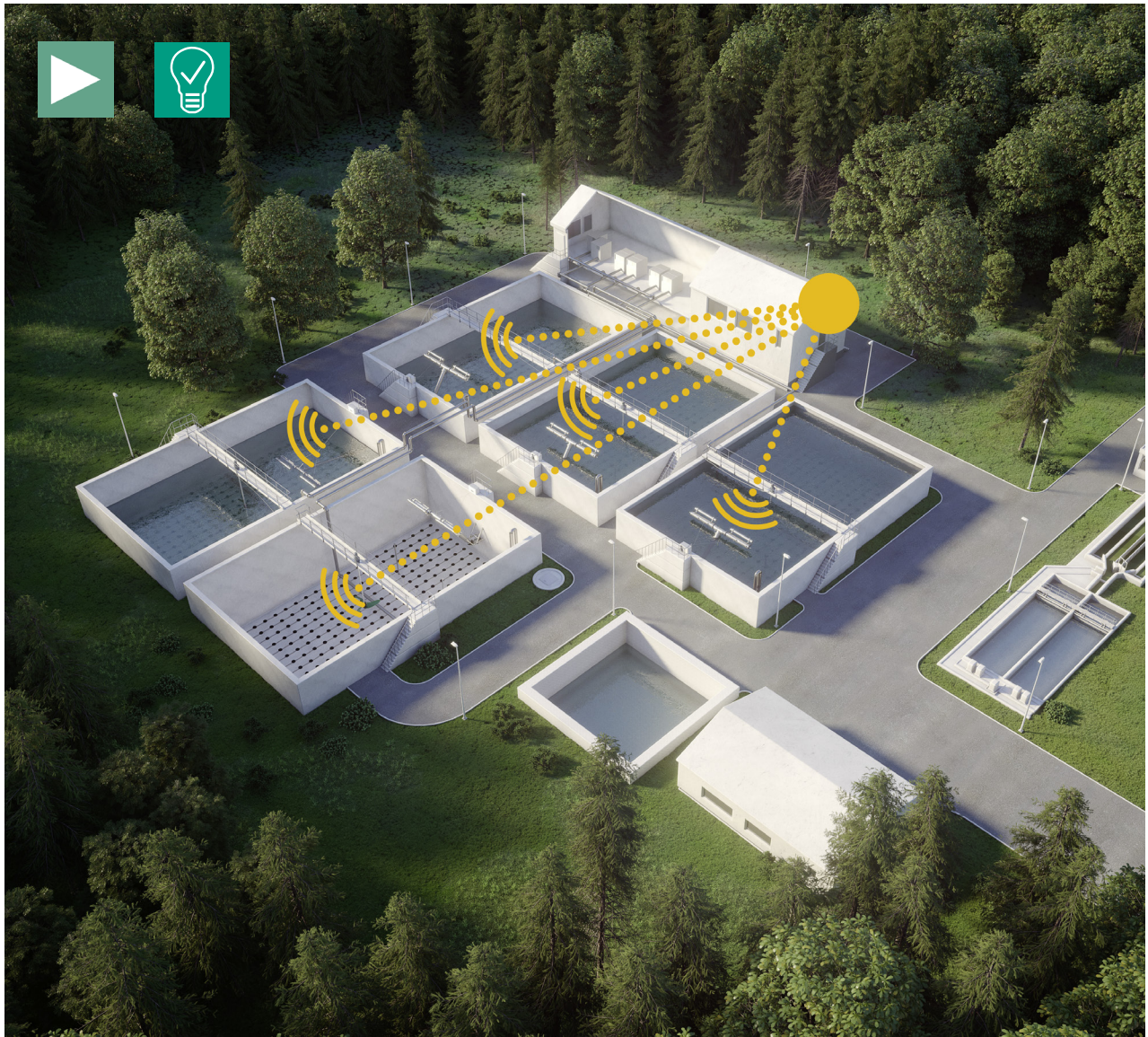

The new control system for wastewater treatment plants, Wilo-TP Control, monitors and controls almost all relevant procedures. Consequently, this intelligent control system merges the three most important aspects of a wastewater treatment plant in one application: process automation, process reliability and process documentation. As a result, plant operators are provided with a reliable, rule-based system control that makes day-to-day operation easier.

Depending on the selected process technology, the control system is individually configured to match any application case. The condition of the sewage in terms of parameters such as oxygen, redox potential, temperature, pH value, conductivity and turbidity are measured as the initial basis using sensors that send values to the control system which compares the live data to what has been configured in advance. In the event of deviations, the system automatically intervenes so that the different treatment stages as part of biological wastewater treatment, such as nitrification and denitrification, transfer processes, return activated sludge transfer, decanting processes, surplus sludge extraction and the adding of precipitants and auxiliary materials are ideally matched.

The Wilo-TP Control for wastewater treatment plants manages the complex interaction of biological, chemical, hydraulic, machine-based and regulating-technology components to guarantee ideal process conditions. This safeguards the best possible system operation and also facilitates day-to-day wastewater treatment plant operation.

Wilo experts completely deliver and install the innovative wastewater treatment plant control including all software and hardware components. Commissioning, function test and system optimisation round off Wilo's range of services. The control system can also be integrated into existing process management systems.

Advantages for our customers at a glance:

- Innovative control system, individually configured for each wastewater treatment plant – schematic visualisation for a perfect overview
- Daily work made easier and more convenient for system operators
- Permanent monitoring of wastewater characteristics and treatment steps – daily logging of events and long-term control over process data
- Increase in operational reliability through early detection of internal and external influence factors
- Simple, clear presentation of all process-relevant data
- Daily logging of events and long-term safeguarding of process data
- Automatic adjustment of machinery operating statuses during intake fluctuations and, as a result, optimal coordination of machine technology
- Avoidance of spikes and control of load differences or manual interventions
- Constant monitoring and rapid localisation of faults
- Energy use proportional to achievement of optimum treatment targets and best sludge quality
- Optional data mirroring in the cloud
- Secure data transfer and remote monitoring via Ethernet or Profinet, other bus systems optionally available upon request

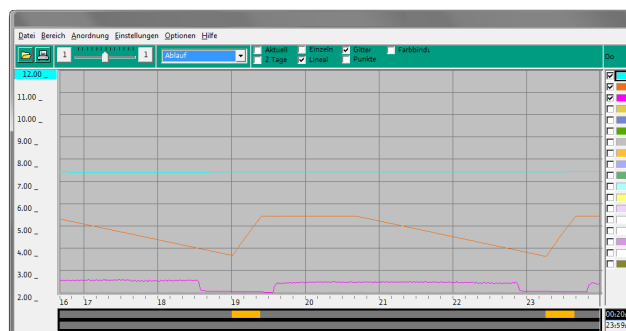

Wastewater treatment

Wilo Services.

Our full-service package for you as partners.

With Wilo as your partner, you can not only be sure of choosing high-quality product solutions but also of benefiting from a comprehensive, worry-free package of well thought out services. This means that we support you personally in every project phase, from design and configuration right through commissioning and maintenance. In our seminars we tell you about the very latest technologies and trends. And when it comes to attractive conditions for your projects, we also have just the right package to offer.

In short, Wilo is always by your side. In person and on the spot. With local services in over 60 countries and more than 1,200 Wilo engineers worldwide.

We make the design and selection process simple for you.

We do not want you to select any solution, but the one that exactly meets your requirements. As a result, we work through your requirements with you before the purchase and, based on this, we prepare the individual product solution that is most economical for you.

Pre-sales services for your tailor-made choice:

- Local support
- Design support
- Product selection
- Selection programmes
- Digital flow simulations
- Flow calculation
- Pipe calculation
- Installation drawings
- Documentation



**“Services
that provide
comprehensive
and reliable
support.**

**That’s what we call
Pioneering for You.”**

For more information, go to
www.wilo.com/en/watermanagement

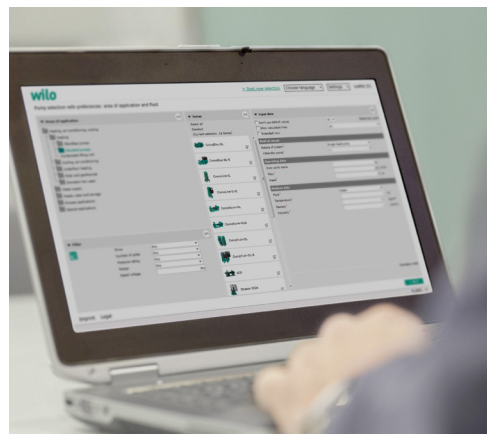

You cannot go wrong with Wilo.

When you have made your choice, we provide you with thorough advice on your investment. What is more, we do not just deliver your solution, we continue to support you – from certification right through to commissioning. For example, qualified plant engineers with years of experience will carry out an extensive test and training phase with our pumps.

Sales services that really work for you.

- Certification
- Acceptance testing at the plant
- Commissioning
- Start-up

→ Wilo-Financial Services.

We help you with the financial implementation of your projects, and gladly create a quotation specially tailored for your investment.

→ Try & Buy

Try & Buy lets you play safe with your investments. Choose a no-risk trial for up to six months to convince yourself of the quality of Wilo's products.

Try & Buy is only available in participating Wilo subsidiaries. Please contact your Wilo sales representative for local options of Try & Buy.



We are there for you. Even after the purchase.

Our tailor-made service solutions cover the entire lifecycle of your Wilo products – including what comes after your purchase. That is why we have professional service engineers available for you locally and globally so that we can supply spare parts quickly and reliably at any time, and why we provide targeted training courses among other things to enhance your expertise. And we continually strive to improve our services.

After-sales services with real added value for you!

- Customised, reliable maintenance concepts
- Rapid repair service
- Fast spare parts solutions
- Efficiency check
- Specific training courses

→ WiloCare

Our service offer for guaranteed operational reliability and cost certainty. Monthly reports keep you up to date on how your system is doing: system status, energy consumption, possible optimisations and pending maintenance intervals. Wilo can offer you individually tailored services in various packages at a fixed monthly price. These allow you to check how reliable your processes are at any time – both in terms of technology and costs.



The Wilo Spare parts catalogue: fast, intuitive and modern.



The Wilo spare parts catalogues meet the latest technical and visual standards and provide all of the important information on our products.

The optimised search function and diverse filters can be used to find the right spare parts by means of article number or part designation.

Our spare part drawings and specially highlighted explanatory texts assist you in selecting the correct spare part.

Drawings and spare parts lists can be conveniently created as PDF documents with just one click.

You can freely access our spare parts catalogue via the Wilo website or directly at the following address:

<https://spareparts.wilo.com> for international customers

<https://ersatzteile.wilo.de> for German customers

All of the functions are also available on mobile devices, meaning that there are no obstacles to searching for spare parts on-site.

Wilo-Quickfinder Series

Raw Water Intake

Wilo-Actun ZETOS K	12
Wilo-Actun OPTI MS	12
Wilo-Sub TWI 4 -...- QC	13
Wilo-Sub TWI 4	13
Wilo-Sub TWI 6	14
Wilo-Sub TWI 8	14
Wilo-Sub TWI 10	15
Wilo-EMU 10" ...24"	15
Wilo-EMU-Polderpumpen	16
Wilo-CronoBloc-BL	20
Wilo-CronoNorm-NL	20
Wilo-CronoNorm-NLG	21
Wilo-VeroNorm NPG	21
Wilo-SCP	22
Wilo-Vertical Turbine	2

Distribution and Boosting

Wilo-SiBoost Smart 1 Helix VE	28
Wilo-SiBoost Smart (FC) Helix V	28
Wilo-Comfort-Vario COR-1 MVIE.../VR	29
Wilo-Comfort-N-Vario COR-1 MVICE...-GE ...	29
Wilo-Comfort-Vario COR-1 MHIE...-GE	30
Wilo-Economy CO-1 Helix V.../CE+	30
Wilo-Economy CO/T-1 Helix V	31
Wilo-Economy CO-1 MVI.../ER	31
Wilo-Economy CO-1 MVIS.../ER	32
Wilo-SiBoost Smart Helix VE	32
Wilo-Comfort COR Helix VE.../CCe	33
Wilo-Comfort-Vario COR MVIE.../VR	33
Wilo-Comfort-N-Vario COR MVICE.../VR	34
Wilo-Comfort-Vario COR MHIE.../VR	34
Wilo-Comfort CO-/COR-Helix V.../CC	35
Wilo-Comfort-N CO-/COR-MVIS.../CC	35

Wilo-Economy CO-MHI.../ER	36
Wilo-FLA-1	36
Wilo-FLA-2	37
Wilo-FLA Compact-1 Helix V	37
Wilo-FLA Compact-2 Helix V	38
Wilo-Helix EXCEL	39
Wilo-Helix VE	39
Wilo-Helix V	40
Wilo-Helix FIRST V	40
Wilo-Multivert MVIE	41
Wilo-Multivert MVI	41
Wilo-Multivert MVICE	42
Wilo-Multivert MVIS	42
Wilo-Economy MHIE	43
Wilo-Economy MHI	43
Wilo-Economy MHIL	44
Wilo-Multivert MVIL	44
Wilo-Zeox FIRST	45
Wilo-Stratos GIGA	46
Wilo-VeroLine-IP-E	46
Wilo-CronoLine-IL-E	47
Wilo-VeroLine-IPL	47
Wilo-CronoLine-IL	48
Wilo-BAC	48
Wilo-CronoBloc-BL	49
Wilo-CronoNorm-NL	49
Wilo-VeroNorm NPG	50
Wilo-SCP	50

Waste Water Collection and Transport

Wilo-Drain MTC	58
Wilo-Rexa CUT	58
Wilo-Rexa UNI	59

Wilo-Rexa FIT	59
Wilo-Rexa PRO	60
Wilo-Drain TP 80/TP 100	60
Wilo-EMU FA (standard pump)	61
Wilo-EMU FA 08...60 (configurable)	61
Wilo-EMU FA (solid)	62
Wilo-Rexa SOLID	62
Wilo-RexaBloc RE	63
Wilo-RexaNorm RE	63
Wilo-Drain VC	66
Wilo-Drain TMT	66
Wilo-Padus UNI	67
Wilo-Padus PRO	67
Wilo-EMU KS	68
Wilo-DrainLift XL	69
Wilo-DrainLift XXL	69
Wilo-EMUport CORE	70
Wilo-EMUport FTS	70
Wilo-Port 600	71
Wilo-Port 800	71
Wilo-Drainlift WS 1100	72

Waste Water Treatment

Wilo-Flumen EXCEL-TRE series with IE3 motor	78
Wilo-Flumen OPTI-TR 20-1...40-1	78
Wilo-EMU TR 50-2...120-1	79
Wilo-EMU TR 212... - TR(E) 326	79
Wilo-Vardo WEEDLESS	80
Wilo-EMU RZP	80
Wilo-Sevio AIR	84
Wilo-Sevio ELASTOX	84
Wilo-Sevio ACT	85
Wilo-Savus OPTI-DECA	85
Wilo-EMU FA WR	86

**THE FUTURE IS
NOW.**

wilo

Pioneering for You

The paper used for this document comes from sustainably managed forests and certified sources (www.pefc.org).

The printing inks are vegetable oil based.
We used carbon neutral printing.

2201756/500/1809/EN/LD

Deutschland

WILO SE
Nortkirchenstraße 100
D-44263 Dortmund

WiloLine

für Fachhandwerksbetriebe
T +49 231 4102-7070
F +49 231 4102-7666
WiloLine@wilo.com
www.xperts.de

Wilo-PlanerLine

für Planungs- und Ingenieurbüros
T +49 231 4102-7080
F +49 231 4102-7666
PlanerLine@wilo.com
www.planerline.de

WILO SE

Werk Hof

Heimgartenstraße 1-3
D-95030 Hof
T +49 9281 974-550
F +49 9281 974-551
wilo@wilo.com
www.wilo.de

Österreich

WILO Pumpen Österreich GmbH
Wilo Straße 1
A-2351 Wiener Neudorf
T +43 507 507-0
F +43 507 507-19
office@wilo.at
www.wilo.at

Schweiz

Wilo Schweiz AG
Gerstenweg 7
CH-4310 Rheinfelden
T +41 61 83680-20
info@wilo.ch
www.wilo.ch

Technische Änderungen vorbehalten.
Es gelten unsere allgemeinen Liefer- und Leistungsbedingungen (siehe www.wilo.de/agb).