

Submittal Data Sheet

Wilo SCP – Horizontal Split Case Pumps

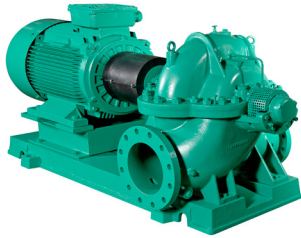

SCP 4 x 3 x 13 HA



Project:	
Engineer:	
Contractor:	
Submitted By:	Date:
Approved By:	Date:

Tag #	Model #	Flow (USGPM)	Head (Feet)	HP	Enclosure TEFC/ODP	Frame	Cycle	Phase	Voltage	RPM
	SCP 4 x 3 x 13 HA						60 Hz	3		

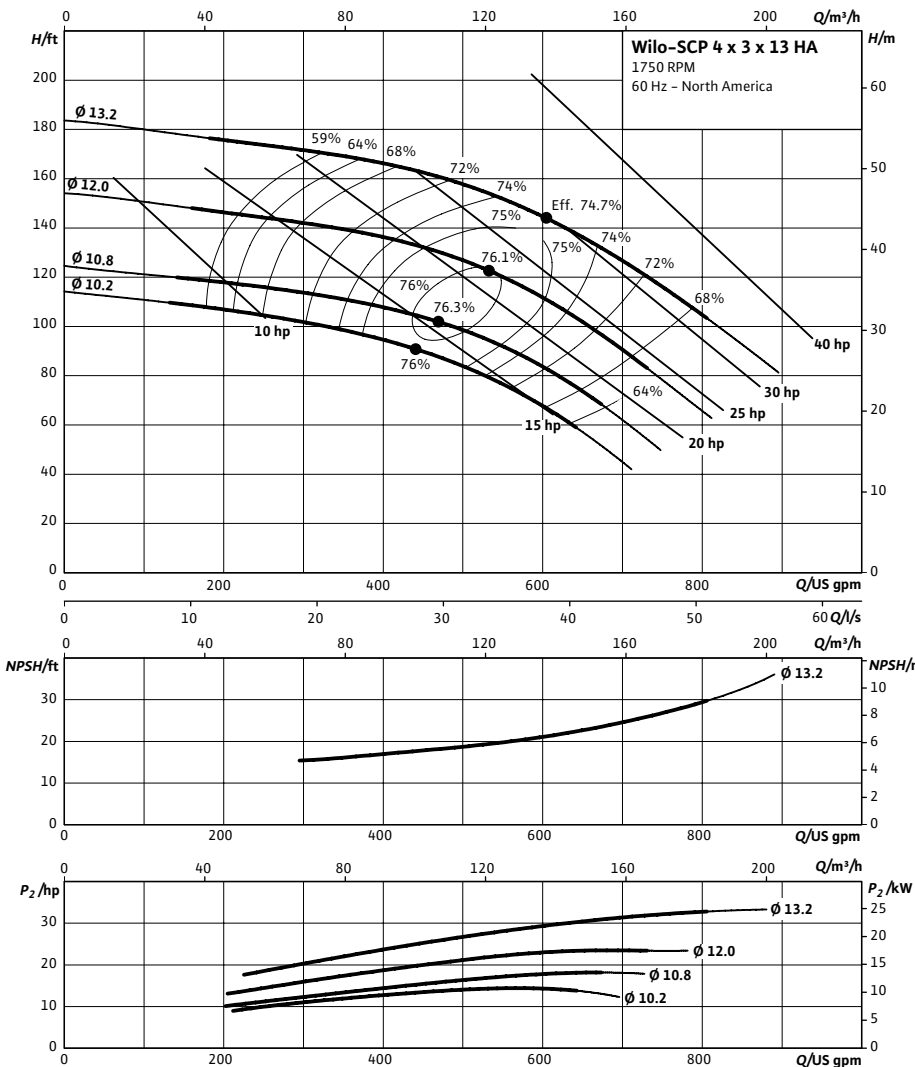

Technical Data

Approved Fluids	
Heating Water	
Cooling and cold water	
Water-Glycol mixtures (for 20-40% glycol and fluid temp ≤ 104°F [40°C])	

Fluid Temperature	
Mechanical Seal	18°F to 250°F (-8°C to 120°C)
Stuffing Box Packing	18°F to 220°F (-8°C to 105°C)

Materials of Construction

<input type="checkbox"/> Pump Housing	A48 Class 35
<input type="checkbox"/> Pump Housing (Optional)	Ni-resist BS 3468 Gr 2 / BS 2789 500.1
<input type="checkbox"/> Impeller	BS 84 C83 600
<input type="checkbox"/> Impeller (optional)	A48 Class 35 / BS 84 C83 600
<input type="checkbox"/> Stationary Wear Rings	BS 84 C93 700
<input type="checkbox"/> Pump Shaft	A276 type 410
<input type="checkbox"/> Pump Shaft (optional)	BS 970 316 S16
<input type="checkbox"/> Mechanical Seal	Carbon/silicon carbide/EPDM (E1)
<input type="checkbox"/> Other Mechanical Seals	Avail. on request
<input type="checkbox"/> Additional Spacer Coupling	Avail. on request
<input type="checkbox"/> Other:	

Approval Stamp

Dimensional Drawing

Single Stage Pump

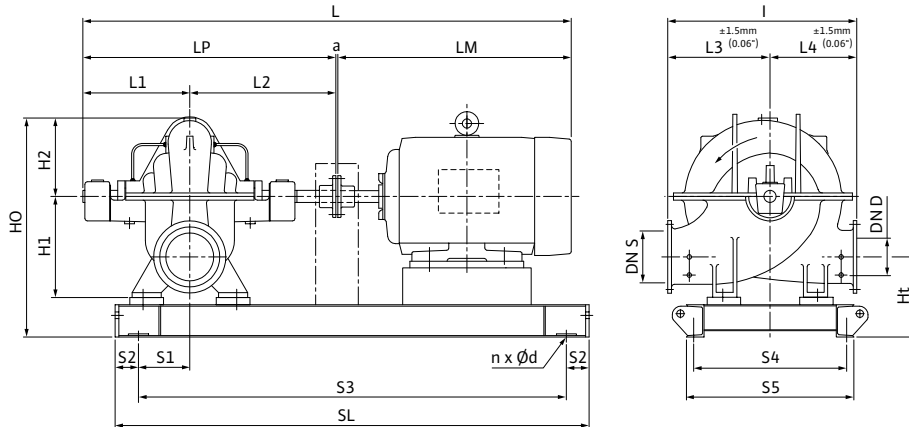

SCP 4 x 3 x 13 HA

Dimensions - Inches (mm)

Frame	a	L	I	L1	L2	L3	L4	LM	LP	H1	H2	HO	Ht	n	Ød	S1	S2	S3	S4	S5	SL	P5	P6
215T	.50 (13)	48.88 (1242)	19.88 (505)	13.63 (346)	15.69 (398)	10.81 (275)	9.06 (230)	19.00 (483)	29.38 (746)	11.81 (300)	8.88 (226)	25.31 (643)	8.56 (217)	4	.91 (23)	1.69 (43)	4.00 (102)	29.88 (759)	10.31 (292)	11.88 (302)	37.88 (962)	-	-
254T	.50 (13)	50.94 (1294)	19.88 (505)	13.63 (346)	15.69 (398)	10.81 (275)	9.06 (230)	21.06 (535)	29.38 (746)	11.81 (300)	8.88 (226)	25.31 (643)	8.56 (217)	4	.91 (23)	1.69 (43)	4.00 (102)	32.63 (829)	12.06 (306)	13.63 (346)	40.63 (1032)	-	-
256T	.50 (13)	53.00 (1346)	19.88 (505)	13.63 (346)	15.69 (398)	10.81 (275)	9.06 (230)	23.19 (589)	29.38 (746)	11.81 (300)	8.88 (226)	25.31 (643)	8.56 (217)	4	.91 (23)	1.69 (43)	4.00 (102)	34.38 (873)	12.06 (306)	13.63 (346)	42.38 (1076)	-	-
284T	.50 (13)	55.81 (1418)	19.88 (505)	13.63 (346)	15.69 (398)	10.81 (275)	9.06 (230)	25.94 (689)	29.38 (746)	11.81 (300)	8.88 (226)	25.31 (643)	8.56 (217)	4	.91 (23)	1.69 (43)	4.00 (102)	36.50 (927)	13.06 (332)	14.63 (372)	44.50 (1130)	-	-
286T	.50 (13)	55.81 (1418)	19.88 (505)	13.63 (346)	15.69 (398)	10.81 (275)	9.06 (230)	25.94 (689)	29.38 (746)	11.81 (300)	8.88 (226)	25.31 (643)	8.56 (217)	4	.91 (23)	1.69 (43)	4.00 (102)	36.50 (927)	13.06 (332)	14.63 (372)	44.50 (1130)	-	-

Flange Dimensions – Suction Side

Dimensions - Inches (mm)

DN S #125	ØD	Ød	Øk	b	n	D2
4	9.00 (229)	6.19 (157)	7.50 (191)	.94 (24)	8	.75 (19)

Flange Dimensions – Discharge Side

Dimensions - Inches (mm)

DND 125#	ØD	Ød	Øk	b	n	D2
3	7.50 (191)	5.50 (140)	6.00 (152)	.94 (24)	4	.75 (19)

